

User's Manual

ZT658

Thank you for purchasing ZTC GSM/ GPRS mobile phone. Please go through this manual carefully to make the best use of your phone.

Contents

1	THE BASIC	7
1.1	INTRODUCTION.....	7
1.2	SAFETY NOTICE.....	8
1.3	FOR YOUR SAFETY	9
	1.3.1 <i>General matters</i>	9
	1.3.2 <i>Phone Safety</i>	12
	1.3.3 <i>Battery Safety</i>	14
	1.3.4 <i>Charger Safety</i>	17
	1.3.5 <i>Cleaning and Maintenance</i>	19
2	BEFORE USE	20
2.1	NAMES OF PARTS AND INTRODUCTION	20
	2.1.1 <i>Technical Parameters</i>	20
	2.1.2 <i>Phone Layout</i>	21
	2.1.3 <i>Keypad Instructions</i>	22
	2.1.4 <i>Introduction to the internal screen</i>	24
	2.1.5 <i>Introduction to the icon</i>	25
2.2	BATTERY.....	26
	2.2.1 <i>Removal and Installation of the Battery</i>	26

2.2.2	<i>Battery Charging</i>	28
2.3	CONNECTING TO THE NETWORK	31
2.3.1	<i>SIM card</i>	31
2.3.2	<i>Removal and Insertion of the SIM Card</i>	32
2.3.3	<i>Removal and Insertion of the Memory Card</i> ..	34
2.3.4	<i>Turning the Phone On and Off</i>	35
2.3.5	<i>Unlocking the SIM card</i>	35
2.3.6	<i>Unlocking the Phone Lock</i>	36
2.3.7	<i>Connecting to the Network</i>	37
3	BASIC OPERATION	39
3.1	FEATURE FUNCTION.....	39
3.2	HOT KEY FUNCTION.....	44
3.3	DIALLING	45
3.3.1	<i>Making Domestic Calls</i>	46
3.3.2	<i>Calling Fixed Line Extensions</i>	46
3.3.3	<i>Making International calls</i>	47
3.3.4	<i>Dialling Calls from the Call Log</i>	48
3.4	EMERGENCY CALLS	49
3.5	RECEIVING CALLS	50
3.6	ENDING A CALL	50
3.7	UNLOCK KEYPAD.....	50
3.8	ADD NEW NAME	50
3.9	VIEW NAMES	51

3.10	CAMERA	52
3.11	ALL CALL HISTORY.....	53
3.12	CALL MENU.....	53
4	FUNCTION MENU.....	56
4.1	HOW TO USE THE FUNCTION MENU	56
4.1.1	<i>Scroll to select Function</i>	56
4.1.2	<i>Shortcut Selecting Function</i>	56
4.1.3	<i>Exit a Menu</i>	57
4.2	STRUCTURE OF THE FUNCTION MENU	57
4.3	NAMES.....	61
4.4.2	<i>Voicemail</i>	84
4.4.3	<i>Broadcast Msg</i>	85
4.5	ZTC PARADISE	87
4.6	WWW	87
4.6.1	<i>Home</i>	88
4.6.2	<i>Bookmarks</i>	88
4.6.3	<i>Push</i>	89
4.6.4	<i>Settings</i>	89
4.6.5	<i>Goto URL</i>	92
4.6.6	<i>Empty Temp files</i>	93
4.6.7	<i>How to Use Online Functions</i>	94
4.6.8	<i>Explanation of the Mobile Phone Keys in the Browser</i>	95

4.7 CALLS.....	96
4.7.1 View Call Log.....	96
4.7.2 Call Timers.....	98
4.7.3 Call Costs.....	98
4.7.4GPRS Info.....	99
4.8 MOVIE PLAYER.....	100
4.8.1 Vidicon.....	100
4.8.2My movie.....	103
4.9 PROFILE.....	104
4.10 SETTINGS.....	106
4.10.1Phone Settings.....	107
4.10.2 Call settings.....	109
4.10.3 Diverts.....	110
4.10.4 Network Settings.....	111
4.10.5 Security Settings.....	113
4.10.6 Reset Settings.....	118
4.11 CAMERA.....	118
4.11.1`Digital Camera.....	119
4.11.2 Album.....	124
4.12 EXTRAS.....	125
4.12.1 Playroom.....	125
4.12.1.1 Fun encyclopedia.....	125
4.12.1.2 MP3.....	126
4.12.1.3 Java.....	127

<i>File viewer</i>	128
<i>4.12.1.6 Record</i>	131
<i>4.12.3 Calculator</i>	132
<i>4.12.4 Clock Setting</i>	133
<i>4.12.5 STK</i>	139
<i>4.12.6 USB Mode</i>	140
5. INPUT MODE	141
5.1 GENERAL OUTLINE	141
5.2 KEYPAD INTRODUCTION	141
5.3 EXPLANATION OF INPUT MODES	143
5.3.1 <i>Pinyin Input Mode</i>	143
5.3.2 <i>Stroke Order Input Mode</i>	146
5.3.3 <i>Stroke Input Mode</i>	151
5.3.4 <i>Smart English input Mode</i>	155
5.3.5 <i>English uppercase and lowercase input mode</i>	157
5.3.6 <i>Number input mode</i>	160
6. TROUBLESHOOTING	162
4	168

1 The Basic

1.1 Introduction

Thank you for choosing the ZT658 ultra slim GSM/GPRS digital mobile phone. After reading this guide you will be able to fully master the use of your ZT658 mobile phone and appreciate all its functions and ease of use.

ZT658 ultra slim mobile phone is designed for use on the GSM/GPRS networks. Not only does the ZT658 provide you with basic calling functions, but also with many practical functions such as English and Chinese predictive input, a name card style phonebook, incoming call pictures and rings, MMS, SMS, clock/alarm, calculator, automatic power on/power off, Java, Journey, STK, GPRS surfing, MP3, file management, keypad guard mobile QQ, recorder, PC-Camera, information code, digital camera and vidicon to improve the time you spend working and playing. Moreover, the ZT658 uses a personalized man-machine interface and the perfect functional design will satisfy all your needs.

The ZT658 ultra slim mobile phone is compatible with GSM/GPRS technology and has been approved by

certification authorities both domestically and abroad.

Note: “Our Company” reserves the right to revise this manual content without prior notice.

1.2 Safety Notice

- If your mobile phone is lost or stolen, please contact the telecommunications authorities or a sales agent immediately to forbid the use of SIM card. This will prevent economic loss caused by unauthorized calls made from your mobile phone.
- When you contact the telecommunications authorities or a sales agent, they will need to know the IMEI number of your mobile phone (remove battery to expose number located on the label on back of phone). Please copy this number and keep in a safe place for future use.
- In order to avoid the misuse of your mobile phone please take the following preventative measure: Set the PIN number of your mobile phone's SIM card and change this number immediately if it becomes known to a third party.

1.3 For Your Safety

Please read these safety guidelines before using your mobile phone to assure the safe and proper use of the phone.

1.3.1 General matters

- Please turn off your mobile phone on airplanes, in hospitals and in other locations with restricted mobile phone use, otherwise the normal operation of electrical equipment and medical instruments will be affected. Please obey local regulations when using your mobile phone.
- While driving please obey local laws and regulations with regard to mobile phone use. When talking on the phone while driving, please obey the following rules: Concentrate on driving and be aware of traffic conditions; if your mobile phone has a hands-free function, please use it in this mode. Under poor driving conditions, please stop the car before you dial or pick up the phone.
- Please obey laws, regulations and signs when near an area storing fuel, chemicals, or volatile

materials.

- Please keep mobile phones, batteries and chargers away from children, to prevent them from injuring themselves with them.
- In order to prevent damage to your mobile phone, only accessories, designated by your manufacturer such as batteries and charge, may be used with your mobile phone. The use of other batteries or chargers could result in battery leakage, overheating, cracking, fire or other malfunctions.
- Please do not use your mobile phone near low signal or precision electronic equipment. Radio wave interference may cause the malfunctioning of such electronic equipment and other problems. Special attention must be paid near the following equipment: hearing aids, pacemakers and other electronic medical equipment, smoke detectors, automatic doors and other automatic control installations. To find out the effect of mobile phones on a pacemaker or other piece of electronic medical equipment please contact the manufacturers

or local sales agents of the equipment.

- This mobile phone is equipped with an auto power on function. Please refer to the mobile phone's clock setting to assure that the mobile phone will not automatically turn on during a plane flight.
- To avoid the mobile phone malfunctioning, or catching fire, please do not violently impact, jolt or throw your mobile phone.
- Please do not place the batteries, mobile phone or charger in a microwave oven or high-pressure equipment. Otherwise it could lead to unexpected accidents such as damage to the circuitry or fire.
- Please do not use your mobile phone near flammable or volatile gases, otherwise it could cause malfunctioning or fire.
- Please do not put your mobile phone at high temperatures, high humidity or dusty places, otherwise this may lead to the malfunction of your mobile phone.
- To avoid your mobile phone falling and malfunctioning or being damaged, please do

not place your phone on uneven or unstable surfaces.

- Please use only the antenna that originally comes with the mobile phone or one that is approved by your manufacturer. An unapproved antenna, or the refitting or an addition to the attached antenna could damage the mobile phone. Please do not touch the antenna when making a call. Touching the antenna will affect the call quality and cause the phone to operate at a higher power level than needed by normal use. Moreover, using an unapproved antenna may be in violation of the regulations of the country you are in.

1.3.2 Phone Safety

- Do not disassemble or modify the mobile phone, as it will lead to damage to the phone such as battery leakage or circuitry failure.
- Please do not subject the LCD to impact or use the screen to strike things, as this will damage the LCD board and cause leakage of the liquid crystal. There is a risk of blindness if

the liquid crystal substance gets into the eyes. If this occurs rinse eyes immediately with clear water (under no circumstances rub your eyes) and go immediately to a hospital for treatment.

- Under very rare circumstances using the mobile phone in certain model cars may negatively effect the internal electronic equipment. In order to assure your safety under such circumstances please do not use the mobile phone. If your car is equipped with an airbag, please do not place your phone on top of, or within the contact area of the airbag in order to avoid seriously harming the driver or passenger when the airbag inflates.
- Please do not use needles, pen tips, or other sharp objects on the keypad as this may damage the mobile phone or cause it to malfunction.
- If the antenna is damaged, please do not use the mobile phone to avoid injury.
- Avoid letting the phone come into close contact with magnetic objects such as

magnetic cards as the radiation waves of the mobile phone may erase the information stored on floppy disks, pay cards and credit cards.

- Please keep small metal objects, such as thumbtacks, far away from the receiver. When the receiver is in use it becomes magnetic and may attract these small metal objects and thus these may cause injury or damage on the mobile phone.
- Avoid having the mobile phone come into contact with water or other liquids. If liquids enter the phone, this could cause a short circuit, battery leak or other malfunction.
- As much as possible, please use the mobile phone in a place away from landline telephones, televisions, radios, and automated office equipment in order to avoid affecting both the equipment and the mobile phone.

1.3.3 Battery Safety

- Do not disassemble or modify the battery, as this will cause the battery to leak, overheat,

crack and catch fire.

- Do not dispose of old batteries with everyday domestic garbage. Please dispose of old batteries at the directed places with specific rules for their disposal.
- Please do not put/throw batteries into a fire, as this will cause the battery to catch fire and explode.
- When installing the battery, do not use force or pressure, as this will cause the battery to leak, overheat, crack and catch fire.
- Please do not use wires, needles or other metal objects to short-circuit the battery. Also, do not put the battery near necklaces or other metal objects, as this will cause the battery to leak, overheat, crack and catch fire.
- Please do not solder the contact points of the battery, as this will cause the battery to leak, overheat, crack and catch fire.
- If the liquid in the batteries goes into the eyes, there is a risk of blindness. If this occurs do not rub the eyes, but immediately rinse eyes with clear water and go to the hospital for

treatment.

- Please do not use or place the batteries near high temperature places such as near a fire or heating vessel, as this will cause the battery to leak, overheat, crack and catch fire.
- If the battery overheats, changes colour, or becomes distorted during use, charging, or storage, please stop using and replace it with a new battery.
- If the liquid from the battery comes in contact with skin or clothing this could cause burning of the skin. Immediately use clear water to rinse and seek medical attention if necessary.
- If the battery leaks or gives off a strange odour, please remove the battery from the vicinity of the open fire to avoid a fire or explosion.
- Please do not let the battery become wet as this will cause the battery to overheat, smoke and corrode.
- Please do not use or place batteries in places of high temperature such as in direct sunlight, as this will cause the battery to leak and

overheat, lower performance, and shorten the battery's life.

- Please do not continuously charge for more than 24 hours.
- Please place the battery in a cool, shady and well-ventilated place out of direct sunlight.
- The life of all mobile phone batteries is limited. The usable time of batteries decreases with frequent charging. When charging becomes ineffective this means that the battery is at the end of its life and the battery should be replaced with a new one of the designated type.

1.3.4 Charger Safety

- Please do not disassemble or modify the charger, as it will lead to bodily harm, electrical shock, fire or damage of charger.
- Please use AC 220 volts. The use of any other voltage will cause battery leakage, fire and cause damage to the mobile phone and charger.
- Please do not use the charger if the power cord is damaged, as this will cause fire or

electrical shock.

- Please clean any dust gathered on the electrical outlet immediately.
- Please do not place vessels with water near the charger in order to avoid water splashing onto the charger and causing an electrical shortage, leakage or other malfunction.
- If the charger comes in contact with water or other liquid the power must immediately be switched off to avoid an electrical short or shock, fire or malfunction of the charger.
- Please do not use the charger in the bathroom or other excessively moist areas, as this will cause electrical shock, fire or damage to the charger.
- Please do not touch the charger with wet hands, as this will cause electrical shock.
- Do not modify or place heavy objects on the power cord, as this will cause electrical shock or fire.
- Before cleaning or carrying out maintenance please unplug the charger from the electrical outlet.

- When unplugging charger, do not pull on the cord, but hold on to the body of the charger, as pulling on the cord will damage the cord and lead to electrical shock or fire.
- Please do not charge in the following places: moist or humid places, dusty places or places with excessive vibration (this will cause malfunctioning); near televisions, radios, electronic products (this will effect the picture and sound)

1.3.5 Cleaning and Maintenance

- The mobile phone, battery and charger are not water resistant. Please do not use them in the bathroom or other excessively moist areas and likewise avoid allowing them to get wet in the rain.
- Use a soft, dry cloth to clean the mobile phone, battery and charger.
- Please do not use alcohol, thinner, benzene or other solvents to wipe the mobile phone.
- A dirty outlet will cause poor electrical contact, lose of power and even inability to recharge. Please clean regularly.

2 Before Use

2.1 Names of Parts and Introduction

2.1.1 Technical Parameters

Phone

Model	ZT658
Dimensions	45mm×102.5mm×12.5mm
Weight	About 75g (with standard battery)

Lithium Battery

Model	ZT658
Standard voltage	3.7V
Limited voltage	4.2V
Nominal Capacity	680mAh
Standby time	about 80-150 hours
Talk time	about 160 minutes

(*depends on the network)

Travel charger

Model	WLW00500001
Input	AC110-220V, 50/60Hz 0.15A
Output	5.0V DC, 400mA

2.1.2 Phone Layout



1.T-flash card plug; 2. Display; 3. Keypad; 4. Receiver; 5.Speaker; 6. Earphone/ charger/ datawire jack; 7. Harness; 8. Camera; 9. Camera viewfinder; 10. Battery cover;

2.1.3 Keypad Instructions

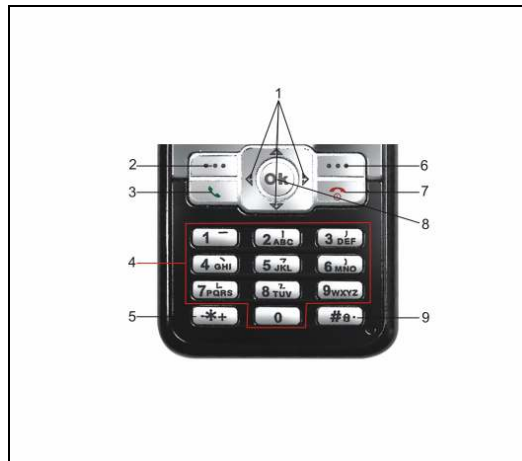

- 1. Left/ right key:** scroll the cursor in editing mode; in standby, press **left key** to access to Messages, press **right key** to access to Profile; in the camera capturing mode, press **left/ right key** to set camera; in main menu, press **left/ right key** to scroll through menu items; in volume modulating mode, press **left/ right key** to increase or decrease the volume.
Up/ down key: scroll to view name, phone number, sub-menu or setting; scroll the cursor

up/ down in editing mode; in standby, press **up key** to access to Extras, press **down key** to access to ZTC Paradise; in main menu, press **up/ down key** to scroll through menu items; in the camera capturing mode, press **up/ down key** to set camera; in volume modulating mode, press **up/ down key** to increase or decrease the volume.

2. **Left Soft key:** Carry out the operation at the down left of display.
3. **Calling Key:** Dial a phone number and answer a call; in standby, show all call lists.
4. **Number Keys:** 0-9 Number keys, enter numbers and characters; select menus directly; 2-9 number keys, can set as speed dials shortcut.
5. ***Key:** Have various functions in different modes and menus.
6. **Right Soft key:** carry out the function at the down right of display; clear character in editing mode.
7. **End Key:** End or reject a call; return to standby mode; press and hold can turn the phone on/ off.

- 8. **Function key:** In standby, press the key to access Movie player interface; in Names lists of phonebook, press the key to operate the current entry.
- 9. **# key:** Have various functions in different modes and menus.

Note: Up/ down/ left/ right key are generally called navigation key.





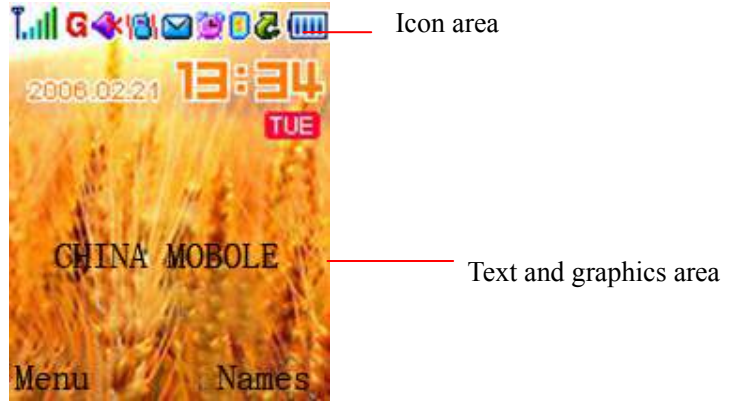



In this manual, Press “xxx Key” means press the definite key then undo it, “Press xxx Key for long time” means press this key for 2 or more seconds.



2.1.4 Introduction to the internal screen



Area	Explanation
First line/Icon area	Displaying the various icons
middle several lines/ Text and graphics area	Displaying and entering the various information
Last line/ Soft key prompt area	Displaying the prompt information for the left/right soft keys

2.1.5 Introduction to the icon

Icon	Name	Display Area
	Strength of signal	Icon area
	GPRS is connected	Icon area
	Mute mode	Icon area
	Vibration Only	Icon area
	You have new message	Icon area
	Divert All Voice Calls is active	Icon area
	Earphone is inserted	Icon area
	Battery indication	Icon area

	Missed call list	left side of Text and graphics area
	Dialed call list	left side of Text and graphics area
	Received call list	left side of Text and graphics area

2.2 2.2 Battery

The battery initially has a charge of about 50% and may be used directly out of the box. A new battery will reach its nominal capacity after fully charged and discharged for about three times.

2.2.1 Removal and Installation of the Battery

- Removing the battery as following steps: 1) Slide the battery cover toward the bottom of the device and remove. 2) After you have removed the back cover, slide the battery, insert your finger into the finger grip and lift the battery from its compartment as the following picture:

Warning: Before removing the cover, always switch off the power and disconnect the charger

and any other device. Avoid touching electronic components while changing the covers. otherwise it may damage SIM Card and your device.

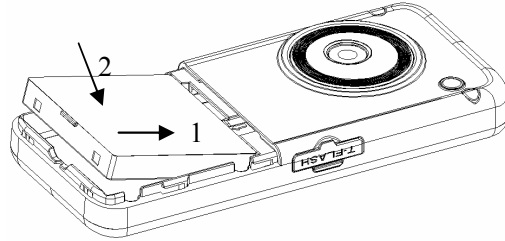

■ Installing the battery as following steps:

- ① Insert the gold-colored contact end of the battery, into the battery slot. Push down on the other end of the battery to snap the battery into place;
- ② Pull out the spring according to the arrowhead, and press the bottom of battery until it is surely inserted to the battery slot...

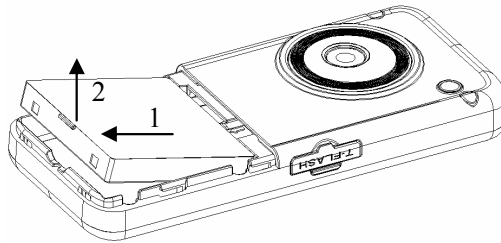

2.2.2 Battery Charging

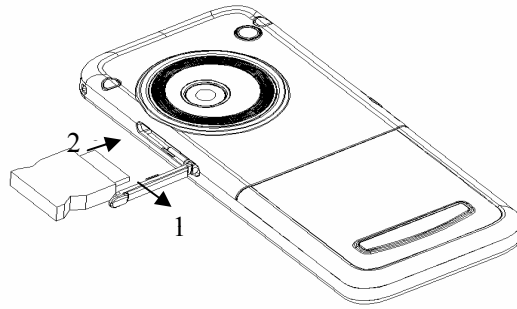

Plug the charger into the electrical outlet.

Plug the charger connector into the bottom of the phone (with the arrow pointing upward).

At this time the charge icon will be shown at the top right corner of the mobile phone's screen; If the mobile phone is charging while power off, a charging indication will appear on the screen. If the mobile phone was used even after there was insufficient power, it might take some time after having begun charging until indication of charging appears on the screen.

When the battery level icon indicates that the battery is full, this means that the battery is fully charged. If charging while power off, there will still be an indication on the screen shows that the charging is complete. This process usually takes about 1 to 2.5 hours. It is normal that the mobile phone and charger will become warm during charging.

When charging is complete, unplug the charge connector from the electrical outlet and the mobile phone.

Note: Charging must be performed in a well-ventilated area with a temperature between -10°C and +55°C. The factory-supplied charger must be used. Using an unapproved charger could be dangerous.

If the mobile phone automatically shuts down, or indicates that the “Battery is low” you should immediately charge the battery. If the battery has not been entirely used up before charging, the mobile phone will automatically decrease the recharging period.

The standby time and calling time provided by the factory are based on ideal working conditions. During actual use, the work time of the battery may change according to the network situation, work environment and mode of use.

2.3 Connecting to the network

2.3.1 SIM card

Before using your mobile phone you must insert a SIM card into the phone. The SIM card is your key to access the digital GSM/GPRS network.

The information recorded on the metal area of the SIM card is all the data related to establishing a connection with the network, together with the names

and numbers in your phonebook and messages. Your SIM card can be removed from your mobile phone and be read in any other GSM/GPRS mobile phone to (a new mobile phone will automatically read the SIM card).

To prevent losing or damaging the data stored on the card, you should avoid touching the metal area on the card and keep the SIM card in a place far away from electricity or magnets. Once the SIM card is damaged, you will be unable to access the GSM/GPRS network.

Warning: Before removing the SIM card you must turn off the mobile phone. Do not insert or remove the SIM card while the phone is connected to an external power source, otherwise the SIM card could be damaged.

2.3.2 Removal and Insertion of the SIM Card

The SIM card is usually located in a plastic card. Before inserting into the phone you must carefully remove it.

- Turn off the phone; remove the battery and

unplug other external power sources.

- Insert the SIM card into the SIM slot as shown in the following picture.

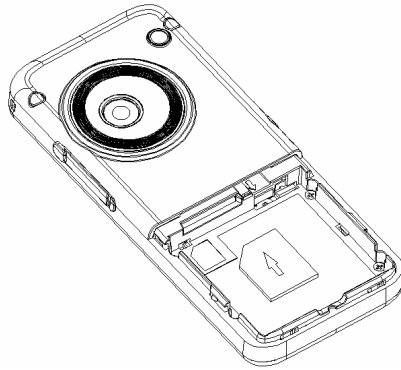

- When you need to remove the SIM card, please turn off the phone firstly, remove the battery, and then remove the SIM card as shown in the following picture.

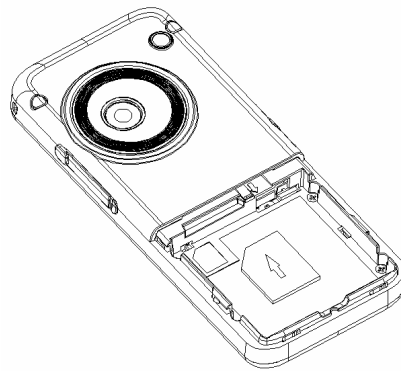

2.3.3 Removal and Insertion of the Memory Card

- Turn off the phone; remove the battery and unplug other external power sources.
- Open the plug of the T-Flash card Jack;
- Insert the T-Flash card as shown in the following picture.
- Close the plug of the T-Flash card Jack;

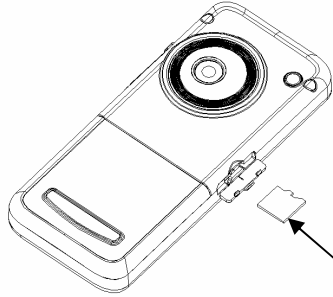

When you need to remove the memory card, please turn off the phone before removing the card;



2.3.4 Turning the Phone On and Off

To turn on or off the phone please press and hold the **End key**.

If you turn on the phone without having inserted the SIM card the phone will display "**Insert SIM**". After inserting the SIM card the phone will automatically check if the SIM is usable.

The following will be displayed in this order:

"**Enter PIN1**" - if you set a SIM card password.

"**Enter lock code**" – if your set a mobile phone password.

"**Searching**" – The phone will conduct a search to find the appropriate network connections.

2.3.5 Unlocking the SIM card

In order to protect against unlawful usage, the SIM card uses a PIN1 (personal identification number) number. If you choose this option, then every time you turn on your phone you must enter the PIN1 so as to unlock the SIM card before you use the mobile phone. The user may turn off the SIM card protection (please refer to "**Security Settings**", section [4.10.5](#)). Under such circumstances you cannot prevent the unlawful

use of the SIM card.

- Press and hold the **End key** to turn on the mobile phone.
- Enter the PIN1 number. Press **Right soft key** to delete incorrect input. Finish with pressing the **left soft key “OK”**. If there are continual wrong enter for three times, your SIM card will be locked by network, and the phone will inquiry PUK.

■

Note: Your network provider will provide your SIM card with a standard PIN1 number (with 4-8 numbers, default as 1234). You should change this to your own number as soon as possible. For details please see “Security Settings” in section 4.10.5.

2.3.6 Unlocking the Phone Lock

In order to protect against unlawful usage, a lock code may be set for your phone. If you choose this option, then every time you turn on your phone, after entering the PIN1 (if you have set a **PIN** number) you must enter the lock code before you may use the mobile phone as normal. The user may turn off the phone lock code protection (please refer to “Security

Settings”, section 4.10.5). Under such circumstances you cannot prevent the unlawful use of your mobile phone.

- Enter the lock code. Press **Right soft key** to delete incorrect input, finish with **left soft key** “**OK**”. The code defaults as 1234. If you forget your lock code, you must contact your retailer or local authorized repair and maintenance service centre to have the lock code opened.

2.3.7 Connecting to the Network

When the SIM card has been successfully opened your mobile phone will automatically search for a useable network (“**Searching**” will be displayed on the screen). When the connection is made, the name of the network provider will appear in the middle of the screen. At this point your mobile phone is on standby, in addition to dialling and receiving calls, you may also perform the following:

- Press the **right soft key** to enter the name card style phonebook.
- Press the **left soft key** to enter the function menu (please refer to chapter 4).

Note: If “**Emergency only**” is displayed on the

screen, this means that you are already outside the normal coverage of the network area, but you can still transmit emergency calls depending on the strength of your signal.

Your phone supports GPRS service. If your network operator has activated your GPRS service and your phone is within the GPRS network area, then there will be a “G” displayed to the right of network signal strength indicator. At this time you may access the WAP service through the GPRS network.

3 Basic Operation

3.1 Feature function

Your mobile phone has various practical functions besides basic voice call.

Brief introduction is as follows:

■ Phone book

You may use the phone book function easily.

Your mobile phone supports:

- a) To search for a desired phonebook entry quickly by name;
- b) To search for a desired phonebook entry quickly by group filter;
- c) To add up to 500 phonebook entries to mobile phone. Every local phonebook entry can include three telephone numbers;
- d) To save a phone book entry to SIM card or mobile phone freely;
- e) To dial the phonebook entry directly;
- f) The following operations on the phone book entry: edit, send a short message to some telephone number of the phonebook entry, copy the phone book entry between SIM card and mobile phone,

- set one key dial-up, blacklist and group, delete;
- g) To view the total memory capacity and occupied memory space of the phone book for both the mobile phone and the SIM card;
- h) To view speed dial list and blacklist;

Note: please refer to “**NAMES**”, section 4.3.

■ **Messages**

You can use the SMS and MMS service through your mobile phone.

Your mobile phone supports:

- a) the following operations on a SMS or MMS message: send, receive, save, forward, delete, edit, reply, respond by call, extract the telephone numbers, keep in the “archived” folder and view the detailed information;
- b) To send one short message consecutively to several people;
- c) To choose the recipient’s telephone number from the phone book entries speedily;
- d) To save up to 200 pieces of SMS onto your handset.
- e) To set the priority of position to save the SMS and view the capacity status of SMS.
- f) To make a series of personalized settings on the

SMS and MMS.

- g) voice mail and broadcast message services;

Note: please refer to “**Messages**”, section 4.4.

■ **ZTC Paradise:** Your handset supports kinds of value-added services by retailers.(Please refer to “**ZTC Paradise**” ,section 4.5)

■ **WWW:** your mobile phone supports WAP service, you can gain much information through WAP browser accessing the wireless network. (please refer to “**WWW**” , section 4.6)

■ **Calls**

You may use call log function.

Your mobile phone supports:

- a) To save received calls, missed calls and dialled calls automatically. You may also clear these call logs;
- b) To view last call time as well as respective accumulated call time of received calls, dialled calls and all calls. You may also clear call time to zero;
- c) To make the settings on call cost. This function is dependent on your network operator;
- d) To auto-save and view the GPRS data flow

quantity.

Note: please refer to “**Calls**”, section 4.7.

■ **Movie player**

You may take movie freely with built-in vidicon.

Your mobile phone supports:

- a) The following personalized settings on vidicon:
Focus, Brightness, Rotation, Image effect;
- b) Quickly to view the movie taken by your vidicon.

Note: please refer to “**Movie player**”, section 4.8.

■ **Profile**

You may use or set one of five profiles related to the mobile phone’s ring tone according to cases and environments.

Your mobile phone supports:

- a) The Normal, Meeting, Outdoor, Car, Silent modes;
- b) To make the following personalized audio settings for each mode: Incoming call ring type, Incoming call ring volume, Speaker volume, Vibrator, Key tones, Warn tone, Message alert, Lid tone type or Power On/Off Ring;
- c) To set the music downloaded from computer as an incoming call ring.

Note: please refer to “**Profile**”, section 4.9.

■ Settings

You may make the following personalized settings according to your usage custom: Language, Wallpaper, backlight, Owner Name and Number, Greeting, Keypad Guard, Message Lock, IP Dialing and area code setting, Any Key Answer, Auto-Answer, Call Waiting, Minute Mind, Call Diverting, Network, SIM and Handset Passwords, Handset and Network Call Bars, Fixed Dialing, Reset Setting and so on.

Note: please refer to “Settings”, section 4.10.

■ Camera

You may take picture freely with built-in digital camera.

Your mobile phone supports:

- b) The following personalized settings on camera: shutter mode, Brightness, Focus, Rotation, Image effect, Photo frame, Picture size, Auto-save and sound;
- c) Time-lapse shot mode of the camera.
- d) Quickly to view the photos taken by your digital camera.

Note: please refer to “Camera”, section 4.11.

■ Extras

You may use various practical functions for your work and life.

Your mobile phone supports:

- a) alarm, Calculator, auto-power-on/off, mobile QQ, recorder, Java, Mp3 player, file viewer, journey and world clock functions;
- b) To set time and date;
- c) STK function.

Note: please refer to “**Extras**”, section 4.12.

■ Input modes

Your mobile phone supports Chinese and English input and provides the following input modes: Pinyin input, Stroke order input, Stroke input, Smart English input, English uppercase input, English lowercase input, Number input, and commonly used symbols input.

Note: please refer to “**Input Modes**”, section 6.

3.2 Hot key function

Function	Hot Key	State
Power On	End key (press and hold)	Power off mode
Power OFF	End key (press and hold)	Power on mode

Access Menu	Main	Left Soft key	Standby Mode
Show List	Names	Right Soft key	Standby Mode
Access menu	Extras	Up Key	Standby Mode
Access paradise	ZTC	Down Key	Standby Mode
Access player interface	Movie	Function key	Standby Mode
Access Messages menu		Left Key	Standby Mode
Access menu	Profile	Right Key	Standby Mode
Show history	All call	Calling Key	Standby Mode
Input number	phone	Number key	Standby mode
End call		End key	During a call
Unlock keypad		Right soft key, then Left soft key	Keypad locked mode

3.3 Dialling

You may dial and receive calls on your phone

when the symbol of your network provider appears on the screen. The information bar on the upper left corner of the screen indicates network strength (the signal is strongest when there are five lines visible).

Barriers greatly affect call quality, thus slightly shifting your location can increase the quality of the phone call.

3.3.1 Making Domestic Calls

Press **number keys** to enter the telephone number, and then press Calling key. If you need to change the phone number, please press **Right soft key** to delete a character at left of the cursor. The dialing animation will appear on the screen during dialing. When the other party picks up the phone, the screen will display information about the call.

Press **End key/Right Soft Key** to end the call.

You can make domestic calls as following order:

Area code Phone Number Calling key

3.3.2 Calling Fixed Line Extensions

Some fixed phone extensions cannot be called directly. You must go through the switchboard before

dialing the extension. When you enter the telephone number, you may add the pause code “P” between the switchboard number and the extension number, this phone will automatically connect you with the extension. The “P” is entered by pressing and holding **# key** (at this time the screen will display the letter “P”).

**Area code switchboard number P
extension number Calling key**

3.3.3 Making International calls

Making international calls you should press and hold the *** key** until the international phone prefix “+” appears on the screen. It will allow you to call from any countries when you don’t know the local international call prefix (e.g. 86 stands for China).

After entering the prefix, enter the country code and full number you wish to call. The country code is according to convention: Germany is 49, England 44, Sweden 46 and so on.

When making international calls, you should omit the initial 0 of area codes.

For example, if you were to dial the Shanghai service hotline, you would dial +86 21 114

+ Country code area code telephone

number Calling key

3.3.4 Dialling Calls from the Call Log

All the calls you make, receive and miss on your phone are saved in the call log of your mobile phone. The recently dialled and received calls are found at the top of the call logs (refer to “**Calls**”, section 4.7). The call logs are categorized into dialled, received and missed calls. Your mobile phone also allows you to look up all recorded calls. When the call log is full, the old numbers are automatically erased. To look up numbers in the log you must follow the key sequences: On standby press **Calling key** to see the record of all numbers.

All the numbers in the log may be dialled directly by using **Calling key**.

When the call log appears, you can press the **left soft key “View”** to see the details of call record, or press **Function key “Menu”** so that you can carry out following functions on numbers in the call log: **“Delete”**, see the **“Detail”**, **“Save”**, **“Add to blacklist”**, **“Messages”** or **“Delete all”**.

3.4 Emergency Calls

- If you are located within the network area (you can find this out by referring to the network strength indicator located on the upper left-hand corner of your mobile phone screen), you should be able to make emergency calls. If your network operator does not provide roaming where you are, **“Emergency only”** will appear on the screen. If you are located within a network area, even if you do not have a SIM card, you will be able to transmit emergency calls.

3.5 Receiving Calls

You can choose different ways to receive calls. If the earphone has been inserted, you can press keys in earphone to answer a call. If you are not convenient to press key, you can set **Auto answer** as "On", the call will be connected after 5 seconds ringing or vibrating. If you set **Any key answer** as **On**, any key can receive calls except **End Key, Right Soft key**.

3.6 Ending a Call

You can press the **end key/right soft key** to refuse an incoming call. During a call you can press the **end key/ right soft key** to end a call. You can also cancel a call you have just dialled by pressing the **end key/ right soft key**.

3.7 Unlock keypad

When **Key Guard** is set as **On** and no operation is made in standby mode, the keypad will lock automatically after a while, press **Right soft key** and then **# key** to unlock the keypad.

3.8 Add new name

In standby, press **Right soft key** to access **Names**,

press **Up/ down key** to select **Add new name** and press **Left soft key** to access, then you can make following operations:

- Press **Up/ down key** to select saving position: **SIM card** or **Phone memory**.
- If select save to **SIM card**, press **Left soft key** “**Select**” to access, press **Up/ down key** to edit **Name** and **Number**, press **Left soft key** to save phone book list.
- If select save to Phone memory, press **Left soft key** “**Select**” to access, press **Up/ down key** to edit **Name, Group, Number, Ring tone, Picture, QQ, E-mail** and **Notes**, press **Left soft key** to save.

Note: When **Names/ Settings/ Save Nos. to** is set as **SIM card** or **Phone memory**, the phone will no longer indicate save position.

3.9 View names

The device has provided speedy view names functions. You can view names by group Filters function or searching name. Operate as follows:

- In standby, press **Right soft key** to access **Names** menu.

- Press **Up/ down key** and **Left soft key** to access Settings / Filters.
- Press **Up/ down key** to select group you need, press **Left soft key** to select check box .
- Press **Right soft key** to return to Names menu.
- Press **Up/ down key** to select **Search**, press **Left soft key** to access.
- Input part or complete name of the number you need, press **Left soft key** to show the relevant number entry with the name you input.



Note: In standby, press **Right soft key** and then **Left soft key** to access Names lists directly.

3.10 Camera

In standby mode, press and hold **Camera release key** to access camera capturing mode, press **Left soft key** or **Camera release key** to shot, press **Left soft key** twice to save photo. You can view the photo by **Camera/ Album** or **Extras/ Playroom/ File viewer/ PHOTOS**.

3.11 All Call history

The device saves recent Missed calls, Received calls, Dialed calls, last call time and all call time for you. (Refer to [4.7](#) “Calls history”).

3.12 Call Menu

During the call, press the **left soft key**, “**Menu**”, to enter the call menu. The call menu is used in the same way as the menu.

The call menu can only be seen while a call is being made. Functions such as call waiting, call hold, and conference calls require network support. Please contact your network provider.

In the call menu you can perform the following operations:

- **“Hold”/“Retrieve”**
To put a call on hold or retrieve a call that has been put on hold.
- **“Swap”**
Change between a call being made and one on hold.
- **“End current”**
End the current call.
- **“Mute”**

- To stop transmitting the user's voice.
- **"DTMF off"**
Deactivate DTMF sound.
- **"DTMF on"**
Activate DTMF sound.
Note: DTMF (dual tone multi frequency) is the signal to the phone company that you generate when you press an ordinary phone's touch keys.
- **"Messages"**
Create a SMS or MMS message.
- **"Names"**
Enter the list of phone book entries.
- **"Multiparty"**
 - **"Answer"**
To pick up a waiting incoming call and join it with a multiparty call
 - **"Join all"**
Add a caller to a multiparty call.
 - **"Hold all calls"**
To put a conference call on hold.
 - **"Private"**
To carry on a call privately with one party while keeping all the other parties on hold.
 - **"Transfer"**
Connect two parties and withdraw oneself from the multiparty call.
 - **"Exclude"**
Put one party of a group on hold.
 - **"I am busy"**

Let a waiting incoming call hear a busy signal.

- **“End all calls”**

End current call and all calls on hold.

Note: Some of options show in certain condition, such as, “Swap” shows only when there are talking call and remained call.

4 Function Menu

4.1 How to Use the Function Menu

4.1.1 Scroll to select Function

On standby, press the left soft key “MENU” to enter the main function menu, use the navigation keys to scroll to a desired main menu and press the left soft key to enter it.

During a call, press the left soft key “MENU” to enter the call menu, then use the up/down keys to scroll to the desired item on the call menu and press the left soft key to select the function.

In all the submenus, use the up/down key to scroll to the desired function and press the left soft key to enter the function item.

4.1.2 Shortcut Selecting Function

Most submenus have shortcut numbers. This shortcut number is the function’s corresponding

index number.

- On standby, press the **left soft key** “MENU” to enter the main menu.
- Enter the submenu’s shortcut number to enter the corresponding item.

4.1.2 Exit a Menu

Usually, when in the function menu, you can exit a menu item by pressing the **right soft key**. You can also press the **End key** to return to the standby mode directly.

4.2 Structure of the Function Menu

The function menu has the following default structure:

- 1 Messages
 - 1-1 Messages
 - 1-1-1 New Message
 - 1-1-2 Inbox
 - 1-1-3 Outbox
 - 1-1-4 Drafts
 - 1-1-5 Sent
 - 1-1-6 Archived
 - 1-1-7 Settings
 - 1-1-7-1 Default message
 - 1-1-7-2 Save messages
 - 1-1-7-3 Message lifetime
 - 1-1-7-4 MMS Settings

- 1-1-7-5 SMS Settings
- 1-2 Voicemail
 - 1-2-1 Get Voicemail
 - 1-2-2 Voice No.
- 1-3 Broadcast Msg
 - 1-3-1 Read info messag *
 - 1-3-2 Settings
- 2 Camera
 - 2-1 Digital Camera
 - 2-2 Album
- 3 Profile
 - 3-1 Normal
 - 3-1-1 Activate
 - 3-1-2 Personal Edit
 - 3-2 Meeting
 - 3-2-1 Activate
 - 3-2-2 Personal Edit
 - 3-3 Outdoor
 - 3-3-1 Activate
 - 3-3-2 Personal Edit
 - 3-4 Car
 - 3-4-1 Activate
 - 3-4-2 Personal Edit
 - 3-5 Silent
 - 3-5-1 Activate
 - 3-5-2 Personal Edit
- 4 Calls
 - 4-1 All Calls
 - 4-2 Missed Calls
 - 4-3 Received Calls
 - 4-4 Dialed Calls

- 4-5 Call Timers
- 4-6 Call Costs
- 4-7 GPRS info
 - 4-7-1 Last Connection
 - 4-7-2 All Connections
 - 4-7-3 Clear Logs
- 5 Movie Player
 - 5-1 Vidicon
 - 5-2 My Movie
- 6 Extras
 - 6-1 Alarm
 - 6-2 Calculator
 - 6-3 Clock Setting
 - 6-3-1 Auto Power On
 - 6-3-2 Auto Power Off
 - 6-3-3 Set Time
 - 6-3-4 Journey
 - 6-3-5 Set Time Zone
 - 6-4 STK
- 7 Settings
 - 7-1 Phone Settings
 - 7-1-1 Language
 - 7-1-2 Wallpaper
 - 7-1-3 Backlight Setting
 - 7-1-4 Owner Name
 - 7-1-5 Greeting
 - 7-1-6 Owner Number
 - 7-1-7 Keypad Guard
 - 7-1-8 Message Lock
 - 7-1-9 IP Setting
 - 7-1-10 Area Code

- 7-2 Call Settings
 - 7-2-1 Any Key Answer
 - 7-2-2 Auto Answer
 - 7-2-3 Call Waiting
 - 7-2-4 Minute Mind
- 7-3 Diverts
 - 7-3-1 All Calls
 - 7-3-2 When Busy
 - 7-3-3 No Answer
 - 7-3-4 Not reachable
 - 7-3-5 Cancel All
- 7-4 Network Settings
 - 8-4-1 Select Network
 - 8-4-2 Change Net Pwd
 - 8-4-3 Select Mode
- 7-5 Security Settings
 - 7-5-1 SIM Password
 - 7-5-2 Handset Lock
 - 7-5-3 Handset Call Bar
 - 7-5-4 Network Call Bar
 - 7-5-5 Fixed Dialing
- 7-6 Reset Settings
- 8 Playroom
 - 8-1 MP3
 - 8-2 Java
 - 8-3 File viewer
 - 8-4 Record
- 9 WWW
 - 9-1 Home
 - 9-2 Bookmarks
 - 9-3 Push

- 9-4 Settings
 - 9-4-1 Connection
 - 9-4-2 Cache Mode
 - 9-4-3 Push Security
- 9-5 Goto URL
- 9-6 Empty Temp Files
 - 9-6-1 Empty Cache
 - 9-6-2 Empty Cookies
 - 9-6-3 Empty Password

Note: The menu items with * can only appear under certain circumstances.

4.3 Names

You can use the phonebook function to save name card information such as names, groups, telephone numbers, personalized ring tones, pictures for incoming calls, QQ, email, and name card notes of important people. All you need to do is to press the **right soft key**, “**Names**”, directly enter the phonebook function.

Note: This mobile phone can save 500 telephone numbers. Different SIM cards store different amounts of numbers according to their memory size.

You can select any of the followings six functions in the phonebook: “**View names**”, “**Search**”, “**Add New Name**”, “**Delete All**”, “**Copy All**” or “**Settings**”.

- **“View names”**: quickly to view all of the entries recorded in the phonebook by the name.
- **“Search”**: To search for an entry in the phonebook by name. In the telephone number list mode, press the **Clear key** to return to the next higher menu.
- **“Add New Name”**: To add a new record to the phonebook. You can save the number in the **“SIM Card”** or the **“Phone Memory”**.
 - When you choose to save the new phone record in the **“Phone Memory”**:

You must fill in the name and a telephone number. Each entry can accept three numbers that can be set as **“Mobile”**, **“Home”**, **“Office”** or **“Fax”**.

You can set up a **“Group”**, **“Ring tone”**, **“Picture”**, **“QQ”**, **“Email”** or **“Notes”** for the newly created entry.

“Group”: You can enter the telephone numbers saved in the phonebook into different groups according to your relation to the people e.g.: **“No Group”**, **“Family”**, **“Friends”**, **“Colleague”**, **“Schoolmate”**, **“Society”** or **“VIP”**.

“Ring tone”: Set a personalized ring tone for the current phone entry. You can turn off or select

personalized ring tones from among the 20 built-in ring tones.

“**Picture**”: Set a personalized image for the current phone entry. You can select pictures from the “**Album**” submenu under the “**Camera**” to individualize your incoming call image.

“**Notes**”: Supplementary information to the current phone number entry.

➤ When you chose to save a new telephone entry into your “**SIM Card**” you must enter a name and telephone number. Each telephone entry can only accept one telephone number.

■ “**Delete All**”: to delete all the entries in the mobile phone or SIM card phonebook.

■ “**Copy All**”: to copy all the telephone entries on your SIM card onto your mobile phone, or to copy all the telephone entries on your mobile phone onto your SIM card.

Note: When you copy telephone number entries from your mobile phone onto your SIM card, only the names and telephone numbers will be copied.

■ “**Settings**”: You can select from the options: “**Filters**”, “**Save Nos. To**”, “**Used Space**”, “**Speed**

Dial List” and **Blacklist**”.

“**Filters**”:

You can set the desired entries to be displayed according to the groups of the check box marked with a tick when searching in the phone book using the “**View names**” or “**Search**” options.

“**Save Nos. To**”:

You can set a default setting for the storage of telephone numbers to be saved to “**SIM Card**”, “**Phone Memory**” or “**Choice**”. “**Choice**” allows the user to choose when adding a new phone entry.

“**Used Space**”:

You can view the total memory capacity and occupied memory space of the phonebooks for both the mobile phone and the SIM card.

“**Speed Dial List**”:

to view the one key dial settings of this phone. For example, if you associate a telephone number with the **Number key “2”**, then you can directly dial that number by holding down the **Number key “2”** on standby.

“**Blacklist**”:

you can look up and add blacklisted numbers. You can add at most 20 telephone numbers.

When a phone call from the “**Blacklist**” registry comes, you will not be notified of the call, but the phone number will be automatically entered into your “**Calls**”/“**Missed Calls**” call log for your reference.

In the phonebook, you can enter the list of phone book entries via “**View names**” or “**Search**” and use the **up/down key** to scroll to select a telephone number entry.

- Press the **left soft key**, “**View**”, to view the detailed data of the phone book entry that you have currently selected. You can view the information on name, group, telephone number, individualized incoming ring tone, and individualized incoming picture. If the information in the entry exceeds one screen length, you can use the **up/down key** to go to different lines, or press the **left/right key** to flip pages.

Note: If the currently selected telephone number entry is saved on the SIM card, then you can only view the name, location where the entry is saved, and telephone number in the entry.

Press the **Left soft key** “**Menu**” and you can carry out the following functions on the current telephone number entry: “**Edit**”, “**Add New**”

Name”, “**Messages**”, “**Delete**”, “**Copy Record**”, “**Add to speed**” and “**Add to blacklist**”.

Note: you can press the **dial key** to directly dial the selected telephone number in the list of the phonebook or in the detailed information interface mode of phonebook entry. If there are more than one telephone numbers in the entry, when you press the **dial key**, the list of numbers will appear. Select the desired number and then press the **dial key** again.

- You can carry out the following functions by pressing the **Function key**, “**Menu**”:

“**Search**”: to search for telephone number entries by name.

“**Edit**”: to edit the contents of the current telephone entry.

“**Add New Name**”: to add a new telephone entry into the phonebook to be saved either on the SIM card or mobile phone.

“**Messages**”: to create and send a SMS or MMS message to one of the phone numbers in the current phone entry.

“**Delete**”: to delete the currently selected telephone number entry.

“**Copy Record**”: to copy the currently selected telephone number entry to the mobile phone or SIM card.

“**Add to speed**”: to associate one of the phone numbers in the current telephone number entry with one of the number keys from 2 to 9. You can dial this number by holding down this key on standby.

“**Add to blacklist**”: to set one of the phone numbers in the currently selected telephone number entry as a blocked incoming number.

4.4 Message

Under the main menu standby, press Navigation Key to scroll to select “**Message**”, which includes the following options: **Message, Voicemail, and Broadcast Msg.**

Enter the “**Message**” submenu, the following options: “**New Message**”, “**Inbox**”, “**Outbox**”, “**Drafts**”, “**Sent**”, “**Archived**” and “**Settings**”.

Note: the options with “&” will only appear when the current message is MMS while the options with “*” will only appear when the current message is SMS.

4.4.1.1 New Message

Press **Left soft key "Select"** to create a new message.

If you select Message type as SMS:

- After finishing your SMS message you can press **left soft key "Options"** to select the **"Send to one"**, **"Send to many"** or **Send later**.
- Select the **"Send to one"** to edit the receiver's telephone number. You may enter the telephone number by yourself or select a number from your phone book entries after pressing the **left soft key "Done"**.
- Select the **"Send to many"** item to make following operation: **Add address** and **Send**. You may enter and add several telephone numbers from the phonebook via "add address" item. Select the "Send" item to send this SMS to these addresses together.
- Select **"Send later"** to save the message to Drafts.

If you select message type as MMS:

- After finishing your MMS message you can

press the **left soft key** “**Options**” to enter the edit options menu; press the **right soft key** and the user will be prompted either to save the current MMS for later sending, or to have it deleted. Here all saved MMS messages can be found in “**Drafts**”.

- The following are the choices of the edit options menu.

- “**Done**”: to finish editing the current MMS.

- “**Objects**”: to carry out the various operations

on the objects:

- “**Add picture**”: to insert a picture into the current page of the MMS from the USB disk of the mobile phone via the “**Load**” option or the photo taken by digital camera in your mobile phone via the “**Digital Camera**” option. This  icon at the top of the screen indicates that the current page contains a picture.

- “**Change picture**”: to change the current page’s picture.

- “**Add sound**”: to insert a sound into the current page from the USB disk of the

mobile phone. This [] icon at the top of the screen indicates that the current page contains a sound.

“Change sound”: to change the current page’s sound.

“Add attachment”: to insert a file into the current page from the USB disk of the mobile phone. This [] icon at the top of the screen indicates that the current page contains an attachment.

“Delete object”: to delete an object from the current page. After listing all the pictures/sounds/attachments of the current page in the MMS, select the object you wish to delete.

“Properties”: to control the timing of the objects in the current page, display the list of all the objects contained in the current page and permit modification of their properties, including **“Start time”** and **“Duration”**.

“Start time”: the start time of the

current page. The setting can be made from “0”, “1”, “2”, “4”, “8”, “16” seconds or “other”. “Other” allows the user to edit the start time.

“**Duration**”: the display time of the selected object can be set for “Maximum”, “1”, “2”, “4”, “8” or “16” seconds or “other”. “Maximum” indicates that the object will be displayed until the playing of the current page has ended. “Other” means that the user can edit the display time of the selected object.

- “**Pages**”: to carry out the various operations on the page in the MMS:

“**Add page**”: to insert a page at the end of the current MMS to make it into the current page.

“**Delete page**”: to delete the current page to make its previous page into the current page. If the deleted page is the first page? then the next page will become the current page.

“**Page layout**”: to control whether the

2B575C2picture or text is displayed at the top.

“Page duration”: to control the display time of the current page. It can be set for “Marimum”, “1”, “2”, “4”, “8”, “16” seconds, or “Other”. “Other” allows the user to define the period.

“Position”: to copy the current page into its next page, previous page, first page or last page.

“Page up”: to turn to the previous page from the current page.

“Page down”: to turn to the next page from the current page.

- **“Preview”**: to preview the current MMS.

Note: Some of the options above only appear under certain circumstances, for example, **“Delete page”** only appears when the current MMS exceeds one page. The Each page of a MMS can only contain one picture and one sound. When the current page contains a sound or picture, **“Add picture”** will change to **“change picture”** or **“Add sound”** will change to **“change sound”**. When editing an MMS, the status information line bar at

the top of the screen will display the following: whether the current page contains a picture, a sound and attachment; the entire size of the MMS in units of 1KB; the current page/total pages; and the input mode.

- Select “**Done**” from the edit options menu to complete editing of the current MMS and enter the subject/address option menu:
 - “**Send**”: to send the current MMS. The progress line indicates the progress of the sending operation.
 - “**Send later**”: to not send the current MMS and automatically save it into “**Drafts**”.
 - “**Subject**”: to enter the subject of the contents of the current MMS.
 - “**To**”: to enter the recipient’s phone numbers or select them from the phonebook to send the current MMS to the other party’s mobile phone. You can also enter the recipient’s E-mail address and send the E-mail to the other party’s electronic mailbox.
 - “**CC**”: to send a copy of the current MMS to a third party.
 - “**BCC**”: to secretly send a copy of the current

MMS to a third party.

- **“Priority”**: to set the priority of the current MMS. This includes **“Normal”**, **“High”** and **“Low”**.

4.4.1.2 Received Msg

When you receive a new message, generally your mobile phone will vibrate (if the **“Vibrator”** is set to **“On”**) or ring (if the **“Message Alert”** function is on. At this time the **“New events”** and the number of message will be displayed on the screen.

Press the **right soft key** not to read the message

Press the **left soft key**, to access **“Inbox”**.

4.4.1.3 Inbox

Recently received messages including SMS and MMS are saved in **“Inbox”** folder.

Access **“Inbox”** submenu. Your mobile phone will display a list of the messages in the **“Inbox”**. Press the **up/down keys** to scroll to the message you want to read. By pressing the **left soft key**, **“Options”**, you can carry out the following operations on the current message:

- **“Open”**: to browse the contents of the current

message. Press the **left soft key**, "**Options**", to carry out the following functions on the current message: "**Delete**", "**Reply**", "**Forward**", "**call sender**", "**Archive**", "**Extract numbers**", & "**Objects**" and & "**Details**".

"**Reply**" is to send a short message to the sender of the current message.

"**Call sender**": to call the sender of current message.

"**Save number**" is to save the sender's phone number to the phonebook.

"**Archive**": to save the current message to "**Archive**" folder.

"**Extract numbers**": to extract the numbers in content of MMS and save them to phonebook.

&"**Objects**" is to extract the individual objects (such as picture and sound) in the current MMS and carry out the "**Save**" operation. Pictures, sounds and attachment are saved into Usb disk in your mobile phone.

&"**details**" is to view detailed information of the current MMS such as "**Subject**",

“Date”, “From”, “To”, “CC”, “BCC”,
“Priority”, “Receipts”, “Message class”,
“Size” and “Lifetime”.

- **“Edit”**: to edit and send the current message. If the message is SMS, select ***“Send to one”** or ***“Send to many”**. If the message is MMS, select &**“Done”**, &**“Objects”**, &**“Pages”** and &**“Preview”**.

***“Send to one”** is to edit and send the current SMS to one person.

***“Send to many”** is to edit and send the current SMS to several persons.

&**“Done”** is to finish editing the current MMS and enter the subject/address option menu.

&**“Objects”** is to perform the relative operation on the Objects.

&**“Pages”** is to perform the relative operation on page.

&**“Preview”** is to preview the current MMS.

- **“Forward”**: to forward the current message to other person. If the message is SMS, select ***“Send to one”** or ***“Send to many”**. If the message is MMS, enter the subject/address option menu.

- **“Delete”**: to delete the current message.

- ***“Store on SIM”**: to save the current SMS from

mobile phone into SIM card.

- ***“Store on handset”**: to save the current SMS from SIM card into mobile phone.
- **“Delete all”**: to delete all the messages in the **“Inbox”** folders.

4.4.1.4 Outbox

Unsuccessfully sent messages (including the SMS and MMS) are saved in the **“Outbox”** folder.

Accessing **“Outbox”** submenu, your mobile phone will display a list of the messages. Press **up/down keys** to scroll to the message you want to read. By pressing the **left soft key, “Options”**, you can carry out the following operations on the current message:

- **“Open”**: to browse the contents of the current message. Press the **left soft key, “Options”**, to carry out the following functions on the current message: **“Edit”**, **“Delete”**, **“Archive”**, &**“Objects”** and &**“Details”**.

- **“Edit”**: to edit and send the current message. If the message is SMS, select ***“Send to one”** or ***“Send to many”**. If the message is MMS, select &**“Done”**, &**“Objects”**, &**“Pages”** and &**“Preview”**.

- **“Send”**: to send the current message.
- **“Delete”**: to delete the current message.

- &“**Details**” is to view detailed information of the current MMS.
- “**Delete all**”: to delete all the messages in the “**Outbox**” folders.

4.4.1.5 Drafts

Drafts save unfinished messages which can be revised and send later.

Accessing “**Drafts**” submenu, your mobile phone will display a list of the message. Press **up /down keys** to scroll to the message you want to read. By pressing **left soft key**, “**Options**”, you can carry out the following operations on the current message:

- “**Open**”: to browse the contents of the current message. Press the **left soft key**, “**Options**”, to carry out the following functions on the current message: “**Edit**”, “**Delete**”, “**Archive**” and &“**Details**”.
- “**Edit**”: to edit and send the current message. If the message is SMS, select ***Send to one**” or ***Send to many**”. If the message is MMS, select &“**Done**”, &“**Objects**”, &“**Pages**” and &“**Preview**”.
- “**Send**”: to send the current message.
- “**Delete**”: to delete the current message.

- &“**details**” is to view detailed information of the current MMS.
- “**Delete all**”: to delete all the messages in the “**Drafts**” folders.

4.4.1.6 Sent

All successfully sent messages are stored in “**Sent**” folder

Accessing “**Sent**” submenu, your mobile phone will display a list of the message in “**Sent**” folder. Press **up/down keys** to scroll to the message you want to read. By pressing **left soft key**, “**Options**”, you can carry out the following operations on the current message:

- “**Open**”: to browse the contents of the current message. Press the **left soft key**, “**Options**”, to carry out the following functions on the current message: “**Edit**”, “**Delete**”, “**Forward**”, “**Archive**”, &“**Objects**” and &“**Details**”.

- “**Edit**”: to edit and send the current message. If the message is SMS, select ***Send to one**” or ***Send to many**”,. If the message is MMS, select &“**Done**”, &“**Objects**”, &“**Pages**” and &“**Preview**”.

- “**Delete**”: to delete the current message.

- & “**Details**” is to view detailed information of the current MMS.
- “**Delete all**”: to delete all the messages in the “**Sent**” folders.

4.4.1.7 Archived

“**Archived**” stores the messages moved from other folders such as “**Inbox**”, “**Outbox**”, “**Drafts**” and “**Sent**”.

Accessing “**Archived**” submenu, your phone will display a list of the messages in “**Archived**”. Press **up/down keys** to scroll to the message you want to read. By pressing the **left soft key**, “**Options**”, you can carry out the same operations on the current message as it is in previous folder.

4.4.1.8 Settings

You must make necessary settings before you use SMS and MMS functions.

Accessing the “**Settings**” submenu, you can select the following options:

- “**Default message**” is to set the default message type as: “**Always MMS**”, “**Always SMS**” or “**Prompt**”. Selecting “**Prompt**”, the

device will prompt user about message type before creating a message.

- **“Save messages”** is to set whether it is saved into the **“Sent”** folder after the message is sent successfully.
- **“Message lifetime”**: to set the lifetime of the message at the message service centre (this time is related to the service provided by your network operator).
- **“MMS Settings”** is to perform the following settings on MMS:
 - “Message center”**: to set MMS center address e.g. <http://mmsc.monternet.com>. For more detailed information, Please contact your network operator.
 - “WAP profile”**: to select profile files for wap application.
 - “Read reports”**: Whether request a read report about MMS receiving status, such as **“Send report”** and **“Request report”**.
 - “Deliver receipts”**: Whether show the sending status of MMS.
 - “Download (home)”**: set the download mode of MMS when a MMS is received in your

home zone, e.g. **Automatic** and **Prompt**.

“**Automatic**” means the MMS will be automatically downloaded to your mobile phone when it has been received. The user will not be notified until it has been completely downloaded.

“**Prompt**” means the user will be notified when there is a MMS; user can read it by selecting the MMS and download it.

“**Download (roaming)**”: to set download mode of MMS when a MMS is received in roaming mode, e.g. **Automatic** and **Prompt**.

“**Spam filter**”: to set if your mobile phone’s Spam filter should be activated. This includes “**Off**”, “**Prompt if spam**” and “**Reject spam**”.

“**Spam**” refers to the MMS that has been marked as “spam”.

“**Off**”: all MMS should be accepted.

“**Prompt if spam**”: prompts whether to download spam.

“**Reject spam**”: reject the spam directly without notice user.

“**Creation Mode**”: set the mode when a MMS is created. This includes “**Restricted**”, “**Give**”

Warnings” and **Free**”.

“Restricted”: only the object that compatible with MMS standard format object can be inserted.

“Give Warnings”: warn the user while incompatible object is inserted.

“Free”: any object may be inserted into the MMS.

“Max Message Size”: to set the maximum size of a MMS as 30kB, 60KB, or 100KB.

- **“SMS Settings”** is to perform the following setting on SMS:

“Message centre”: to set SMS centre number. For more detailed information, Please contact your network operator.

“Status Report”: If you set it as **“On”**, when the recipient receives your short message, or if the short message is not received for some reason, the message centre will send a status report so that you can see whether the message has been delivered.

“Save Position”: If you set it as **“Sim card first”**, the received SMS will be saved to SIM card

firstly, otherwise it will be saved to phone memory firstly.

“Capacity Status”: Here you can view the total memory capacity and occupied memory space of messages on both the mobile phone and the SIM card. You can save up to 200 messages to your mobile phone (including received messages in **“Received Msg”** and messages saved in **“Sent Message”**). The number of messages saved on the SIM Card is determined by the size of the SIM Card. If both your mobile phone and SIM card are full, the icon area will display a flashing icon.

4.4.2 Voicemail

When you can't answer an incoming call, it will be automatically diverted to voicemail centre, so that the caller can leave a message on voicemail system of service network; then you can access the voicemail system to listen.

- Access **“Voicemail”** submenu where you can see two options: **“Get Voicemail”** and **“Voice No.”**.
- By selecting **“Get Voicemail”** you can call the

voice mailbox number stored in the “**Voice No.**” submenu.

- You can enter and edit your voice mailbox number through the “**Voice No.**” and by pressing the **left soft key “OK”** to save the number.

Note: Voice Mail Server need the support of network operator, you may apply for the service. For more information or mail box address you can consult local network operator.

4.4.3 Broadcast Msg

Broadcast messages refer to public messages sent by your network operator. If you use the broadcast message service you can receive messages on all different subjects from your network operator such as: the weather, taxis, hospitals, etc. Please contact your network operator for available subjects.

- Accessing “**Broadcast Msg**” submenu you will see two menu options: “**Read info msg**” and “**Settings**”.
- You can select the “**Language**” and “**Subject**” of messages you are interested by selecting options in the “**Setting**” menu.
- You can set usable message subject by **Subject/ Current List**. Meanwhile, you can also create new subject by Selecting **Subject/ Create subject**.
- After making the necessary settings, when there are incoming broadcast messages, you can read the message subjects that have been set using the “**Read messages**” option from the menu. If the Subject’s “**Current List**” option is empty, then the “**Read messages**” menu will be hidden. Please fill in the “**Current List**” option with the required subject (including subjects created by the user) in order to display the “**Read messages**” option. You can enter a maximum of two message subjects. And you can of course delete message subjects that have been set from the “**Current List**” option.

Note: Broadcast Message need the support of network operator.

4.5 ZTC Paradise

Under the main menu, press **the Navigation Key** scroll to select “ZTC Paradise” main menu. You can enjoy the enhanced service that we provide to you. Those services may be charged extra fee from you, please see some charge instruction and product introduction or inquire the retail saler before using such services.

4.6 WWW

Your mobile phone supports wireless application protocol (WAP) service. You can access many different WAP services such as news, weather reports, flight information, and others. These services are especially designed for mobile phones and maintained by WAP service providers.

Network support is necessary for WAP services. Please contact your network provider and/or the service provider of the desired service. The service provider will also provide instructions about how to use their service.

In the main menu interface, press the **navigation**

keys to scroll to “**WWW**”. Here you will see the following menu options: “**Home**”, “**Bookmarks**”, “**Push**”, “**Settings**”, “**Goto URL**” and “**Empty Temp files**”.

4.6.1 Home

Select the “**Home**” to enter the home page. The Home page is the WAP site set by you in the activated connection mode. If you have not set a page, then the site will be the default homepage set by the manufacturer.

E.g: <http://wap.monternet.com>。

4.6.2 Bookmarks

Select “**Bookmarks**” to display the various bookmarks contained in the bookmark list. Use the **up/down keys** to select the desired bookmark, press the **left soft key**, “**SELECT**”, to carry out “**Select**”, “**Edit name**”, “**Edit address**” and “**Delete**” operations. If you select “**Select**”, you can be directly connected with the website designated by the bookmark.

Note: Before use please confirm that your bookmark list is not empty. Refer to the introduction in section **4.12.7, How to Use Online Functions**, on how to add bookmarks to the list.

4.6.3 Push

Select “**Push**” to view received service messages.

Your mobile phone can receive service messages sent by your service provider. For example, service messages may consist of notifications on news briefings, or a line of a text message, or a WAP service address.

4.6.4 Settings

Select “**Settings**” to enter settings for online browsing, including “**Connection**”, “**Cache Mode**” and “**Push Security**”.

4.6.4.1 Connection

1. You may select one of the two default connection methods for WAP service according to your needs. If you need to access the WAP services provided by the other network operator, you must edit one of the two default connection methods or add a new connection method with “**Add New**” according to the setting values designated by your network operator. For more information, please consult with your network operator.

Note: Before using WAP, you must select and activate the connection method of the WAP service.

2. Press the **left soft key “SELECT”** to carry out **“Activate”**, **“Edit”**, **“Rename”** or **“Delete”** on your selected connection method.

3. You can **“Edit”** the following aspects of your selected connection method:

- **“Homepage”**: to enter the web address (URL) you wish to use as your home page.

- **“Display images”**: to set whether to activate the display image functions.

- **“Connect Type”**: to set as either **“Temporary”** or **“Continuous”** depending on the gateway.

- **“Secure Setting”**: to set connection security. It can be set as **“None”** or **“Secure”** depending on the gateway.

- **“Bearer”**: to set the carrier method as **“Data”** or **“GPRS”**. We do not recommend the data method.

- **“Data Settings”**: if the **“Bearer”** is set as **“Data”** then the next neighbouring menu to **“Bearer”** is **“Data Settings”**. Press the **left soft key “SELECT”** to enter the following settings (the values for the settings are provided by the network. Before using, please confirm with your network operator that **“Data”** service has

been activated for you.):

“IP address”: to enter the IP address of the WAP gateway you are accessing.

“Dial number”: to enter the dial-up number of the WAP gateway you are accessing.

“Data call type”: to set the type of data call as “Analog” or “ISDN”.

“Data call speed”: The data connection speed can be set as 2400, 4800, 9600 or 14400.

“User ID”: to set the user ID of the dial-up server (not the WAP gateway).

“Password”: to set the password needed by the dial-up server (not the WAP gateway) to recognize your identity.

“Timeout”: You can set a time limit. If there is no data entered or transferred beyond this time limit the service will automatically turn off. The timeout period may be set for “30 secs”, “60 secs” or “120 secs”.

“GPRS Settings”: if the **“Bearer”** is set as **“GPRS”** then the next neighbouring menu to **“Bearer”** is **“GPRS Settings”**. Press the **left soft key “SELECT”** to enter the following settings (**GPRS** service requires network support. Before using, please confirm with your

network operator that **GPRS** service has been activated for you and that your mobile phone is located in an area covered by the **GPRS** network. At such a time, a “**G**” will appear on the right side of the network signal strength bar.):

“**IP Address**”: Enter the IP address of the WAP gateway you are accessing.

“**APN**”: Enter the APN (Access Point Name).

“**User ID**”: The user ID of the APN server.

“**Password**”: The password needed by the APN server to recognize your identity.

4.6.4.2 Cache Mode

The cache mode can be set for “**Always Check**” or “**Never Check**”.

4.6.4.3 Push Security

The security level of the “Push” service mailbox may be set for “**Accept All**”, “**Trusted Only**” or “**Accept None**”.

4.6.5 Goto URL

Select “**Goto URL**” to enter the URL address of the WAP service you need to access. Then press the **left soft key** to confirm to connect to the desired WAP

site.

Note: You do not need to attach the prefix “**http://**” to the address as it will be automatically added.

4.6.6 Empty Temp files

Data or services that you have visited will be saved in the cache memory of your mobile phone. Please promptly clear these temporary files which record your online data.

Select “**Empty Temp files**”, to carry out the following operations:

- “**Empty cache**”: To clear information on the most recently visited sites stored in your mobile phone’s cache memory.
- “**Empty Cookies**”: To clear login information stored in your mobile phone’s cache memory.
- “**Empty Password**”: To clear login passwords stored in your mobile phone’s cache memory.

Note: If you tried to visit, or successfully visited confidential information that required a password (such as a bank account), please clear your mobile phone’s cache memory each time.

4.6.7 How to Use Online Functions

By pressing the **right soft key**, “**OPTIONS**” when browsing WAP service pages, you may carry out the following operations:

“**Refresh**”: to download the current page again.

“**Home**”: to return to the WAP service home page.

“**Back**”: to return to the previous page.

“**Bookmarks**”: to display all your saved bookmarks. Press the **left soft key**, “**SELECT**”, to directly go to the bookmark’s site, edit the bookmark’s name, edit the bookmark’s address, or delete the bookmark.

“**Add Bookmark**”: to create a new bookmark for the current page. Your mobile phone will prompt you to create a bookmark name and save the address to your bookmark list.

“**Goto URL**”: you can go directly to a desired site by directly entering the specific URL address.

“**Quit WAP**”: to exit the WAP browser window and disconnect.

“**Save Image**”: select this operation to save a picture. This option will only appear when there is

a picture in the current page.

“**Special Options**”: to carry out special options. This option will only appear when there are hidden options on the current page.

Note: Under any circumstances while browsing a WAP page, by pressing the **end key**, you may exit the WAP browser window, disconnect and return to the standby mode.

4.6.8 Explanation of the Mobile Phone Keys in the Browser

Press the **up/down keys** to scroll through the WAP page.

Press the **Function key** to select highlighted content.

Press the **number keys** from **1** to **9** to enter letters and numbers.

Press the *** key** to enter special symbols.

Press the **Number key “1”** to enter punctuation marks under the number, uppercase and lowercase input mode.

Press the **right soft key, “OPTIONS”**, to enter the online function’s options.

Note: The function of your mobile phone’s keys may

differ with WAP services. Please follow the prompting text on the screen of your mobile phone. For more information please contact your WAP service provider.

4.7 Calls

In the main menu interface, press the **navigation keys** to scroll to “**Calls**”. Here you can look up information on the call records. These include the “**All Calls**”, “**Missed Calls**”, “**Received Calls**”, “**Dialed Calls**”, “**Call Timers**”, “**Call Costs**” and “**GPRS Info**” options.

4.7.1 View Call Log

Your phone can store 20 of the most recently missed calls, received calls and made calls respectively. These records can be viewed with the corresponding menu of your phone.

- Enter the “**All calls**” submenu to view the all call log list.
- Enter the “**Missed Calls**” submenu to view the missed call log list.
- Enter the “**Received Calls**” submenu to view the received call log list.
- Enter the “**Dialed Calls**” submenu to view the dialled call log list.

Use the **up/down keys** to select an entry in the selected call log list.

- Press the **left soft key** “**View**” to view the details of the currently selected call record such as the other party’s name, telephone number, date, time the call ended, number of call, and period of the call. Press the **left soft key** “**call**” to call the telephone number of the current call log.
- Press the **Function key**, “**Menu**”, to carry out the following:
 - “**Delete**”: to delete the currently selected call record.
 - “**Delete all**”: to delete all the records in the currently selected call log list.
 - “**Detail**”: to view the detailed information (including the name of the other party, phone number, date, time call ended, number of calls, period of call) of the current call.
 - “**Save**”: to save the current call log to your “**SIM card**” or “**Phone Memory**”.
 - “**Add to blacklist**”: to add this number to your incoming blacklist.

- **“Message”**: to send a SMS or MMS to the current number.

Note: Having entered the call log list, or the call details interface of the call log, at the top right of the screen will be displayed the location of the present call log and the total number of entries in this call log list. By pressing the **Calling key**, you can directly call the phone number of the current call record.

All the call entries in the call log are displayed in chronological order. When there is no more space in one of the call log lists, your mobile phone will automatically delete the earliest call records, saving the most recent call record.

4.7.2 Call Timers

Enter the **“Call Timers”** submenu to view last call time as well as respective accumulated call time of received calls, dialled calls and all calls.

4.7.3 Call Costs

Enter the **“Call Costs”** submenu to view or set the **“Last Call”**, **“All Call Info”**, **“Clear logs”**, **“Cost Units”**, **“Max Cost”** options.

- **“Last Call”**: to view the cost of the last call.

- **“All Call Info”**: to view the accumulated cost of all calls.

- **“Clear logs”**: to clear the call cost log record after entering the PIN2.

- **“Cost Units”**: to view and set the call cost unit by the two options: **“Read Units”** and **“Set Units”**.

- **“Max Cost”**: to view and set the limit on call cost by the two options: **“Read Units”** and **“Set Units”**.

Note: to be used, your network operator must support the **“Call Costs”** function. You need to enter your PIN2 number to set the **“Cost Units”** and **“Max Cost”**. Please contact your network provider to obtain this number.

4.7.4GPRS Info

Enter the **“GPRS Info”** submenu to view the quantity of data flow transmitted on the network via GPRS. This includes sent, received or total data flow quantity. You can also reset it to zero. You can select from the following options:

“Last Connection”: to view the quantity of data flow of the last connection.

“All Connections”: to view the quantity of data flow of all connections.

“**Clear Logs**”: to clear the data flow quantity record.

4.8 Movie player

Your mobile phone supports vidicon function.

In the main menu interface Press the **navigation keys** to scroll to “**Movie player**”. It includes two options: “**Vidicon**” and “**My Movie**”.

4.8.1 Vidicon

Select “**Vidicon**” submenu, Press **Left Soft Key** to enter shooting status

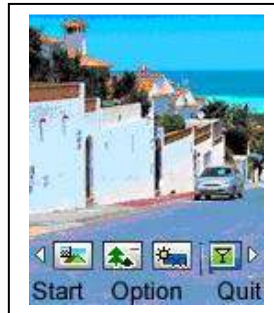



4.8.1.1 Vidicon Setting





Under taking pictures standby, vidicon setting shows on the upper of the **Soft Key Icon**, each shooting option standby will be indicated by an icon. See []. Press **Left**



/Right Key to switch between **Setting options** in vidicon.
Press Up/Down Key to adjust the selected option.

Note: Press ***Key** to hide /display the vidicon setting option.

- **Image effect:** to set the colour style of the movies taken. These include: **“Normal”** [], **“Black&White”** [], **“Sepia”** [], **“Inverse”** [], **Oil** [] , **Enbossment**[]、 **Jean** []、 **Copper Carve**[]、 **Sketch**[]、 **Crayon**[] .

- - **Zoom:** To adjust the focus of the vidicon.
The default setting is for normal [].
Press the **down key** [] to move the focus in, and press the **up key** to increase the focal distance [].

- **Lightness:** to adjust the brightness of the movie.
There are 5 levels in total [] [] [] [] [], the higher the level, the brighter the picture.

- **Rotation:** to adjust the angle of the vidicon’s viewfinder. This includes **Off** [] and **180°** [].

4.8.1.2 Shooting

- After framing the picture you wish to take, keep the vidicon steady. Press the **left soft key “Start”** to take a movie instantly or press the **right soft key, “Option”** to carry out the **“Image effect”, “Auto save”, “Storage”** and **“Picture Size”** settings.
 - “Auto Save”**: to set whether the movie taken is automatically saved with a default file name.
 - “Storage”**: to set the storage position of the movie taken as the **“Phone”** or **“Memory card”**.

- During taking a movie, press the **left soft key “Stop”** to stop kinescoping.
- Press the **left soft key, “Ok”**, to save the current movie. Or press the **right soft key** to quit saving. The default filename which the movie will be saved under is the mobile phone time when the movie was taken (month/day/hour/min/sec). You can also edit the file name and press the **left soft key** to confirm. After the movie is saved to the **“My Movie”** submenu of the **“Movie player”**, you

will be returned to the view-finding mode;

- Note:** 1. you can view my recorded vidicon in directory of [Movie Player]/[My Movie]
2. You can also view the my recorded movie in “FILM” directory of [Extras]/[Playroom]/[WWW]

4.8.2 My movie

“**My Movie**” can store and play the movies taken with your vidicon.

Enter the “**My Movie**” submenu to open the movie player. You may play the movie which is saved in the “**FILM**” submenu under “file viewer”.

Press **Function key** to start playing the movie marked with a tick in the MP4 list or make a pause.

Press **Down key** to stop playing the current music.

Press **Left key** to play previous movie marked with a tick in the MP4 list.

Press **Right key** to play next movie marked with a tick in the MP4 list.

Press **Up key** “list” to enter the MP4 list, press **Up/down keys** to scroll to the desired movie in list, press **left soft key** to mark this movie with a tick or remove this movie from marked list. You may press **Function key** to select “**Select all**” quickly to make all

the music with a tick in MP3 list, or select "**Cancel all**" to remove all the music from the selected list, or Set the storage location as the "Phone" or "Memory card" to view the movie in MP4 list.

Press **End key** or **right soft key** to close the movie player.

Note:

The mobile phone supports the target files of movie player as follows:

- A. support the extension is mp4、 3gp files.
- B. Video: code format is mpeg4、 h263。
- C. Video size: QCIF(176*144)。
- D. Audio: AMR、 AAC。
- E. Frame number is <=30fps

4.9 Profile

Your mobile phone provides many different profiles for you to set your mobile phone's ring tone, according to case and environments.

In the main menu interface, press the **navigation keys** to scroll to "**Profile**" where you will be able to see the following options:

- "**Normal**": for use under normal circumstances.
- "**Meeting**": for use in meetings. This requires

presetting (for example, the “**Vibrator**” can be set to “**On**”).

- “**Outdoor**”: for use in outdoor activities. This requires presetting (for example, you can set the volume of the receiver and ring tone higher).

- “**Car**”: for use in the interior of an automobile. This requires presetting (for example, you can set the receiver volume higher).

- “**Silent**”: for use in quiet environments. This requires presetting (for example, you can set the “**Vibrator**” to “**Off**” and the ring tone volume to zero).

After you have selected one of the above five profiles, you may carry out the following operations:

- **Activate**: to start up the selected profile.

- **Personal Edit**: to modify setting options of the selected profiles. These include: “**Ringtone Type**”, “**Ringtone Volume**”, “**Speaker Volume**”, “**Vibrator**”, “**Keypad Tone**”, “**Warn Tone**”, “**Message Alert**”, and “**On/Off Ring**”. The settings options are the same as for “**Audio**” in section 4.7.

- **Ring Type**: to set the ring tone of incoming call. You can turn off the ring, or select from the 20 built-in chord ring tones.

“**Ring Volume**”: to set the ring tone volume.

When the “**Ring Volume**” is set to zero, there will be a mute icon [] displayed in the icon area of the standby interface.

“**Speaker Volume**”: to adjust the volume of the receiver.

“**Vibrator**”: to turn on or off the vibrator. When the “**Vibrator**” is set to “**On**”, a vibrate icon [] will be displayed in the icon area of the standby interface.

“**Keypad tone**”: to turn on or off the keypad tone when a keypad is pressed.

“**Warn Tone**”: to turn on or off the warn tone.

“**Message Alert**”: to select or turn off the message alert.

“**On/Off Ring**”: to select or turn off the power on/off ring.

Note: These five profiles have already been set and the default profile is “Normal” when the mobile phone leaves the factory.

4.10 Settings

In the main menu interface, press the **navigation**

keys to scroll to “**Settings**”. In this menu you can make settings that configure your usage preferences for your mobile phone. These include “**Phone Settings**”, “**Call Settings**”, “**Diverts**”, “**Network Settings**”, “**Security Settings**” and “**Reset Settings**”.

4.10.1 Phone Settings

Enter the “**Phone Settings**” submenu. Here you can make the following settings.

- “**Language**”: to set the current language type as “**简体中文**” or “**English**”.
- “**Wallpaper**”: Press the **navigation keys** to scroll to an internally available picture, and press the **left soft key** to confirm.
- “**Backlight Setting**”: to Set the duration of backlight after it is lighten.
- “**Owner Name**”: to set the name of the owner of the phone.
- “**Greeting**”: to set the startup greeting for the phone.
- “**Owner Number**”: to edit or view your mobile phone number.
- **Keypad Guard**: On or Off the Keypad Guard function. when the keypad set as On, it will

knocked automatically if there is no operation to the handset within certain time. Press **Right Soft Key** and **Left Soft Key** ordinarily to unknock the keypad.

-**Message Lock** Enter the correct phone code to “**On or Off**” the message lock function. If the **Message Lock** is set as **On**, correct code must be inputted to enter the **Message** submenu.

-**IP Setting**”: Press **Left Soft Key** to **Select**, enter **IP Connection Setting**, “Here you can make the following settings:

“**IP Number**”: to edit the IP connection number.

“**Function Switch**”: to turn on or turn off use of the IP connection number. If you turn on the IP function switch, then press and hold the **Number key “1”** on standby, the IP connection number will automatically be entered.

- “**Area Code**”: Press **Left Soft Key** to **Select** and enter **Area Code** Setting. Here you can make the following settings:

“**Area Code**”: to edit the area code.

“Function Switch”: to turn on or turn off the use of an area code. If you turn on the area code function switch, then press and hold the **Number key “0”** on standby, the area code will automatically be entered.

4.10.2 Call settings

Enter the **“Call Settings”** submenu. Here you can make the following settings:

- **“Any Key Answer”**: select **“On”** and you can pick up an incoming call by pressing any key other than the **end key, right soft key** and the **side keystroke**; select **“Off”** and you can only pick up using Calling key and **left soft key**.

- **“Auto Answer”**: select **“On”** to turn on the auto -answer function; select **“Off”** to turn off the auto-answer function. The auto answer function may only be used when the earphones have been plugged in.

- **“Call Waiting”**: select **“On”** to activate this function; select **“Off”** to cancel this function; select **“Status”** to view the status of this function. After activating this function, the network will notify you

that you have a new incoming call when you are talking on the phone. For details of how to use this function you can contact your network provider.

- **“Minute Mind”**: select **“On”** to activate the minute reminding function; select **“Off”** to turn off the minute reminding function.

4.10.3 Diverts

The call diversion network service permits you to divert, under certain preset situations, certain incoming calls to a telephone number designated by you. This service requires network support. Please contact your network provider to activate this service. You can set and cancel the incoming call diversion function of your mobile phone.

4.10.3.1 Diverting Settings

Enter the **“Diverts”** submenu. You can set calls to be diverted to a preset number under the following four circumstances:

- **“All calls”**: to divert calls under all circumstances.
- **“When busy”**: to divert when the mobile phone is engaged.
- **“No answer”**: to divert when there is no answer.

- **“Not reachable”**: to divert when the phone is off or not in the network area.

When you have selected one of the above four modes, you may carry out the following operations:

- **“On”**: Only after registering may you use the diversion service. Enter the phone number you wish to divert to after selecting **“On”**.

- **“Off”**: to cancel the diversion service.

- **“Status”**: to view if this service has already been registered.

Note: If you have set your mobile phone to the **“All Calls”** function, the top line of the standby interface display will show a  icon.

4.10.3.2 Cancel All Diverting

Enter the **“Diverts”** submenu. Press the **up/down keys** to select **“Cancel all”** and you can cancel all the diversion services registered.

4.10.4 Network Settings

Network settings are dependent on your network provider. Please contact your network provider when using this function. When you are roaming abroad, you must select a network, and

connect your mobile phone with a foreign GSM/GPRS network. Usually you can select the automatic mode (default mode), but you can also have your mobile phone manually search for an available network, or request to search for a network again. If you wish to join a network that has no agreement with your original network provider, your mobile phone will display “**Network Bar**”.

Enter the “**Network Settings**” submenu. You can make the following settings: “**Select Network**” and “**Change Net Password**”.

4.10.4.1 Select Network

Enter the “**Select Network**” submenu. Here you can make the following settings:

Select “**Automatic**” to automatically search for the network provider;

Select “**Manual**” to manually search and select the network provider.

4.10.4.2 Change Net Password

The network provider provides you with a 4 digit **Net Password** to allow you to activate the “**Network**”

Call Bar” service.

Enter the “**Change Net Pwd**” submenu. Here you can change your Net Password. When you use this function, please contact your network provider.

4.10.5 Security Settings

Enter the “**Security Settings**” submenu. Here you can set the security options of your mobile phone to avoid the illegal use of your mobile phone and SIM card.

Note: You must use the correct handset lock code to enter the security setting submenu.

4.10.5.1 SIM password

The PIN number can prevent the illegal use of your SIM card. Enter the “**SIM Password**” submenu. Here you can make the following settings:

- If your PIN number protection is currently inactive, select “**ON**” to activate the PIN number protection. The next time you turn on your phone you will be asked for your PIN number;
- If your PIN number protection is currently in use, select “**Off**” to turn off the PIN number protection, or select “**Change PIN**” to set a new PIN number.

Please enter your old PIN number, new PIN number and re-enter your new PIN number in this order, according to the prompts.

Note: If you successively enter your PIN number three times incorrectly, your SIM card will be locked. At this time you need the PUK number to unlock the SIM card. The PIN number and PUK number may have been provided to you together with the SIM card. If you do not have it, please contact your network provider. The default PIN number is usually 1234.

4.10.5.2 Handset Lock

The Handset lock can prevent the unauthorized use of your mobile phone.

Enter the “**Handset Lock**” submenu. Here you can make the following settings:

- If your Handset lock protection is currently inactive, select “**On**” to activate the handset lock protection. The next time you turn on your phone you will be asked for your handset lock code;
- If your handset lock protection is currently in use, select “**Off**” to turn off the handset lock protection;
- Or select “**Change Code**” to set a new handset

lock code. Please enter your old code, new code and re-enter your new code in this order, according to the prompts.

Note: The default handset lock code is 1234. You should change it to your own code as soon as possible.

4.10.5.3 Handset Call Bar

Enter the “**Handset Call Bar**” submenu. You can make the following settings:

- “**Bar Incoming**”: select “**On**” to bar all incoming calls; select “**Off**” to cancel the incoming call bar function.

- “**Bar Outgoing**”: select “**Bar All**” to bar all outgoing calls other than emergency calls; select “**List**” to bar all calls on the barred call list in addition to all calls whose numbers have the same initial numbers as those on the barred call list; select “**Off**” to cancel the outgoing call bar function.

4.10.5.4 Network Call Bar

You can set any of the following call bar groups to increase security. Some network providers may not be able to provide Network Call Bar service. For details

please contact your network provider. Your network provider will provide you with a 4 digit **Net Password** to permit you to use the Network Call Bar service.

- Enter the “**NetworkCall Bar**” submenu. Here you can set the following outgoing or incoming call bar types:
 - “**Out.International**”
 - “**Out.intl.exHome**”
 - “**All Incoming**”
 - “**In.when.Roaming**”
 - “**All Outgoing**”
- After you enter one of the above five options, press the **up/down keys** to select one of the options below to set which service you wish to bar:
 - “**All Service**”: to bar incoming calls, voice calls and short messages, etc.
 - “**Voice Call**”: to only bar voice calls.
 - “**Data**”: to only bar data.
 - “**Fax**”: to only bar faxes.
 - “**Message**”: to only bar short messages.
 - “**All Except Msgs**”: to bar all services other than short messages.
- When you have selected the call bar type and service, you can press the **up/down keys** to select

the following operations:

- **“On”**: to activate this bar.
- **“Off”**: to cancel this bar.
- **“Status”**: to view whether the bar is already activated,

- Select **“Cancel All”** to cancel all call bars which have been activated.

Note: You must enter your network password to set or cancel the NetworkCall Bar. If you consecutively enter the incorrect network password, the NetworkCall Bar service will be automatically locked. You must unlock the service via your network provider.

4.10.5.5 Fixed Dialing

If your SIM card supports it, outgoing calls can be restricted to certain numbers. When this function is activated, you may only dial the numbers that are in the fixed dialing list, or numbers that have the same initial numbers as those on the fixed dialing list.

Enter the **“Fixed Dialing”** submenu. You can make the following settings:

- **“Settings”**: to select to turn on or off the fixed dialing functions.

- **“List”**: when the fixed dialing list appears, press the **right soft key “MENU”** to carry out the desired operations.

Note: You need to enter your PIN2 number to turn on or off the Fixed Dialing function. Please contact your network provider to obtain the PIN2 number. After turning on the Fixed Dialing function, only numbers in the fixed dialing number list are displayed in the phone book.

4.10.6 Reset Settings

Enter the **“Reset Settings”** submenu. Here you can restore the relevant settings to the manufacturer’s settings.

Note: Restoring the manufacturer’s settings requires the correct handset lock code to be entered. Some settings cannot be restored to the manufacturer’s settings until the phone is restarted.

4.11 Camera

In the main menu interface Press the **navigation keys** to scroll to **“Camera”**. It includes two options: **“Digital Camera”** and **“Album”**.

4.11.1`Digital Camera

This mobile phone is equipped with a high resolution camera which you can use to take pictures at anytime or place and then save them on your mobile phone, use them as your mobile phone wallpaper or send them to your friends and colleagues via MMS.

Enter the “**Digital Camera**” submenu. Now the camera is in view-finding mode. The internal screen will show the viewing window. You can change the viewing window from the internal to external screen by opening and closing the lid of the mobile phone.



4.11.1.1Camera Settings

During the view-finding mode, the camera setting options are displayed on the bottom line of the screen.

Each camera setting option includes **setting items** and **adjustment items**, which are each marked by a different small icon. Look at the icon between the []. Press the **left/right keys** to switch between the camera **setting items**; press the **up/down keys** to set **adjustment items** on the selected camera setting items.

Note: Press ***Key** hide/display taking photo setting options.



- **Zoom**: to adjust the focus of the camera. The default setting is for normal []. Press the **down key** [] to move the focus in, and press the **up key** to increase the focal distance [].

Image effect: to set the colour style the pictures are taken as. These include: : “**Normal**”















[] 、 “**Black&White**” [] 、

“**Sepia**” []、 “**Inverse**” []、 Oil []、

Embossment [] 、 “**Copper**

Carve [] 、 ”

“**Jean**” []、 ”**Sketch**” []、 ”**Crayon**” []” 。 ,

- **Photo Frame:** to select a picture frame for the picture being taken. You can select from **No-frame** [, **Frame 1** [, **Frame 2** [, and **Frame 3** [].
- **Lightness:** to adjust the brightness of the photo. There are 5 levels in total [, [, [, [, [, the higher the level, the brighter the picture.
- **Rotation:** to adjust the angle of the camera's viewfinder. This includes **Off** [] and **180°** [].
- **Picture size:** to set the size at which the picture being taken will be saved. This includes (128*160) [, (320*240) [, (400*300) [, (640*480) [].

4.11.1.2 Shooting

Under shooting status, adjust viewfinder, make the selecting items display on the photo frame.

- Before taking the picture you can use the

navigation keys (up/down, right/left keys) to make the camera settings; or press the **right soft key**, “**OPTION**”, to carry out the “**Shutter Mode**”, “**Image Effect**”, “**Transparency**”, “**Picture Size**”, “**Auto Save**”, “**Sound**”, “**Night mode**”, “**White balance**”, “**Strobe light**” and “**Storage**” settings.

- “**Shutter Mode**”: to set the usable shot mode of camera as **Normal shutter** or **delay shutter**. “**Delay shutter**” mode means your mobile phone will automatically take the picture at the end of six seconds when the **left soft key** “**SHOT**” is pressed.
- “**Image Effect**”: to set the colour style of the photo. Styles include “**Normal**”, “**Black&White**”, “**Sepia**”, “**Inverse**”, “**Oil**”, “**Embossment**” and “**Fog**”, **Copper Carve**, **Jean**, **Sketch**, **crayon**.
- “**Transparency**”: to set a transparency for the photo taken. There are four options: **None**, **Transparency1**, **Transparency2** and **Transparency3** for you to select. **Note**: only the **Picture Size** as **Wallpaper (128*160)**, the **Transparency** option will be seen.
 - “**Picture Size**”: to set the size of photo. The wallpaper size includes: (128*160),

320*240、400*300、(640*480.

-“**Auto Save**”: to set whether to save the taken photo ; if the setting is “On”, photos are saved automatically with a default file name after finishing shooting, then back to shooting status and you can continue to take photos.

Sound: If you choose one of thress sounds, the camera will shoot with sound and remind that it is shooting, there are three sounds for your option or you can turn off the sound (set “**None**”)

- **White Balance: White balance:** Adjust the ray balance, including **Auto, Daylight , Tungsten,, lighting. 1, Cloudy, lighting2**

- “**Storage**”: to set the storage position of the movie taken as the “Phone” or “Memory card”.

■ After framing the picture you wish to take, keep the vidicon steady.

Press the **Left Soft Key “Shot”** or **Shooting Key** to take photos.

■ After taking the picture, the photo appears on the screen (if the lid of the mobile phone is closed please open it). Press the **left soft key,**

“SAVE”, to save the current picture. The default filename which the photo will be saved under the mobile phone time when the picture was taken (month /day /hour /min /sec). You can also edit the file name and press the **left soft key** to confirm. After the photo is saved to the **“Album”** submenu of the **“Camera”**, you will be returned to the view-finding mode; or press **Right Soft Key** not to save and return to the view-finding mode to continue shooting.

Note:

2. You can view the taken pictures from submenu **[Digital Camera]/[Album]**
3. You can also view the taken pictures from submenue **“PHOTOS”** of **[Extra] / [Playroom] / [File viewer]**.

4.11.2 Album

“Album” can store the pictures taken with your digital camera.

Enter the **“Album”** submenu. You will see a list of all the pictures in the selected memory. Press the **up/down keys** to scroll and select a picture. Press the **left soft key “VIEW”** to view the picture, or press the

function key **"MENU"** to perform the **"Rename"**, **"Delete"**, **"Wallpaper On"**, **"Wallpaper Off"** or **"Send via MMS"** operation on this picture or select **"Delete All"** to delete all the pictures in the selected memory.

4.12 Extras

In the main menu interface, press the **navigation keys** to scroll to **"Extras"**. You can use such practical functions of your mobile phone, as the **Playroom** **"Alarm"**, **"Calculator"**, **"Clock Setting"** and **"STK USB mode**

4.12.1 Playroom

Your mobile phone supports the various pastime functions. In the main menu interface, press the **navigation keys** to scroll to **"Playroom"**. In this menu you can use some practical functions for your pleasure. These include **"MP3"**, **"Java"**, **"Mobile QQ"**, **"File Viewer"** and **Record**.

4.12.1.1 Fun encyclopedia

Enter **Fun Encyclopedia** submenu, you can use various value-added services. Those services include

Game Paradise, Love Augury, QQ World, Graphics and Rings, Suring on line, News English etc..Those services may charge extra fees, please look up some relevant helpful information or inquire your retailers before usage. (The service will not show in some SIM card)

4.12.1.2 MP3

Your mobile phone supports to play music with MP3 format.

Enter the “**MP3**” submenu to open the MP3 player. You may play the music which is saved in the “MP3” submenu under “file viewer”.

Press **Function key** to start playing the music marked with a tick in the MP3 list or make a pause.

Press **Down key** to stop playing the current music.

Press **Left key** to play previous music marked with a tick in the MP3 list.

Press **Right key** to play next music marked with a tick in the MP3 list.

Press **Calling key** to switch between playing the music marked with a tick circularly in the MP3 list and just playing selected music.

Press **Up key** to enter the list of MP3 music, press **Up/down keys** to scroll to the desired music in list, press **left soft key** to mark this music with a tick or remove this music from marked list. You may press **function key** to select “**Select all**” quickly to make all the music with a tick in MP3 list, or select “**Cancel all**” to remove all the music from the selected list.

Press **Left soft key “Settings”** to set the **Volume settings**, **Cycle settings** (All cycle, Single cycle, random play), **Eq effect** (NORMAL, CLASSIC, HALL, JAZZ, ROCK, SOFTROCK or 3D) .

Press **End key** or **Right soft key** to close the MP3 player.

Note: You will get the better audio effect when you listen to MP3 music with stereo earphone.

4.12.1.3 Java

Your mobile phone supports Java application programs and is equipped with built-in Java games especially developed for your mobile phone. Your mobile phone also allows you to download new Java application programs.

Enter the “**Java**” submenu. You will see the following options: **Java Gallery**, **Download More** and

Settings.

4.12.1.4 Mobile QQ

Enter Mobile QQ submenu, you can use mobile QQ service. Press **Up/Down Key** to select **ID, Password, Save** options.

Note: it needs GPRS service supports while using mobile QQ function, which will cause extra **GPRS data stream**, please inquire your network operator about the usability and price information of GPRS service.

File viewer

Your mobile phone supports file management function.

Enter the "**File view**" submenu. You may view the status of USB disk including Phone memory and TFlash card and perform corresponding operation by the file viewer.

You may see the following file directories under the "**Phone memory**" submenu:

"**AMR**" is to save the audio file recorded by recorder. This directory is created automatically by system when saving the audio file recorded by recorder.

“**PHOTOS**” is to save the photo taken by digital camera. This directory is created automatically by system when saving the photo taken by digital camera.

“**FILM**” is to save the movie taken by vidicon. This directory is created automatically by system when saving the movie taken by vidicon.

“**MP3**” is to save the music with the MP3 and MIDI format. This directory is created automatically by system when the MP3 player is started up firstly.

Press **function key “Menu”** to perform five kinds of the operations:

1) On file directory

Info: to view the information of the current directory.

Delete: to delete the current file directory.

Rename: to rename the current file directory.

New Folder: to create a new file folder.

2) On picture file

View: to browse the picture.

Send via MMS: to send this picture to other person via MMS.

Info: to view the information of the current picture file.

Set Wallpaper: to set the current picture as

wallpaper of main LCD.

Delete: to delete the current picture.

Rename: to rename the current picture.

New Folder: to create a new file folder.

3) On audio file

Play: to play the current audio file.

Send via MMS: to send the audio file with MID or mmf format to other person via MMS.

Info: to view the information of the current audio file;

Set Ring tone: to set the audio file with MID format as the incoming call ring.

Delete: to delete the current audio file.

Rename: to rename the current audio file.

New Folder: to create a new file folder.

Note: the “**Send via MMS**” option is invisible to the audio file with MP3 format.

4) On text file

View: to browse the content of text file.

Info: to view the information of text file.

Delete: to delete the current text file.

Rename: to rename the current text file.

New Folder: to create a new file folder.

5) On movie file

Play: to player the current movie file.

Info: to view the information of movie file.

Delete: to delete the current movie file.

Rename: to rename the current movie file.

New Folder: to create a new file folder.

4.12.1.6 Record

Your mobile phone is equipped with built-in recorder especially.

Enter the “**Record**” submenu. You can see the following options: **Recorder** and **File List**

- Select “**Recorder**” to open the recorder. Press the **left soft key** to start recording or press the **right soft key** to stop recording and save the audio file to “**File List**” submenu.
- In the “**File List**” submenu, press the **up/down key** to select the audio file. Here you can perform the following operation: **Play**, **Rename**, **delete** the selected audio file or **delete all** the files in the submenu.

4.12.2 Alarm

Enter the “**Alarm**” submenu. You can use the alarm service available with your mobile phone. You

can set a maximum of two alarms. To set one alarm, select it firstly by the **up/down keys** and press the **left soft key** to enter the alarm setting interface, then press the **up/down keys** to select and set the on/off switch, time, repeat period and ring sound of the selected alarm.

On/off switch: to turn on and off the alarm. The alarm service is only in effect when the alarm switch is set as “**On**”.

Alarm time: Use the **left/right keys** to switch between the hours and minutes; use the **number keys** to enter the time.

Repeat period: Use the **left/right keys** to select “**Everyday**”, “**One Time**”, “**Mon. to Fri.**” and “**Mon. to Sat.**” in sequence.

Alarm ring sound: Use the **left/right keys** to select the type of alarm ring sound. You can select one ring type from the 20 internal ring sounds to serve as your alarm ring sound.

4.12.3 Calculator

Your mobile phone provides a calculator with 4 basic functions to facilitate simple calculations.

Enter the “**Calculator**” submenu to display the

operation interface of the calculator:

- Use the **Number keys** from **0** to **9** to enter the numbers you wish to enter, use the **# key** to enter the decimal point.

- Press the **up/down keys** and **left/right keys** to enter the symbols for the four mathematical operators $+$, $-$, \times or \div .

- By pressing **Right soft key** you can delete the latest entry or result, press the **right soft key**, "**EXIT**", to exit the calculator, press the **left soft key**, "**=**" to calculate the result.

Note: The precision of this calculator is limited so that rounding errors may occur, especially in the case of indivisibility.

4.12.4 Clock Setting

Enter the "**Clock Setting**" submenu to make time related settings such as: "**Auto Power On**", "**Auto Power Off**", "**Set Time**", "**Set Date**", "**Journey**" and "**Set Time Zone**".

4.12.4.1 Auto Power On

Enter the "**Auto Power On**" submenu to use the automatic power on service provided by your mobile

phone. The specific method of setting is the same as for the alarm (with the exception of the ring sound setting).

4.12.4.2 Auto Power Off

Enter the “**Auto Power Off**” submenu to use the automatic power off service provided by your mobile phone. The specific method of setting is the same as for the alarm (with the exception of the ring sound setting).

4.12.4.3 Set Time

Enter the “**Set Time**” submenu to set the current time and date of your mobile phone. Use the **navigation keys** to switch among the hour, minute, year, month and day options; use the **number keys** to enter the corresponding number.

Note:

- 1) The mobile phone uses a 24-hour clock.
- 2) The mobile phone will permit you to enter a day from between 2001 to 2049.

4.12.4.4 Journey

Journey helps you to manage the various duties in

your work and life and to plan and record the matters you will perform. When the time has come to do something previously planned, your mobile phone will ring reminding you to complete the planned matter.

Enter the “**Journey**” submenu. A calendar will be displayed on the screen and the current day will be marked with a specially colored frame. Press the **navigation keys** to change the date and the information displayed on the calendar shall change correspondingly. Press the **left soft key**, “**MENU**”, to view the following menu options: **Add New**, **Today Journey**, **Journey List**, **Journey Search**, **Date Search**, **Delete One** and **Delete All**.

4.12.4.4.1 Add New

Select **Add New** to create a new Journey item. You can press the **up/down keys** to scroll to select and edit the Journey’s **Date**, **Time**, **Title**, **Alarm**, **Repeat**, **Ring**, or **Annotations** options. The current option is marked with a colored frame.

Date: to set the start date for the execution of a Journey item.

Time: to set the time scope within which a Journey item should be completed.

Title: to edit the subject of a Journey item.

Alarm: to set whether the alarm will remind you when the start time of a Journey item has been reached.

Repeat: to set to repeat at intervals of “One Time, Mon.to Fri., Mon.to Sat. or Everyday”.

Ring: to set the alarm ring for a Journey item.

Annotations: to edit the detailed contents of a Journey item.

Note: The mobile phone reserves a certain amount of available memory space especially for Journey. You may create a maximum of 20 Journey items. When the mobile phone indicates that the memory is full, you must delete unimportant Journey entries before you will be able to create new ones. The Repeat and Ring settings will only work when the **Alarm** is set to “**On**” for a Journey item.

4.12.4.4.2 Today Journey

Select **Today Journey** to display the Journey log for the current date. Press the **up/down keys** to select a Journey item and press the **left soft key, “View”**, to view or modify the contents of the selected Journey item.

Note: If the Journey log in the **Today Journey** menu is blank, your mobile phone will indicate that there are no

entries.

4.12.4.4.3 Journey List

Select **Journey List** to display all Journey logs. Press the **up/down keys** to select a Journey item and press the **left soft key**, “**View**”, to view or modify the selected contents of a Journey item.

Note: If Journey log in the **Journey List** menu is blank, your mobile phone will indicate that there are no entries.

4.12.4.4.4 Journey Search

Select **Journey Search** and your mobile phone will prompt you to input the key words corresponding to the title of the Journey. After completing the input, press the **left soft key** to confirm. The search result will display those Journey items corresponding to the key words entered. Press the **up/down keys** to select a Journey item and press the **left soft key**, “**View**”, to view or modify the selected contents of the Journey item.

Note: You cannot leave the key word blank. If the key word entered does not correspond to the title of any of the journey items, the mobile phone will indicate that no matching records were found.

4.12.4.4.5 Date Search

Select **Date Search** and the mobile phone will prompt you to enter the date for which you wish to search. After entering, press the **left soft key** to confirm. The search result will display those Journey item corresponding to the desired date. Press the **up/down keys** to select a Journey item and press the **left soft key**, "**View**", to view or modify the selected contents of the Journey item.

Note: If there are no Journey items for the desired date, your mobile phone will indicate that there are no entries.

4.12.4.4.6 Delete One

Select **Delete One** to display all the Journey logs. Press the **up/down keys** to select a Journey item and then press the **left soft key**, "**DEL**", to delete the selected Journey item.

Note: If there are no Journey Logs, your mobile phone will indicate that there are no entries.

4.12.4.4.7 Delete All

Select **Delete All** and a query dialog box will appear

prompting you to confirm that you wish to delete all the Journey items. Press the **left soft key** to confirm and delete all the Journey items, or press the **right soft key** to cancel the **Delete All** operation.

Note: If there are no Journey items, your mobile phone will indicate that there are no entries.

4.12.4.5 Set Time Zone

Enter the “**Set Time Zone**” submenu and you will initially see the world clock browsing interface. Use the **navigation keys (up/down, right/left keys)** to select the world city time you wish to view. Press the **left soft key**, “**Ok**” to set the time zone; press the **right soft key**, “**Exit**” to end the time zone setting.

If you go to another country or city to travel, all you have to do is to use the **navigation keys** to move the time zone cursor to the country or city where you are on the world map and you will instantly get the local time.

4.12.5 STK

Enter the “**STK**” submenu. Here you can use the

value-added services provided by your network operator.

Your mobile phone supports STK functions. This service is provided by your network operator. If your SIM card and network operator do not provide this service, then you will not be able to use this function. For more information please contact your network operator.

4.11.6USB Mode

Your mobile phone supports use of **Usb disk and PC-camera**

Enter “**USB mode**” submenu, you can see **Usb disk** and **PC-camera** options.

Usb disk: use the handset as Usb disk.

PC-Camera: connect the camera with PC as a PC-camera usage. If you want to operate this function,connect your handset wih PC by USB data wire and install a correct disk,then select this option.

Note: some installing instruction of PC Camera Disk ,please refer to the attached << PC Camera Function Instruction>>

5. Input Mode

5.1 General outline

This mobile phone supports Chinese input and provides the following input modes: Pinyin input, Stroke order input, Stroke input, Smart English input, English uppercase input, English lowercase input, Number input, and commonly used symbols input. Character entry functions permitted by this mobile phone are:

- Inputting and editing of short messages
- Inputting and editing of names in the phone book
- Looking up the phone entry by name
- Editing of greeting and owner name
-

5.2 Keypad Introduction

The keypad functions are as follows. For keypad function specific to certain input modes please refer to **Section 6.3, Explanation of Input Mode.**

Generally the **Left soft Key** and **function key** indicate confirmation; the **right soft key** is to exit.

Function key: In Chinese character input mode

and English SE input mode, press the key to select word.

Navigation keys (up/down and left/right keys):

Generally used to move the cursor or candidate characters for inputting.

key: to switch between different input modes. An icon indicating the corresponding input mode will appear on the right side of the icon area:

Input mode icon	Explanation
拼	Pinyin input mode
顺	Stroke order input mode
画	Stroke input mode
SE	Smart English input mode
ABC	English uppercase input mode
abc	English lowercase input mode
123	Number input mode

Number keys from **2** to **9**: in the Pinyin and Smart English input modes, indicate the letters on the corresponding key; **Number keys** from **1** to **8**: in the Stroke order and Stroke input modes, indicate the strokes on the corresponding key;

*** key:** Under the Smart English input modes pressing the *** key** will bring up the input box for

English symbols; Under the Lowercase and Uppercase English input modes, pressing the * key brings up the input box for English symbols. Under the Chinese input modes, pressing the * key changes the pinyin candidates or brings up the input box for Chinese symbols.

5.3 Explanation of Input Modes

5.3.1 Pinyin Input Mode

In the Pinyin input mode, the keyboard values are as follows:

Key	Corresponding character, symbol or function	Explanation
Number key 0	space	
Number key 1	To cyclically select the tone for the selected pinyin	
Number key 2	abc	Pinyin symbols
Number key 3	def	
Number key 4	ghi	
Number key 5	jkl	

Number key 6	mno	
Number key 7	pqrs	
Number key 8	tuv	
Number key 9	wxyz	
* key	Pressing this key can make available cyclical selection of pinyin candidates or bring up the input box for Chinese symbols.	
# key	To switch input modes	
Up navigation key	To page up or move the cursor up	
Down navigation key	To page down or move the cursor down	
Left navigation key	To scroll to the left	
Right navigation key	To scroll to the right	

Left soft key	To confirm	
Right soft key	To delete or exit	
End key	To return to the standby interface	
function key	To confirm	

The usual order of operation for the Pinyin input mode is as follows:

- **Enter the pinyin letters:** Use the **number keys** from **2** to **9** to enter the pinyin of the Chinese character;
- **Select pinyin:** Use the *** key** to cyclically select a desirable pinyin combination. Use the **number key 1** to cyclically select a tone value for the selected pinyin. Use the **right soft key** to exit the current input or **end key** to return to the standby mode.
- **Select and enter a character:** Use the **up/down navigation keys** to flip through the candidate area for a desirable character. Use the **right/left navigation keys** to look for the character in the candidate area and the **left soft key** or **function key** to enter the character.
- **Enter associated characters:** Association input will provide the available candidates associated

with the former character. The **up/down navigation keys** can be used to flip through the candidate area, the **left/right navigation keys** to select a desired character in the candidate area, and the **left soft key** or **function key** to enter a desired character.

- **Enter Chinese symbol:** press * **key** to bring up the input box for Chinese symbols, the **navigation keys** to select the desired Chinese symbol and the **left soft key** or **function key** to enter the selected symbol.
- **Edit inputted text:** Use the **right /left navigation keys** to move the cursor left and right, the **up/down navigation keys** to move the cursor up and down, the **Right soft key** to delete characters.
- **Switch input modes:** Use the **# key** to cyclically switch between different input modes. An icon indicating the corresponding input mode will appear in the right side of the icon area:

5.3.2 Stroke Order Input Mode













In the Stroke order input mode, the keyboard values are as follows:

Key	Corresponding character, symbol or function	Explanation
Number key 0	Space	
Number key 1	Horizontal or rising line stroke	
Number key 2	Vertical stroke	
Number key 3	Left-falling stroke	
Number key 4	Right-falling stroke, dot	
Number key 5	Smooth turning stroke	A stroke with multiple turns being defined by the final turn. Refer to attached drawing.
Number key 6	Curved turning stroke	A stroke with multiple turns being defined by the final turn. Refer to attached drawing.

Number key 7	Reverse turning stroke	A stroke with multiple turns being defined by the final turn. Refer to attached drawing.
Number key 8	Vertical/horizontal turning stroke	A stroke with multiple turns being defined by the final turn. Refer to attached drawing.
* key	Press this key to bring up the input box for Chinese symbols	
# key	To switch input modes	
Up navigation key	To page up or move the cursor up	

Down navigation key	To page down or move the cursor down	
Left navigation key	To scroll to the left	
Right navigation key	To scroll to the right	
Left soft key	To confirm	
Right soft key	To delete or exit	
End key	To return to the standby interface	
function key	To confirm	

Attached drawing: A table of correspondences between pen strokes and pen stroke keys for the stroke order input mode.

1	2	3	4	5	6	7	8
							
							

The usual order of operation for the stroke order input mode is as follows:

- **Enter radical words and strokes:** press the corresponding **number keys** according to the stroke order of the Chinese character. Use the **navigation keys** to select the Chinese character and the **Right soft key** to delete the last entered stroke.
- **Select and enter a character:** Use the **up/down navigation keys** to flip through the candidate area for a desired Chinese character , use the **right/left navigation keys** to select a desired Chinese character in the candidate area, and use the **left soft key** or **function key** to enter the character.
- **Enter associated characters:** Association input will provide the available Chinese candidates associated with the former Chinese character. The **up/down navigation keys** can be used to flip through the candidate area, the **left/right navigation keys** to select a desired Chinese character in the candidate area, and the **left soft key** or **function key** to enter the character.
- **Enter Chinese symbol:** press the *** key** to bring up the input box for Chinese symbols, the **navigation keys** to select the desired Chinese symbol and the **left soft key** or **function key** to

enter the selected symbol.

- **Edit inputted text:** use the **right/left navigation keys** to move the cursor left and right, the **up/down navigation keys** to move the cursor up and down, the **Right soft key** to delete characters.

5.3.3 Stroke Input Mode

In the Stroke input mode, the keyboard values are as follows:

Key	Corresponding character, symbol or function	Explanation
Number key 0	Space	
Number key 1	Horizontal or rising line stroke	
Number key 2	Vertical stroke	
Number key 3	Left-falling stroke	
Number key 4	Right-falling stroke, dot	
Number key 5	Smooth turning stroke	A stroke with multiple turns being defined by the final turn.

		Refer to attached drawing.
Number key 6	Curved turning stroke	A stroke with multiple turns being defined by the final turn. Refer to attached drawing.
Number key 7	Reverse turning stroke	A stroke with multiple turns being defined by the final turn. Refer to attached drawing.
Number key 8	Vertical/horizontal turning stroke	A stroke with multiple turns being defined by the final turn. Refer to attached drawing.

* key	Press this key to bring up the input box for Chinese symbols	
# key	To switch input modes	
Up navigation key	To page up or move the cursor up	
Down navigation key	To page down or move the cursor down	
Left navigation key	To scroll to the left	
Right navigation key	To scroll to the right	
Left soft key	To confirm	
Right soft key	To delete or exit	
End key	To return to the standby interface	
function key	To confirm	

Attached drawing: A table of correspondences between pen strokes and pen stroke keys for the stroke input mode.

1	2	3	4	5	6	7	8
一	丨	丿	丶	㇇	㇏	㇏	㇏
㇇	丨		㇏	㇇		㇏	㇏
	丨		㇏	㇇		㇏	㇏

The usual order of operation for the stroke input mode is as follows:

- **Enter the strokes:** press the corresponding **number keys** following the standard stroke order for Chinese characters and the mobile phone will display the corresponding Chinese characters; you can enter Chinese character radicals using the Stroke input mode; you must use the **left soft key** to select a radical; the **Right soft key** can delete the last stroke entered.
- **Select and enter a character:** The **up/down navigation keys** can be used to flip through the candidate area, the **left/right navigation keys** to select a desired Chinese character in the candidate area, and the **left soft key** or **function key** to enter the character.
- **Enter associated characters:** Association input will provide the available Chinese candidates

associated with the former Chinese character. The **up/down navigation keys** can be used to flip through the candidate area, the **left/right navigation keys** to select a desired Chinese character in the candidate area.

- **Enter Chinese symbol:** press the * **key** to bring up the input box for Chinese symbols, the **navigation keys** to select the desired Chinese symbol and the **left soft key** or **function key** to enter the selected symbol.
- **Edit inputted text:** use the **right/left navigation keys** to move the cursor left and right, the **up/down navigation keys** to move the cursor up and down, the **Right soft key** to delete characters.

5.3.4 Smart English input Mode

In the Smart English input mode, the keyboard values are as follows:

Key	Corresponding character, symbol or function	Explanation
Number key 0	space	
Number key 2	abc	

Number key 3	def	
Number key 4	ghi	
Number key 5	jkl	
Number key 6	mno	
Number key 7	pqrs	
Number key 8	tuv	
Number key 9	wxyz	
* key	Pressing the * key will bring up the input box for English symbols.	
# key	To switch input modes	
Up navigation key	To move the cursor up or select a word	
Down navigation key	To move the cursor down or select a word	
Left navigation key	To move the cursor left or select a word	
Right navigation key	To move the cursor right or select a word	
Left soft key	To confirm	
Right soft key	To delete or exit	
End key	To return to the standby interface	

function key	To confirm	
--------------	------------	--

The usual order of operation for the Smart English input mode is as follows:

- Each key is used to enter the letters corresponding with such keys. It will also automatically form words according to the preceding entry. Please press the corresponding keys in turn according to the desired letter or word, Use the **navigations keys** to select a desired letter or word, the **left soft key** or **function key** to enter the letter or word.
- Use the **# key** to switch between input modes.
- Use the *** key** to bring up the input box for English symbols, the **navigation keys** to select the desired English symbol, and the **left soft key** or **function key** to enter the selected symbol.
- Press the **Number key 0** to enter space.
- Press the **Right soft key** to clear mistake input and press and hold the **Right soft key** to clear the entire entry.

5.3.5 English uppercase and lowercase input mode

Keyboard values for inputting English letters are as follows:

Key	Corresponding character, symbol or function	Explanation
Number key 0	space	
Number key 1	., ? !	
Number key 2	ABCabc	
Number key 3	DEFdef	
Number key 4	GHIghi	
Number key 5	JKLjkl	
Number key 6	MNOmno	
Number key 7	PQRSpqrs	
Number key 8	TUVtuv	
Number key 9	WXYZwxyz	
* key	pressing the * key brings up the input box for English symbols.	
# key	To switch input modes	
Up navigation key	To move the cursor up	
Down navigation key	To move the cursor down	
Left navigation key	To move the cursor left	

Right navigation key	To move the cursor right	
Right soft key	To exit	
Right soft key	Clear	
End key	To return to the standby interface	
function key	To confirm	

The usual order of operation for inputting English is as follows:

- Each key is used for entering multiple characters. Rapidly press the key until the required character appears.
- When you need to input English punctuation symbols, in the English letter input mode (including uppercase and lowercase letters) repeatedly press the **Number key 1** until the required symbol appears.
- When you need to input certain special symbols, in the English input mode (including uppercase and lowercase letters) pressing the *** key** brings up the input box for English symbols.
- Use the **# key** to switch between input modes.
- When you need to enter a space, in either the uppercase or lowercase mode, press the **number key 0** once.
- Press the **Right soft key** to clear mistaken input and press and hold **Right soft key** to clear the entire entry.

5.3.6 Number input mode

The keyboard values for the number input mode are as follows:

Key	Corresponding character, symbol or function
Number key 0	0
Number key 1	1
Number key 2	2
Number key 3	3
Number key 4	4
Number key 5	5
Number key 6	6
Number key 7	7
Number key 8	8
Number key 9	9
# key	To switch input modes
Up navigation key	To move the cursor up
Down navigation key	To move the cursor down

Left navigation key	To move the cursor left
Right navigation key	To move the cursor right
Left soft key	To confirm
Right soft key	To delete or exit
End key	To return to the standby interface

The usual order of operation for inputting numbers is as follows:

- Press the **number keys** from **0** to **9** to input the corresponding numbers.
- Press the **# key** to switch between input modes.
- Press the **Right soft key** to clear mistaken input and press and hold the **Right soft key** to clear the entire entry.

6. Troubleshooting

If anything unusual occurs while using your mobile phone, please refer to the following table.

Frequently Occurring Problems	Cause	How to Fix
Poor reception	Using the mobile phone in an area with poor reception such as near tall buildings or in a basement where radio waves cannot be transmitted.	Try to avoid.

	Using the mobile phone when the network is busy, such as during rush hour, when the lines are full making and it impossible to get through.	Try to avoid.
	Related to the distance from the base station built by the network.	You can ask the network service operator to provide a service area plan.
Echo or noise	Caused by poor network relay, a regional problem.	Hang up and redial, if the relay is changed then the line may be better.
	Some calling regions have poor lines.	

Shortening of the standby time	Standby time is related to the network system.	Please temporarily turn off your mobile phone, as you are located in an area with poor reception.
	Need to change for a new battery	Change a new battery
	When you cannot get a signal, the phone will continue to transmit in order to find a base station, thereby use up a large of power and shorten the standby time	Please move to an area with a strong signal or temporarily turn off your mobile phone.
Unable to turn on the	The battery is used up.	Look at the remaining

phone		electricity or recharge.
SIM card malfunction	SIM card is damaged.	Contact your network service operator.
	SIM card is not properly inserted.	Check whether SIM card is properly inserted.
	There is a feculency substance on the metal surface of the SIM card.	Wipe the metal touch part of SIM card with clean cloth.
Unable to connect with the network	Expired SIM card	Contact your network operator.
	Outside the GSM service area	Consult your network provider on the service area.

	Poor signal.	Please move to a place with a better signal and try again.
Unable to make a call	Using the call bar function	Cancel the call bar function.
	Using the fixed dialling function.	Cancel the fixed call setting.
Incorrect PIN number	Continuously enter the wrong password three times.	Contact your network operator.
Unable to charge	Battery or charger is damaged.	Change a new battery or charger.
	Recharging in the environment of less than -10°C or higher than 55°C.	Improve the charging environment.

	Poor contact	Check if the plug is properly connected
Unable to add new phone book entries	The storage space of the phone book is full	Delete a portion of the phone number entries
Unable to set certain functions	Your network provider does not support this function or you have not applied for it.	Contact your network operator.

