

## Contents

### Before driving

**Introduction** 2

**Instrumentation** 6

**Controls and features** 27

**Seating and safety restraints** 105

### Starting and driving

**Starting** 139

**Driving** 144

**Roadside emergencies** 170

### Servicing

**Maintenance and care** 192

**Capacities and specifications** 246

**Customer assistance** 252

**Reporting safety defects** 264

**Index** 265

All rights reserved. Reproduction by any means, electronic or mechanical including photocopying, recording or by any information storage and retrieval system or translation in whole or part is not permitted without written authorization from Ford Motor Company. Ford may change the contents without notice and without incurring obligation.

Copyright © 2000 Ford Motor Company

# Introduction

The following warning may be required by California law:

## CALIFORNIA Proposition 65 Warning



**WARNING:** Engine exhaust, some of its constituents, and certain vehicle components contain or emit chemicals known to the State of California to cause cancer and birth defects or other reproductive harm. In addition, certain fluids contained in vehicles and certain products of component wear contain or emit chemicals known to the State of California to cause cancer and birth defects or other reproductive harm.

## ICONS

Indicates a safety alert. Read the following section on *Warnings*.



Indicates vehicle information related to recycling and other environmental concerns will follow.



Correct vehicle usage and the authorized disposal of waste cleaning and lubrication materials are significant steps towards protecting the environment.

Indicates a message regarding child safety restraints. Refer to *Seating and safety restraints* for more information.



Indicates that this Owner Guide contains information on this subject. Please refer to the Index to locate the appropriate section which will provide you more information.



## WARNINGS

Warnings provide information which may reduce the risk of personal injury and prevent possible damage to others, your vehicle and its equipment.

### **BREAKING-IN YOUR VEHICLE**

There are no particular breaking-in rules for your vehicle. During the first 1 600 km (1 000 miles) of driving, vary speeds frequently. This is recommended to give the moving parts a chance to break in.

### **INFORMATION ABOUT THIS GUIDE**

The information found in this guide was in effect at the time of printing. Ford may change the contents without notice and without incurring obligation.

### **EMISSION WARRANTY**

The New Vehicle Limited Warranty includes Bumper to Bumper Coverage, Safety Restraint Coverage, Corrosion Coverage, and 7.3L Power Stroke Diesel Engine Coverage. In addition, your vehicle is eligible for Emissions Defect and Emissions Performance Warranties. For a detailed description of what is covered and what is not covered, refer to the *Warranty Guide* that is provided to you along with your Owner's Guide.

# Introduction

These are some of the symbols you may see on your vehicle.

## Vehicle Symbol Glossary

Safety Alert		See Owner's Guide	
Fasten Safety Belt		Air Bag-Front	
Air Bag-Side		Child Seat	
Child Seat Installation Warning		Child Seat Tether Anchorage	
Brake System		Anti-Lock Brake System	
Brake Fluid - Non-Petroleum Based		Traction Control	
Master Lighting Switch		Hazard Warning Flasher	
Fog Lamps-Front		Fuse Compartment	
Fuel Pump Reset		Windshield Wash/Wipe	
Windshield Defrost/Demist		Rear Window Defrost/Demist	
Power Windows Front/Rear		Power Window Lockout	

## Vehicle Symbol Glossary

Child Safety Door  
Lock/Unlock



Interior Luggage  
Compartment Release  
Symbol



Panic Alarm



Engine Oil



Engine Coolant



Engine Coolant  
Temperature



Do Not Open When Hot



Battery



Avoid Smoking, Flames,  
or Sparks



Battery Acid



Explosive Gas



Fan Warning



Power Steering Fluid



Maintain Correct Fluid  
Level



Emission System



Engine Air Filter



Passenger Compartment  
Air Filter



Jack



Check fuel cap



# Instrumentation

Turn signal and  
wiper/washer control  
(pg. 73)

Instrument cluster  
(pg. 8)

Driver air bag  
(pg. 122)

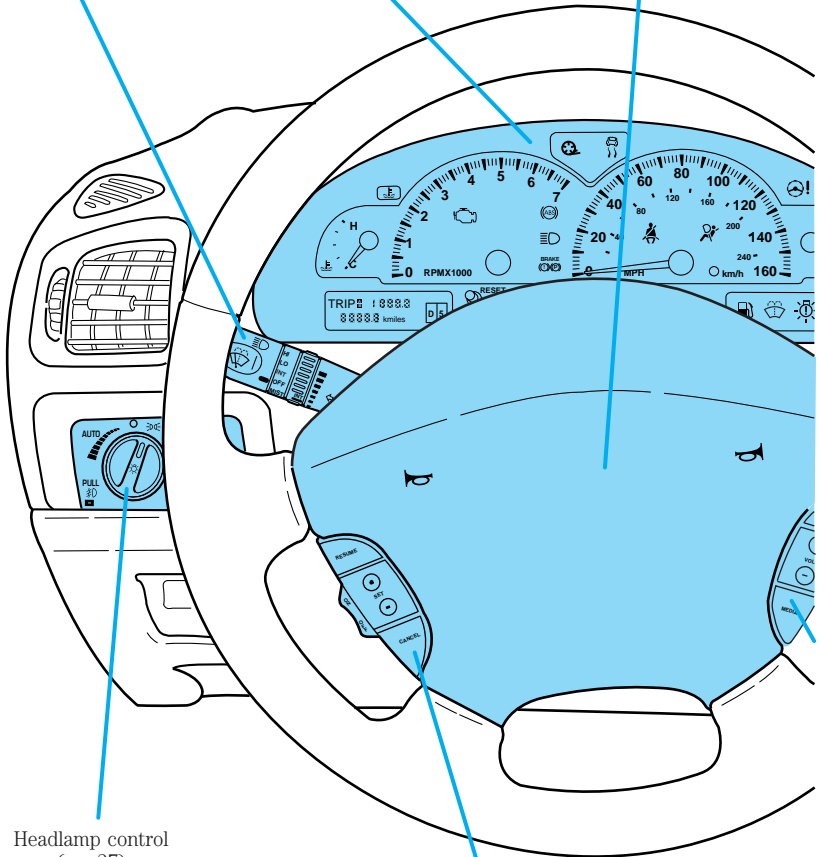

Headlamp control  
(pg. 27)

Autolamp control  
(pg. 29)

Speed control  
(pg. 77)

# Instrumentation

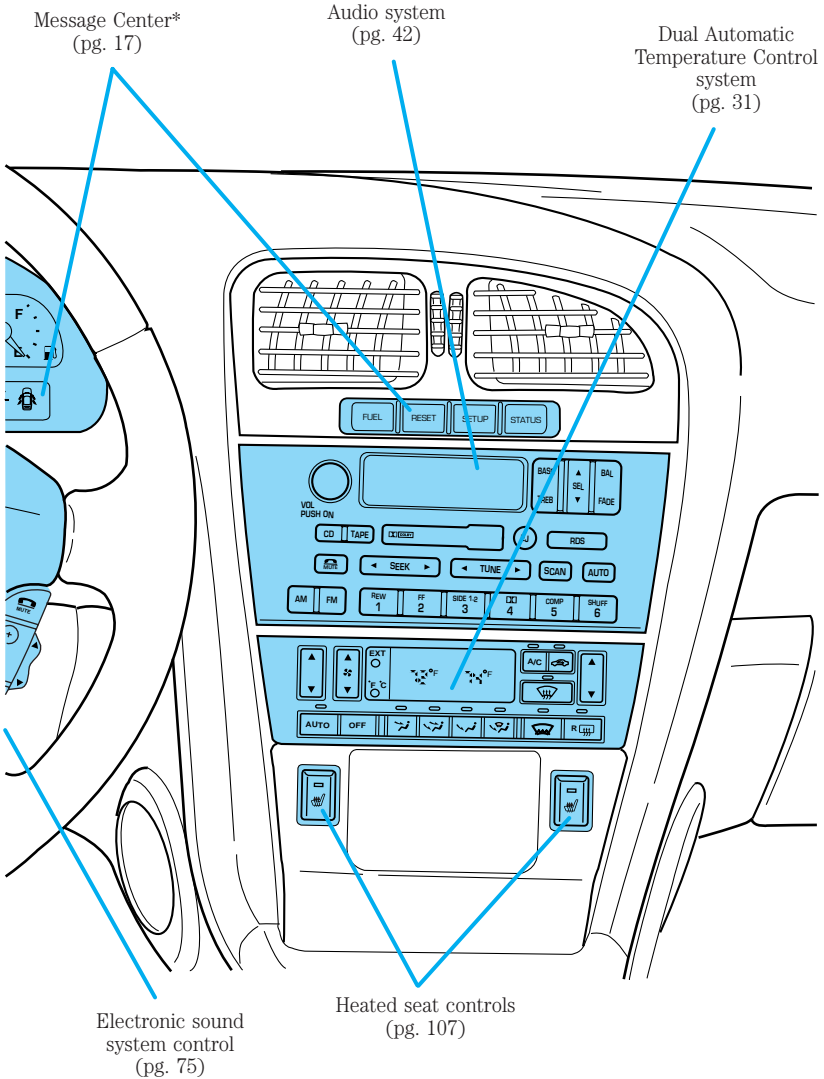

\* if equipped

# Instrumentation

## WARNING LIGHTS AND CHIMES

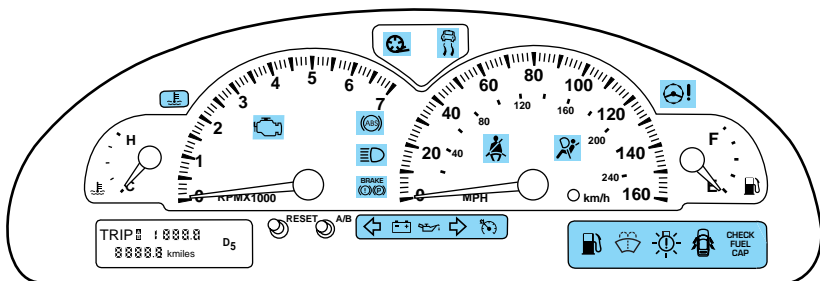

### Engine coolant temperature

Illuminates when the engine coolant temperature is high. Stop the vehicle as soon as safely possible, switch off the engine and let it cool.



 Never remove the coolant recovery cap while the engine is running or hot.

Refer to *Engine coolant* in the *Maintenance and care* chapter. If light stays on or continues to turn on after the vehicle warms up, have your vehicle serviced.

This light also illuminates briefly when the ignition key is turned to RUN.

### Check engine

Your vehicle is equipped with a computer that monitors the engine's emission control system. This system is commonly known as the On Board Diagnostics System. This system protects the environment by ensuring that your vehicle continues to meet government emission standards. The system also assists the service technician in properly servicing your vehicle.



The *Check Engine* indicator light illuminates when the ignition is first turned to the RUN position to check the bulb. If it comes on after the engine is started, one of the engine's emission control systems may be



malfunctioning. The light may illuminate without a driveability concern being noted. The vehicle will usually be drivable and will not require towing.

### ***What you should do if the check engine light illuminates***

#### **Light turns on solid:**

This means that the On Board Diagnostics System system has detected a malfunction.

Temporary malfunctions may cause your *Check Engine* light to illuminate. Examples are:

1. The vehicle has run out of fuel. (The engine may misfire or run poorly.)
2. Poor fuel quality or water in the fuel.

These temporary malfunctions can be corrected by filling the fuel tank with high quality fuel of the recommended octane. After three driving cycles without these or any other temporary malfunctions present, the *Check Engine* light should turn off. (A driving cycle consists of a cold engine startup followed by mixed city/highway driving.) No additional vehicle service is required.

If the *Check Engine* light remains on, have your vehicle serviced at the first available opportunity.

#### **Light is blinking:**

Engine misfire is occurring which could damage your catalytic converter. You should drive in a moderate fashion (avoid heavy acceleration and deceleration) and have your vehicle serviced at the first available opportunity.



Under engine misfire conditions, excessive exhaust temperatures could damage the catalytic converter, the fuel system, interior floor coverings or other vehicle components, possibly causing a fire.

### **Anti-lock brake system (ABS)**

Momentarily illuminates when the ignition is turned to the RUN position to ensure the circuit is functional. If the light remains on, continues to flash or fails to



illuminate, have the system serviced immediately. With the ABS light on,

## Instrumentation

the anti-lock brake system is disabled and normal braking is still effective unless the brake warning light also remains illuminated with the parking brake released.

### Turn signal

Illuminates when the left or right turn signal or the hazard lights are turned on. If one or both of the indicators flash faster, check for a burned-out turn signal bulb. Refer to *Bulbs* in the *Maintenance and care* chapter.

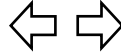

### High beams

Illuminates when the high beam headlamps are turned on.



### Brake system warning

Momentarily illuminates when the ignition is turned to the RUN position to ensure the circuit is functional. Also illuminates if the parking brake is engaged. If the brake warning lamp does not illuminate at these times, or remains on after releasing the parking brake, seek service immediately.

**BRAKE**

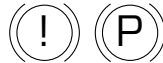

One of the following conditions may exist:

- low brake fluid level in the reservoir.
- Brake force distribution system failure. The ABS light will also illuminate if this condition is present.

### Charging system

Illuminates when the ignition is turned to the RUN position and the engine is off. The light also illuminates when the battery is not charging properly, requiring electrical system service.

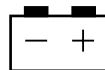

### Engine oil pressure

Momentarily illuminates when the ignition is turned to the RUN position and the engine is off.

Illuminates when the oil pressure falls below the normal range. Stop the vehicle as soon as safely possible and switch off the engine immediately. Check the oil level and add oil if needed. Refer to *Engine oil* in the *Maintenance and care* chapter.

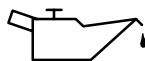

### Safety belt

Momentarily illuminates when the ignition is turned to the RUN position to remind you to fasten your safety belts. For more information, refer to the *Seating and safety restraints* chapter.



### Air bag readiness

Momentarily illuminates when the ignition is turned to the RUN position. If the light fails to illuminate, continues to flash or remains on, have the system serviced immediately.



### Low fuel (if equipped)

Illuminates as an early reminder of a low fuel condition indicated on the fuel gauge. The ignition must be in the RUN position for this lamp to illuminate. The lamp will also

illuminate for several seconds after the ignition is turned to the RUN position regardless of the fuel level (refer to *Fuel gauge* in this chapter for more information).



## Instrumentation

### Low washer fluid (if equipped)

Illuminates when the ignition is turned to RUN and when the windshield washer fluid is low.



### Bulb Warning (if equipped)

Illuminates when the ignition is in the RUN position and one of the exterior bulbs has burned out.



### Traction Control™ active

Flashes when the Traction Control™ system begins applying and releasing the brakes and adjusting the engine characteristics to limit a wheelspin condition. If the light remains on, have the system serviced immediately.

For more information, refer to the *Driving* chapter.



### AdvanceTrac (if equipped)

Flashes when the AdvanceTrac system begins applying and releasing the brakes and/or adjusting the engine characteristics to limit a sideways wheelspin condition. If the light remains on while the engine is running, have the system serviced immediately.

For more information, refer to the *Driving* chapter.



### Steering column lock (manual transmission only)

Momentarily illuminates when the ignition is turned to the RUN position. If this light stays illuminated, steering column will be locked, and the vehicle will not start. Have the vehicle serviced immediately.



### Speed control

This light comes on when the vehicle speed control is engaged and actively controlling the vehicle speed. It turns off when the speed control OFF or CANCEL controls are pressed or the brake is applied.



### Door ajar (if equipped)

Illuminates when the ignition is in the RUN position and any door or the trunk is open.



### Check fuel cap (if equipped)

Momentarily illuminates when the ignition is turned to the RUN position to ensure your bulb is working. When this light turns on, check the fuel filler cap. Continuing to operate the vehicle with the

check fuel cap light on, can activate the *Service Engine Soon/Check Engine* warning light. When the fuel filler cap is properly re-installed, the light(s) will turn off after a period of normal driving. This period will vary depending on driving conditions.



**It may take a long period of time for the system to detect an improperly installed fuel filler cap.**

For more information, refer to *Fuel filler cap* in the *Maintenance and care* chapter.

### Transmission PRNDL indicator

Your vehicle is equipped with a transmission PRNDL indicator. This character appears with the key in the RUN position and displays the gear selected on the gearshift floor console.

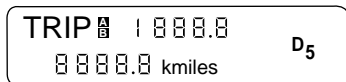

## Instrumentation

If an “E” character is displayed, this indicates a transmission malfunction. If the “E” character flashes or remains on, contact your dealer immediately. Operating the transmission with the “E” character illuminated may cause additional damage to the transmission.

### Headlamps on warning chime

Sounds when the headlamps or parking lamps are on, the ignition is off (and the key is not in the ignition) and the driver’s door is opened.

### Safety belt warning chime

Sounds to remind you to fasten your safety belts.

For information on the safety belt warning chime, refer to the *Seating and safety restraints* chapter.

### Belt minder chime

Sounds intermittently to remind you to fasten your safety belts.

For information on the safety belt minder chime, refer to the *Seating and safety restraints* chapter.

### Supplemental restraint system (SRS) warning chime

For information on the SRS warning chime, refer to the *Seating and safety restraints* chapter.

### Key-in-ignition warning chime

Sounds when the key is left in the ignition in the OFF/LOCK or ACC position and the driver’s door is opened.

### Turn signal chime

Sounds when the turn signal lever has been activated to signal a turn and not turned off after the vehicle is driven more than 0.8 km (1/2 mile).

## GAUGES

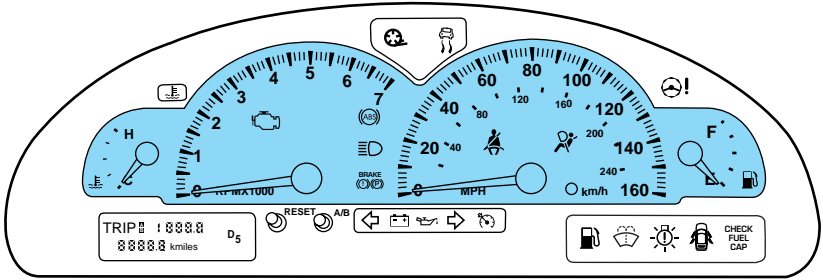

### Engine coolant temperature gauge

Indicates the temperature of the engine coolant. At normal operating temperature, the needle remains within the center of the gauge. If it enters the “H” (hot) section, the engine is overheating. Stop the vehicle as soon as safely possible, switch off the engine immediately and let the engine cool. Refer to *Engine coolant* in the *Maintenance and care* chapter.

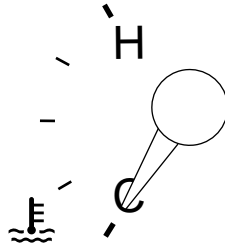

Never remove the coolant reservoir cap while the engine is running or hot.

This gauge indicates the temperature of the engine coolant, not the coolant level. If the coolant is not at its proper level the gauge indication will not be accurate. If the gauge enters the “H” (hot) section, the oil pressure, engine coolant and *Check Engine/Service Engine Soon* indicators illuminate, refer to *What you should know about fail-safe cooling* in the *Maintenance and care* chapter.

# Instrumentation

## Tachometer

Indicates the engine speed in revolutions per minute.

Driving with your tachometer pointer continuously at the top of the scale may damage the engine.

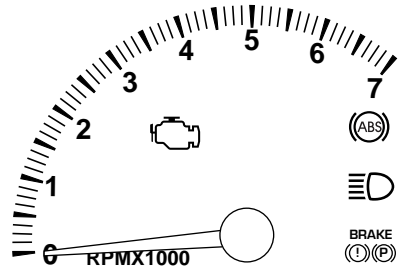

## Speedometer

Indicates the current vehicle speed.

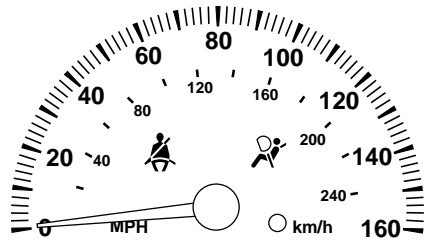

## Fuel gauge

Displays approximately how much fuel is in the fuel tank (when the key is in the RUN position). The fuel gauge may vary slightly when the vehicle is in motion. The ignition should be in the OFF position while the vehicle is being refueled. When the gauge first indicates empty, there is a small amount of reserve fuel in the tank. When refueling the vehicle from empty indication, the amount of fuel that can be added will be less than the advertised capacity due to the reserve fuel.

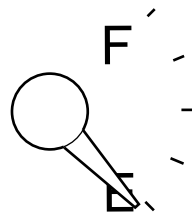



## Odometer

Registers the total kilometers (miles) of the vehicle.



## Trip odometer

Registers the kilometers (miles) of individual journeys. To reset, depress the control.

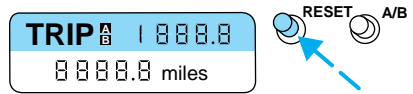

To switch the display from Trip A to the Trip B feature, depress the A/B control.

## MESSAGE CENTER (IF EQUIPPED)

With the ignition in the RUN position, the message center, located on your instrument cluster, displays important vehicle information by monitoring vehicle systems. When you change displays, a brief indicator chime will sound. The system will also notify you of potential vehicle problems with a system warnings display followed by a long indicator chime.

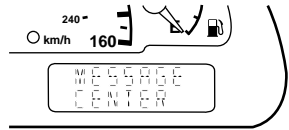

## Operator Selectable features

These features are controlled by the message center controls located above the radio.

### FUEL

Press this control for the following displays:

- Distance to Empty
- Average Fuel Economy
- Display On/Off



### RESET

Press this control to select and reset functions shown in the FUEL, SETUP and STATUS controls.

# Instrumentation

## SETUP

Press this control for the following displays:

- Language
- Units (English/Metric)
- Autolocks
- Easy Entry/Exit (if equipped)
- Lock Chirp (if equipped)

## STATUS

Selecting this function from the STATUS control causes the message center to cycle through each of the systems being monitored. For each of the monitored systems, the message center will indicate either an OK message or a warning message for four seconds.

The sequence of the status check report is as follows:

- oil life in XX%
- AC (cabin) filter XX%
- charging system
- engine temperature
- brake fluid level
- washer fluid level
- doors closed (driver and passenger side, front and rear). This message can only be reset by closing the door(s). If the RESET control is pressed, PLEASE CLOSE DOOR will be displayed.
- trunk status
- exterior lamps (front and rear turn, brake, tail and side repeater lamp (if equipped) status)
- Traction Control™ or AdvanceTrac™ (if equipped)

## Message center functions

### *Dist To Empty (DTE)*

Selecting this function from the FUEL control will give you an estimate of how far you can drive with the remaining fuel in your tank

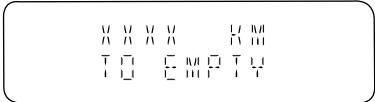

X X X X X M  
T Q E M P T U

under normal driving conditions. Remember to turn the ignition OFF when refueling your vehicle. Otherwise, the display will not show the addition of fuel for a few kilometers (miles).

The DTE function will display LOW FUEL LEVEL and sound a tone for one second when you have 80 km (50 miles) to empty. This tone will sound every 10 minutes until you refuel.

### **Fuel Econ Avg**

Select this function from the FUEL control to display your average fuel economy in liters/100 km or miles/gallon.

A rectangular digital display with a black border. The text is arranged in two lines: the top line shows 'X.X.X AVERAGE' and the bottom line shows 'L / 100 KM'. The characters are in a simple, blocky font.

If you calculate your average fuel economy by dividing liters of fuel used by 100 kilometers traveled (miles traveled by gallons used), your figure may be different than displayed for the following reasons:

- your vehicle was not perfectly level during fill-up
- differences in the automatic shut-off points on the fuel pumps at service stations
- variations in top-off procedure from one fill-up to another
- rounding of the displayed values to the nearest 0.1 liter (gallon)

### **Checking your highway fuel economy using the electronic message center display**

The following procedure will allow you to accurately monitor your actual highway fuel economy. Since this procedure requires the vehicle speed control system to be set to highway speeds, it must be run only on suitable roadways where long distance speed control can be safely maintained.

You may notice gradual improvement in fuel economy over the course of your vehicle's break-in period (approximately 1 600 kilometers [1 000 miles]).

1. Press the FUEL control to display miles to empty. Press again to display average fuel economy.

A rectangular digital display with a black border. The text is arranged in two lines: the top line shows 'AVERAGE FUEL' and the bottom line shows 'ECONOMY'. The characters are in a simple, blocky font.

2. Set the speed control. Refer to *Speed control* in the *Controls and features* chapter.

## Instrumentation

3. Press the RESET control to clear the system memory.

- *Actual highway fuel economy is now displayed.* This current average measure will change as the speed control system changes the engine speed to maintain a constant vehicle speed. This is most noticeable in hilly environments.

4. Drive the vehicle at least 8 km (5 miles) with the speed control system engaged to display a stabilized average.

5. Record the highway fuel economy for future reference.

It is important to press the RESET control after setting the speed control to get accurate highway fuel economy readings.

### **Display On/Off**

Select this function from the FUEL control to turn your message center display OFF or ON.

### **Language**

1. Select this function from the SETUP control for the current language to be displayed.

ENGLISH  
RESET FOR NEW

2. Pressing the RESET control cycles the message center through each of the language choices.

FOR ENGLISH  
HOLD RESET

3. Press and hold the RESET control to set the language choice.

SET TO  
ENGLISH

### **Units (English/Metric)**

1. Select this function from the SETUP control for the current units to be displayed.

UNITS  
ENG > METRIC

2. Press the RESET control to change from English to Metric.

### **Autolocks**

1. Select this function from the SETUP control for the current display mode.
2. Press the RESET control to turn the autolocks ON or OFF.

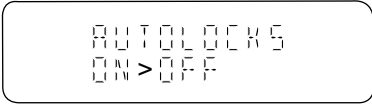

AUTOLOCKS  
ON > OFF

### **Easy entry/exit (if equipped)**

1. Select this function from the SETUP control for the current display mode.
2. Press the RESET control to turn the easy entry/exit ON or OFF.

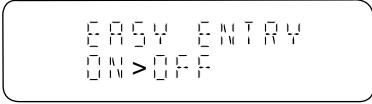

EASY ENTRY  
ON > OFF

### **Lock chirp (if equipped)**

1. Select this function from the SETUP control for the current display mode.
2. Press the RESET control to turn the lock chirp ON or OFF.

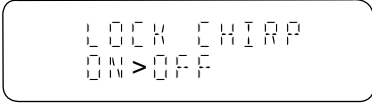

LOCK CHIRP  
ON > OFF

### **System warnings**

System warnings alert you to possible problems or malfunctions in your vehicle's operating systems.

In the event of a multiple warning situation, the message center will cycle the display to show all warnings by displaying each one for 4 seconds.

The message center will display the last selected feature if there are no more warning messages. This allows you to use the full functionality of the message center after you acknowledge the warning by pressing the RESET control and clearing the warning message.

Warning messages that have been reset are divided into two categories:

- They will reappear on the display ten minutes from the reset.
- They will not reappear until an ignition OFF-RUN cycle has been completed.

This acts as a reminder that these warning conditions still exist within the vehicle.

## Instrumentation

Warnings	Status
Engine power reduced	Warning cannot be reset
Pull off road safely	
Turn off ignition	
Driver's door ajar	
Passenger door ajar	
Driver rear door ajar	
Passenger rear door ajar	
Check engine temp	Warning returns after 10 minutes
Check charging system	
Transmission overheated	
Check transmission	
Low fuel level	
Check fuel cap	Warning returns after the ignition key is turned from OFF to RUN
Low brake fluid level	
Check tail lamps	
Check brake lamps	
Check front turn lamps	
Check side repeater lamps (if equipped)	
Check rear turn lamps	
Check Traction Control (if equipped)	
Check AdvanceTrac (if equipped)	
Trunk ajar	
Low washer fluid	
Check AC (cabin) filter	
Change oil soon	
Oil change required	
Data error	

**ENGINE POWER REDUCED.** Displayed when the engine is overheating. Stop the vehicle as soon as safely possible and turn off the engine. If this warning stays on, contact your dealer as soon as possible.

**PULL OFF ROAD SAFELY.** Displayed when the engine is overheating. Stop the vehicle as soon as safely possible and turn off the engine. If this warning stays on, contact your dealer as soon as possible.

**TURN OFF IGNITION.** Displayed when the engine is overheating. Turn off the engine. If this warning stays on, contact your dealer as soon as possible.

**DRIVER'S DOOR AJAR.** Displayed when the driver's door is not completely closed.

**PASSENGER DOOR AJAR.** Displayed when the passenger side door is not completely closed.

**DRIVER'S REAR DOOR AJAR.** Displayed when the driver's rear door is not completely closed.

**PASSENGER REAR DOOR AJAR.** Displayed when the passenger side rear door is not completely closed.

**CHECK ENGINE TEMP.** Displayed when the engine coolant is overheating. Stop the vehicle as soon as safely possible, turn off the engine and let it cool. Check the coolant and coolant level. Refer to *Engine coolant* in the *Maintenance and care* chapter. If the warning stays on or continues to come on, contact your dealer as soon as possible.

**CHECK CHARGING SYSTEM.** Displayed when the electrical system is not maintaining proper voltage. If you are operating electrical accessories when the engine is idling at a low speed, turn off as many of the electrical loads as soon as possible. If the warning stays on or comes on when the engine is operating at normal speeds, have the electrical system checked as soon as possible.

**TRANSMISSION OVERHEATED.** Indicates the transmission is overheating. This warning may appear when towing heavy loads or when driving in a low gear at a high speed for an extended period of time. Stop the vehicle as soon as safely possible, turn off the engine and let it cool. Check the transmission fluid and level. Refer to *Transmission fluid* in the *Maintenance and care* chapter. If the warning stays on or continues to come on, contact your dealer for transmission service as soon as possible.

**CHECK TRANSMISSION.** Indicates the transmission is not operating properly. If this warning stays on, contact your dealer as soon as possible.

**LOW FUEL LEVEL.** Displayed when you have approximately 80 km (50 miles) to empty.

## Instrumentation

**CHECK FUEL CAP.** Displayed when the fuel filler cap is not properly installed. Check the fuel filler cap for proper installation. Refer to *Fuel Filler Cap* in the *Maintenance and care* chapter.

**LOW BRAKE FLUID.** Indicates the brake fluid level is low and the brake system should be inspected immediately. Refer to *Checking and adding brake fluid* in the *Maintenance and care* chapter.

**CHECK TAIL LAMPS.** Displayed when the tail lamps are activated and at least one is burned out. Check the lamps as soon as safely possible and have the burned out lamp replaced.

**CHECK BRAKE LAMPS.** Displayed when the brake lamps are activated and at least one is burned out. Check the lamps as soon as safely possible and have the burned out lamp replaced. The center high-mount brakelamp is not monitored.

**CHECK FRT TURN LAMPS.** Displayed when the turn signals are activated and at least one is burned out. Check the lamps as soon as safely possible and have the burned out lamp replaced.

**CHECK SIDE REPEATER LAMPS (if equipped).** Displayed when the turn signals are activated and at least one is burned out. Check the lamps as soon as possible and have the burned out lamp replaced.

**CHECK REAR TURN LAMPS.** Displayed when the turn signals are activated and at least one is burned out. Check the lamps as soon as possible and have the burned out lamp replaced.

**CHECK TRACTION CONTROL (if equipped).** Displayed when the Traction Control™ system is not operating properly. If this message is displayed on the message center **and** the amber T/C OFF light in the Traction Control™ on/off switch is **not** illuminated, the Traction Control™ system will be partially operable. If this warning stays on, contact your dealer for service as soon as possible. For further information, refer to *Traction control™* in the *Driving* chapter.

**CHECK ADVANCETRAC (if equipped).** Displayed when the AdvanceTrac™ system is not operating properly. If this message is displayed on the message center the AdvanceTrac™ system will be partially operable. If this warning stays on while the engine is running, contact your dealer for service as soon as possible. For further information, refer to *AdvanceTrac™ stability enhancement system* in the *Driving* chapter.

**TRUNK AJAR.** Displayed when the trunk is not completely closed.



**LOW WASHER FLUID.** Indicates the washer fluid reservoir is less than one quarter full. Check the washer fluid level. Refer to *Checking and adding washer fluid* in the *Maintenance and care* chapter.

**CHECK AC (cabin) FILTER.** Displayed when the A/C cabin filter life remaining is 5 percent or less. When A/C Filter life left is between 5% and 0%, the CHANGE A/C FILTER SOON message will be displayed. When A/C Filter life left reaches 0%, the AC FILTER CHANGE REQUIRED message will be displayed.

To reset the A/C Filter monitoring system to 100% after each A/C Filter change:

1. Press the STATUS control to access the System Check function, the message center will display A/C FILTER XXX% RESET FOR NEW.

```
AC FILTER XX%  
RESET FOR NEW
```

2. Press and hold the RESET control to set to 100%, the message center will display IF NEW FILTER HOLD RESET.

```
IF NEW FILTER  
HOLD RESET
```

3. After a successful reset, the message center will display A/C FILTER LIFE SET TO 100%.

```
AC FILTER LIFE  
SET TO XX%
```

**CHANGE OIL SOON/OIL CHANGE REQUIRED.** Displayed when the engine oil life remaining is 5 percent or less. When oil life left is between 5% and 0%, the CHANGE OIL SOON message will be displayed. When oil life left reaches 0%, the OIL CHANGE REQUIRED message will be displayed.

An oil change is required whenever indicated by the message center. USE ONLY RECOMMENDED ENGINE OILS.

To reset the oil monitoring system to 100% after each oil change [approximately 8 000 km (5 000 miles) or 180 days] perform the following:

1. Press the STATUS control to access the System Check function. Press RESET to reset oil %.

```
OIL LIFE XX%  
RESET FOR NEW
```

## Instrumentation

2. Press and hold the RESET control to set to 100%.

IF NEW OIL  
HOLD RESET

3. After a successful reset, the message center will display OIL LIFE SET TO 100%.

OIL LIFE SET  
TO XX%

To reset the oil monitoring system to your personalized oil life %:

1. Press the STATUS control to access the System Check function. Press RESET to reset oil %.

OIL LIFE XX%  
RESET FOR NEW

2. Press RESET and SETUP controls at the same time to activate a service mode which will display OIL LIFE XX% RESET TO ALTER.

OIL LIFE XX%  
RESET TO ALTER

3. Press RESET until you find your personalized OIL LIFE XX%.

OIL LIFE SET  
TO XX%

**DATA ERROR.** These messages indicate improper operation of the vehicle network communication between electronic modules.

- Fuel computer
- Engine sensor
- Gear selection
- Door sensor
- Trunk sensor
- Exterior lamps
- Traction Control™ and AdvanceTrac™ (if equipped)

Contact your dealer as soon as possible if these messages occur on a regular basis.

## Controls and features

### HEADLAMP CONTROL

Rotate the headlamp control to the first position to turn on the parking lamps. Rotate to the second position to also turn on the headlamps.

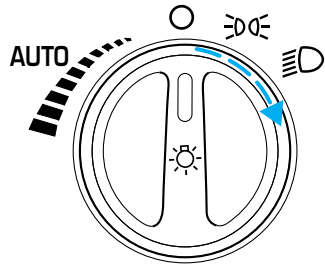

### Daytime running lamps (DRL) (if equipped)

Turns the highbeam headlamps on with a reduced output.

To activate with automatic transmission:

- the ignition must be in the RUN position;
- the headlamp control is in the OFF position, Parking lamps position, or Autolamp position when the autolamp function has not turned on the headlamps (daytime); and
- the transmission is out of Park.

To activate with manual transmission:

- the ignition must be in the RUN position;
- the headlamp control is in the OFF position, Parking lamps position, or Autolamp position when the autolamp function has not turned on the headlamps (daytime); and
- the parking brake is released.



Always remember to turn on your headlamps at dusk or during inclement weather. The Daytime Running Light (DRL) System does not activate your tail lamps and generally may not provide adequate lighting during these conditions. Failure to activate your headlamps under these conditions may result in a collision.

## Controls and features

### High beams

Pull toward you until control stops to activate. Control will return to original position. Repeat to deactivate.

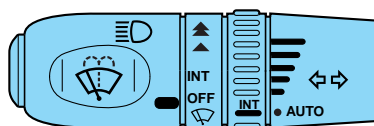

### Flash to pass

Pull toward you to activate and release to deactivate.

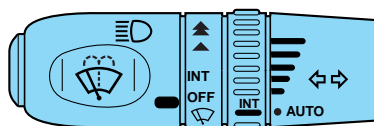

### Foglamp control

The headlamp control also operates the foglamps. The foglamps can be turned on when the headlamp control is in any of the following positions:

- Parking lamps
- Low beams
- Autolamps

Pull headlamp control towards you to turn foglamps on. The foglamp indicator light will illuminate.

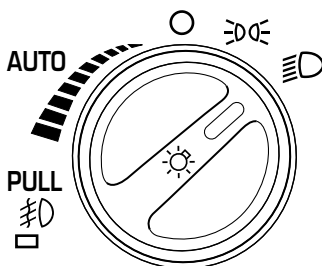

## Controls and features

### AUTOLAMP CONTROL

The autolamp system provides light sensitive automatic on-off control of the exterior lights normally controlled by the headlamp control.

The autolamp system also keeps the lights on for a preselected period of time after the ignition switch is turned to OFF.

- To turn autolamps on, rotate the control counterclockwise. The preselected time lapse is adjustable up to approximately three minutes by continuing to rotate the control counterclockwise.
- To turn autolamps off, rotate the control clockwise to OFF.

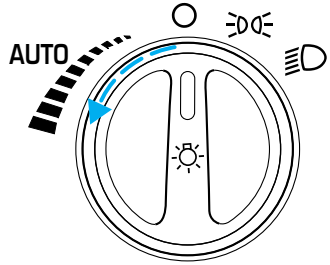

### PANEL DIMMER CONTROL

Use to adjust the brightness of the instrument panel during parklamp, headlamp, and autolamp operation.

- Rotate up to brighten.
- Rotate down to dim.
- Rotate fully up to turn on the interior lights.

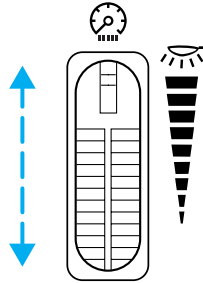

### POWER SIDE VIEW MIRRORS

The power mirrors can be operated at any time.

To adjust your mirrors:

1. Select L to adjust the left mirror or R to adjust the right mirror.

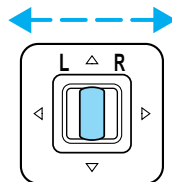

## Controls and features

2. Move the control in the direction you wish to tilt the mirror.

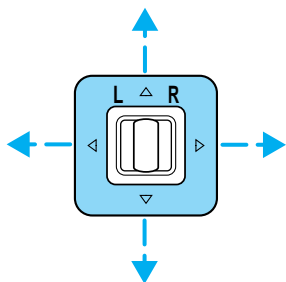

3. Return to the center position to lock mirrors in place.

### Heated outside mirrors

Both mirrors are heated automatically to remove ice, mist and fog when the rear window defrost is activated.

Do not remove ice from the mirrors with a scraper or attempt to readjust the mirror glass if it is frozen in place. These actions could cause damage to the glass and mirrors.

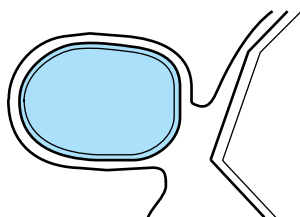

### TRUNK REMOTE CONTROL

Press the remote trunk release control on the instrument panel to open the trunk.

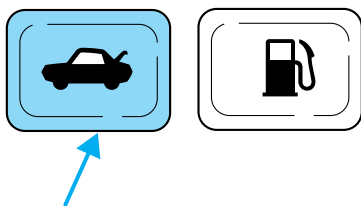

## Controls and features

### FUEL DOOR RELEASE

Press the remote fuel door release control on the instrument panel to open the fuel door.

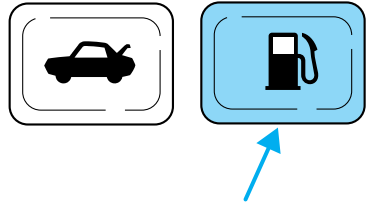

The fuel door has a manual override release located in the trunk. Pull the tab to open the fuel door.

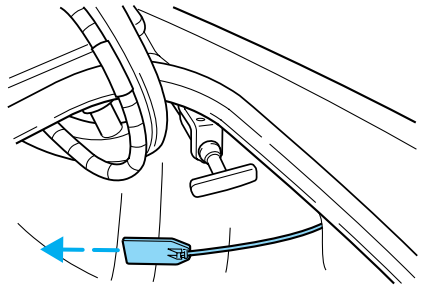

### CLIMATE CONTROL SYSTEM

#### Dual Automatic Temperature Control (DATC) system

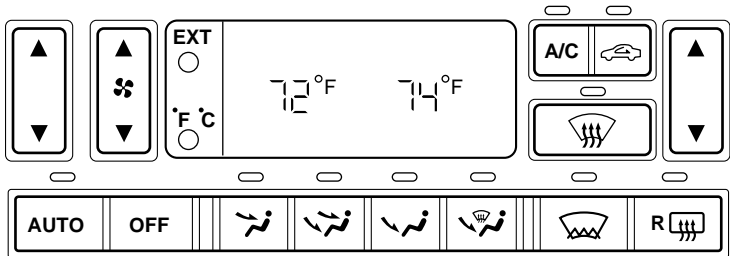

The Dual Automatic Temperature Control (DATC) system will maintain a selected temperature and automatically control air flow.

You can override the automatic operation with any of the override controls.

The dual temperature zone feature allows the driver and front passenger to set their own independent temperature set points for individual comfort. The system uses common controls for air distribution and fan speed for both driver and passenger.

## Controls and features

### Turning the DATC system on

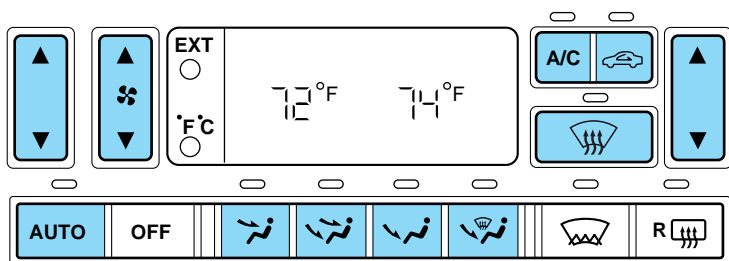

Press AUTO, any of the override controls, the fan speed control, or either of the temperature selection controls. The DATC system will only operate when the ignition is in the RUN position.

### Turning the DATC system off

Press OFF. The outside temperature (EXT) function (if selected) will continue to operate until the ignition is turned off.

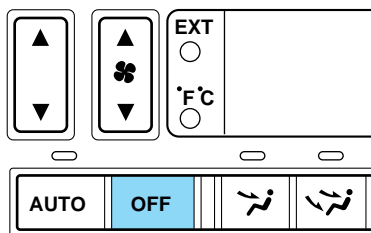

### DATC automatic operation

Press AUTO and select the desired temperature. The selected temperature will appear in the display window, and an indicator above the AUTO control will light. The DATC system will either heat or cool the vehicle to achieve the selected temperature. The system will automatically determine the fan speed, airflow location and whether outside or recirculated air is required.

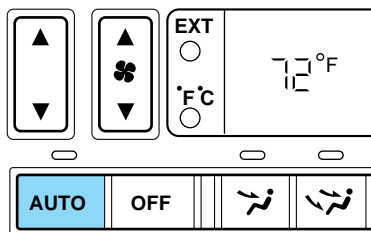

When in AUTO and weather conditions require heat, the DATC directs the majority of the airflow to the floor area. The system will allow some airflow out the defroster and demister outlets and outer instrument panel registers in order to reduce window fogging. Additionally, if the



## Controls and features

engine is not warm enough to provide heat, the fan will operate at a low speed and the airflow will be directed to the windshield or to the floor. In 3½ minutes or less, the fan speed will start to increase and the airflow location will change to the floor area.

When in AUTO mode, the DATC system automatically controls the air conditioning operation, the fan speed, the airflow direction and determines whether outside or recirculated air is required. Manual control of the A/C, air recirculation and fan speed are available in auto mode.

If unusual conditions exist (i.e.-window fogging, etc.), the manual override controls allow you to select airflow locations as necessary. To return to full automatic control, press the AUTO control.

### DATC system AUTO temperature balance

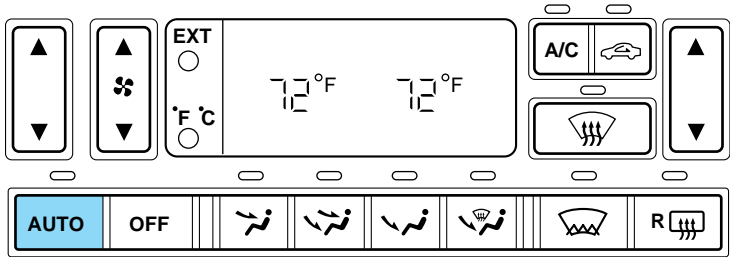

Press and hold the AUTO control for about two seconds to equalize the passenger set temperature with the driver side temperature. This feature is useful when the driver is alone in the vehicle.

### Driver side temperature selection

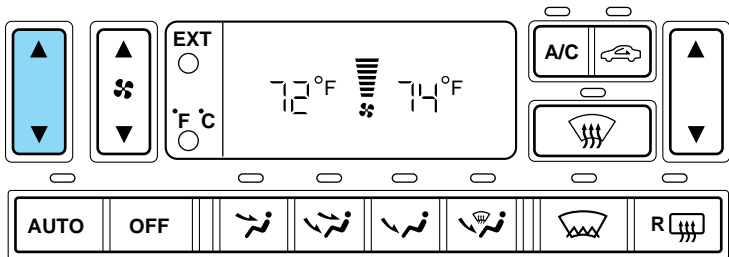

The display window indicates the selected temperature and manual control of fan speed (  ) if automatic fan speed is not desired.

## Controls and features

To control the temperature, select any temperature between 19°C (65°F) and 29°C (85°F) by pressing the temperature control on the driver side of the system.

For continuous maximum cooling, press the temperature control until 16°C (60°F) is shown in the display window. The DATC will continue maximum cooling (disregarding the displayed temperature) until a warmer temperature is selected by pressing the temperature control. If maximum cooling is selected, the passenger set point is not displayed and the passenger temperature adjustments will be disabled.

For continuous maximum heating, press the temperature control until 32°C (90°F) is shown in the display window. The DATC will continue maximum heating (disregarding the displayed temperature) until a cooler temperature is selected by pressing the temperature control. If maximum heating is selected, the passenger set point is not displayed and the passenger temperature adjustments will be disabled.

A change of the driver-selected temperature to a temperature other than 16°C (60°F) or 32°C (90°F) will display the passenger set point. The passenger side set point will increase or decrease along with the driver side temperature set point until a change is made using the passenger temperature control.

### ***Passenger side temperature selection***

To control the temperature, select any temperature between 19°C (65°F) and 29°C (85°F) by pressing the temperature control on the passenger side of the system.

If the driver side temperature selection is set for maximum cooling (16°C (60°F)) or maximum heating (32°C (90°F)), the passenger side temperature adjustments will be disabled and the passenger set point will not be displayed.

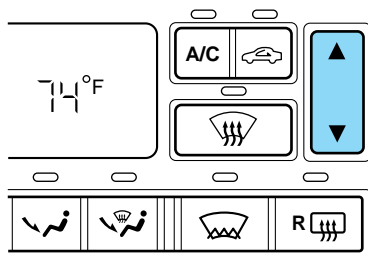

## Controls and features

### Temperature conversion

Press the Fahrenheit/Celsius (°F °C) control to switch between Fahrenheit and Celsius temperature on the DATC display only. The set point temperatures in Celsius will be displayed in half-degree increments.

The English/Metric control on the trip computer and message center (if equipped) will not change the DATC temperature display.

Refer to *Electronic Message Center* in the *Instrumentation* chapter.

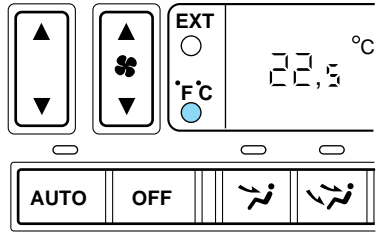

### Fan speed ( )

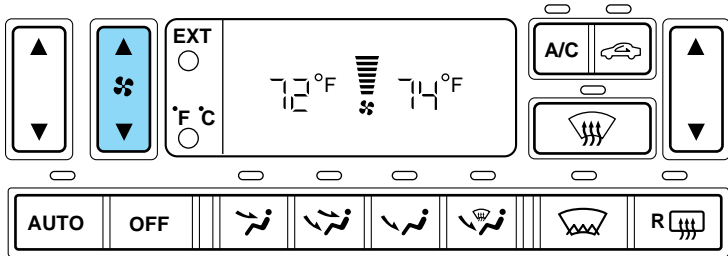

When AUTO is pressed, fan speed is adjusted automatically for existing conditions. You can override fan speed at any time. To control fan speed manually, press the fan control to cancel the automatic fan speed operation. Press the control up for higher fan speed or down for lower fan speed. The display will show  and a bar graph to indicate manual fan speed operation and relative speed.

When the fan is adjusted in the AUTO mode, the AUTO indicator will remain lit and the system will remain in auto operation.

To return to automatic fan operation, press AUTO. The fan icon and bars will disappear from the display, and the DATC system will return to full automatic operation.

## Controls and features

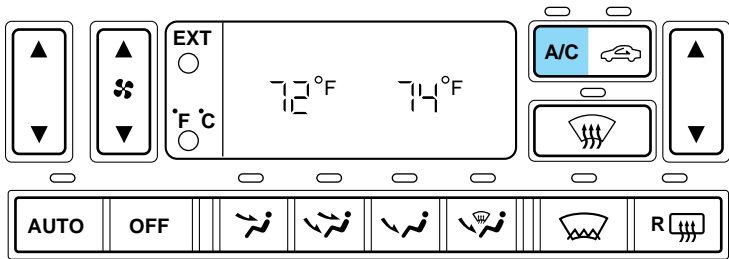

### • A/C control

 (air conditioning) — Used to manually enable or disable the operation of the air conditioning in all modes except defrost. In all modes, the air conditioning will only function if the outside temperature is about 2°C (35°F) or higher. When manual A/C is selected (ON) the indicator will be lit. When manual A/C is selected (OFF) the indicator will not be lit.

In defrost mode, if the outside temperature is about 2°C (35°F) or higher, the air conditioner will automatically dehumidify the air to reduce window fogging. However, the A/C indicator will be off and the A/C override control cannot be selected.

When AUTO is selected, the A/C operates automatically for existing conditions. With automatic A/C operation, the A/C indicator will be lit if the outside temperature is about 2°C (35°F) or higher. You may override the automatic A/C operation at any time. To manually control the A/C operation and cancel automatic A/C operation, press the A/C control. When the A/C is manually controlled in the AUTO mode, the AUTO indicator will remain lit. To return to automatic A/C operation, press AUTO.

## Controls and features

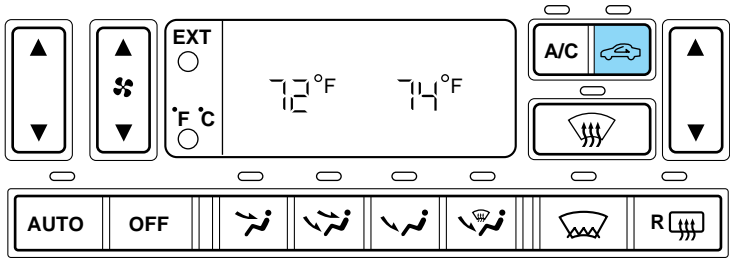

### • Recirculation control

 (air recirculation) — Used to manually enable or disable the operation of the recirculated air operation in all modes except defrost. The use of recirculated air when the air conditioning is operating helps to reduce the amount of time to cool down the interior of the vehicle in very hot conditions. Recirculated air may also help to keep undesired outside odors from reaching the vehicle interior. It is recommended to allow the DATC system to automatically control the selection of outside or recirculated air.

The recirculation control cannot be selected in the defrost mode, as interior fogging may occur.

In floor and floor/defrost modes, the DATC system will automatically return to outside air to help reduce window fogging. When the recirculation air control is selected, the amount of time in manual recirculated air depends on the ambient temperature.

When AUTO is selected, the recirculated air feature operates automatically for existing conditions. You may override the automatic recirculated air operation at any time. To manually control the recirculated air operation and cancel automatic recirculated air operation, press the recirculated air control. When the recirculated air is manually controlled in the AUTO mode, the AUTO indicator light will remain lit. To return to full automatic recirculated air operation, press AUTO.

Do not leave the DATC system in recirculated air operation for extended periods of time while the system is in a heating mode or in cold/damp conditions as this may cause interior fogging of the front, side and rear windows.

## Controls and features

### Manual override controls

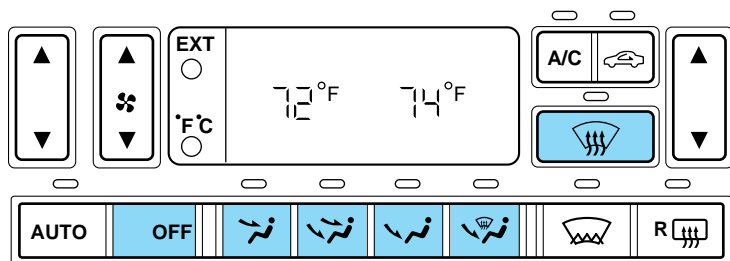

The manual override controls allow you to manually determine where airflow is directed. To return to fully automatic control, press AUTO.

When a manual airflow override control is selected, the DATC system will turn off the AUTO indicator and display the indicators of all operating override controls. More than one override control indicator may turn on when an override control is selected.

The air conditioning compressor can operate in all modes except OFF. However, the air conditioning will only function if the outside temperature is about 2°C (35°F) or higher.

Since the air conditioner removes considerable moisture from the air during operation, it is normal if clear water drips on the ground under the air conditioner drain while the system is working and even after you have stopped the vehicle.

#### • Airflow direction control

 (panel) — Distributes air through the instrument panel and center console registers.

 (panel/floor) — Distributes air through the instrument panel and center console registers, and the front and rear seat floor ducts. For added customer comfort, the air distributed through the floor ducts may be slightly warmer than the air sent to the instrument panel registers.

 (floor) — Distributes air through the front and rear seat floor ducts. The system will allow some airflow out the defroster ducts, the demister outlets and outer instrument panel registers.

 (floor/defrost) — Distributes air through the windshield defroster ducts, the demister outlets and the front and rear seat floor ducts. The system will allow some airflow out the outer instrument panel registers.

## Controls and features

When floor/defrost is selected, if the outside temperature is about 2°C (35°F) or higher, the air conditioner will automatically dehumidify the air to reduce window fogging. For added customer comfort, the air distributed through the floor ducts may be slightly warmer than the air sent to the windshield defroster ducts. When floor/defrost is selected, the system will automatically provide outside air to reduce window fogging. Recirculation and A/C override controls can be selected.

 (defrost) — Distributes outside air through the windshield defroster ducts and the demister outlets. It can be used to clear ice or fog from the windshield. The system will allow some airflow out the outer instrument panel registers. If the outside temperature is about 2°C (35°F) or higher, the air conditioner will automatically dehumidify the air to reduce window fogging. (Note that the A/C indicator does not illuminate when this mode is selected.) Recirculation and A/C override controls cannot be selected.

### • Turn DATC off

OFF-Outside air is shut out. The fan, heating and air conditioning will not operate. The outside temperature will still display when selected with the ignition in the RUN position.

### **Electric window heaters**

 (heated wiper rest) — Located at the base of the windshield, this feature heats the front glass area below the area heated by the front defroster where the windshield wipers sit in their parked position. When activated, the feature keeps the wiper blades warm and reduces the chance of ice build up on the blades. The indicator will light when the feature is in operation.

With the ignition in RUN and the engine running, the feature will be automatically enabled if the temperature is below 5°C (40°F). The feature can be manually selected or deselected at any time. However, the automatic feature will be enabled each time the engine is started.

In cold, dry conditions where wet snow or ice is not present it is acceptable to manually deselect the operation of this feature.

The feature will run continuously unless a low battery condition is detected, or unless the feature is manually deselected, and will only activate when the vehicle engine is running (to prevent excessive drain of the vehicle battery).

 (rear window defroster) — Refer to *Rear Window Defroster*.

## Controls and features

### Displaying outside temperature

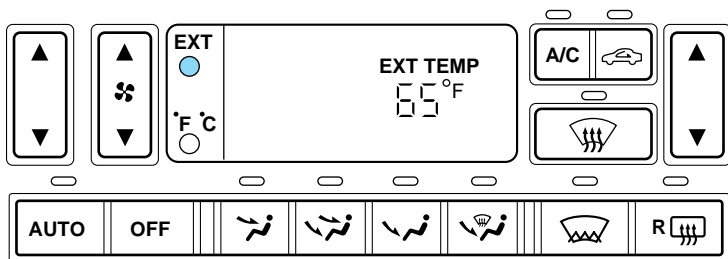



Press EXT to display the outside air temperature. It will remain selected until the EXT control is pressed again.

If the driver or passenger temperature or the fan speed is changed, or the AUTO or  modes selected while the outside temperature is displayed, the driver and passenger temperature display will be displayed for 4 seconds. Following this, the outside temperature display will return to the window.

If the outside temperature is displayed while the DATC system is in the OFF mode and the DATC is turned on, the driver and passenger temperatures will be displayed for 4 seconds. Following this, the outside temperature display will return to the window.

The outside temperature reading is most accurate when the vehicle is moving. Higher readings may be obtained when the vehicle is not moving. The readings may not agree with temperatures given on the radio due to differences in vehicle and station locations.

### Operating tips

- In humid weather, select  and **R**  before driving. This will reduce fogging on your windshield. After a few minutes, select any desired position.
- To prevent humidity buildup inside the vehicle, don't drive with the climate control system in the OFF position.
- DO NOT leave the DATC system in recirculated air mode for extended periods of time while the system is in a heating mode or in cold or damp conditions as this may cause interior fogging of the front, side and rear windows.
- Do not place objects under the front seat that will interfere with the airflow to the rear seats.



## Controls and features

- Remove any snow, ice or leaves from the air intake area at the base of the windshield.

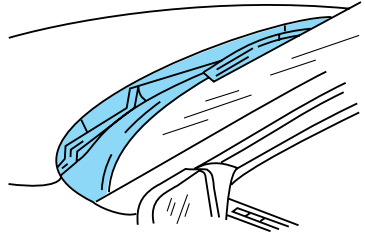

- If your vehicle has been parked with the windows closed during hot weather, the air conditioner will do a much faster job of cooling if you drive for two or three minutes with the windows open. This will force most of the hot, stale air out of the vehicle. Then operate the air conditioner as you would normally.
- If the air conditioner works well with the recirculation feature on, but not in the outside air mode, this may indicate that the cabin air filter needs to be replaced.
- Do not place objects over the defroster outlets. These objects can block airflow and reduce your ability to see through your windshield. Also, avoid placing small objects on top of your instrument panel. These objects can fall down into the defroster outlets and block airflow and possibly damage your climate control system.

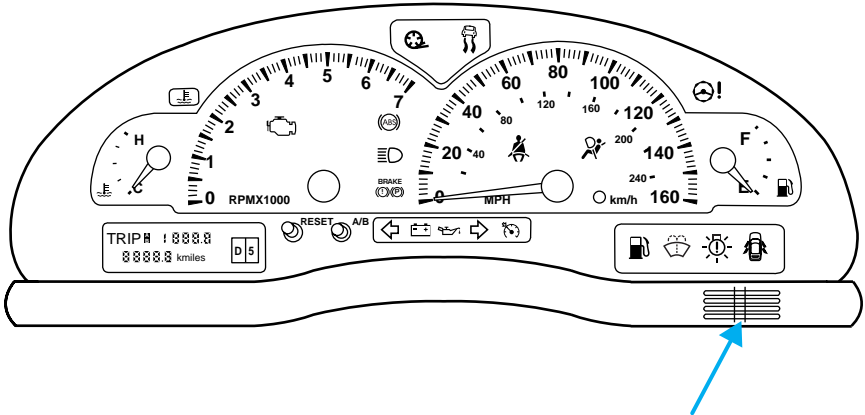

- Do not place items over the climate temperature sensor grid. This may cause improper operation of the DATC system.

## Controls and features

- With the ignition in the OFF position after operating the vehicle, some vehicle sounds related to the climate control system may be heard.
- Approximately two minutes after key off, the air distribution doors may adjust their positions as part of the normal operating process.

To aid in side window defogging:

1. Select 
2. Set the temperature control to full heat
3. Select A/C
4. Set the fan speed to High
5. Direct the outer panel vents towards the side windows
6. In order to increase the airflow to the outer panel vents, close the central panel vents.



Do not place objects on top of the instrument panel, as these objects may become projectiles in a collision or sudden stop.

### REAR WINDOW DEFROSTER

Press the rear window defroster control to clear the rear window and sideview mirrors of thin ice or fog. The indicator will illuminate when the rear window defroster is selected.

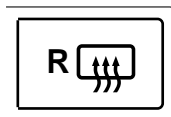

The ignition must be in the RUN position and the engine running in order to operate the rear window defroster.

The rear window defroster turns off automatically after 10 minutes or sooner if a low battery condition is detected, or when the ignition is turned to the OFF position. To manually turn off the rear window defroster before 10 minutes have passed, push the control again.

### USING YOUR AUDIO SYSTEM

Your audio system is equipped with selective lighting, a unique lighting strategy. This lighting feature is operable when the headlamps are illuminated. During the operation of any selected mode, lighting for the individual function controls will either illuminate or turn off. Those controls which have a function for the specific mode of operation selected will be lit, while the controls which have no function for that mode will be turned off.

# Controls and features

## Premium AM/FM Stereo/Cassette

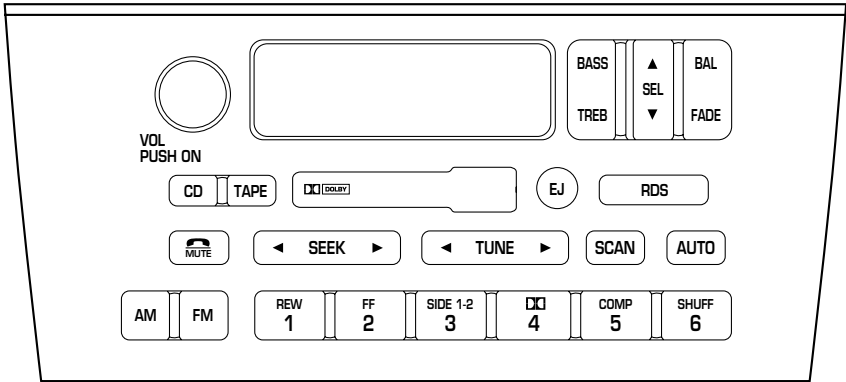

## Alpine Audio System with AM/FM Stereo/Cassette

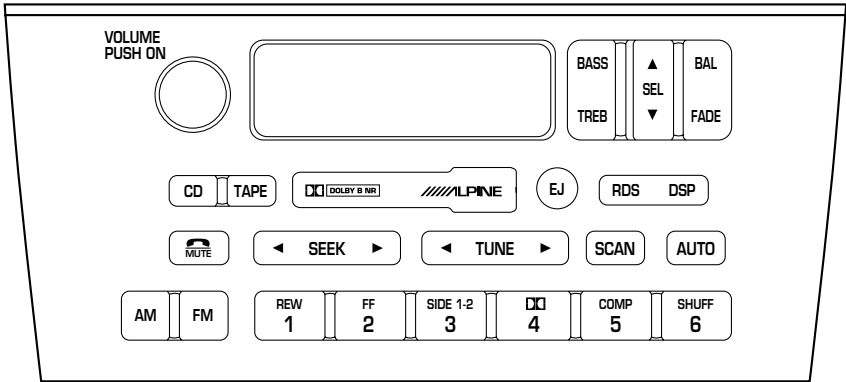

### Volume/power control

Press the control to turn the audio system on or off.

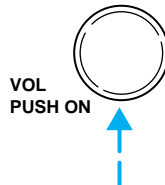

## Controls and features

Turn the control to raise or lower volume.

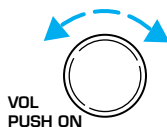

If the volume is set above a certain level and the ignition is turned off, the volume will come back on at a “nominal” listening level when the ignition switch is turned back on.

### **Speed sensitive volume**

With this feature, radio volume changes automatically and slightly with vehicle speed to compensate for road and wind noise.

The recommended level for speed sensitive volume is from level 1 through level 3. Level 0 turns the speed sensitive volume off and level 7 is the maximum setting.

With the radio on, press and hold the volume control for five seconds, then press:

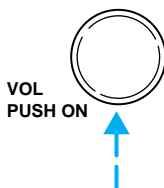

- ▲ to increase volume compensation
- ▼ to decrease or shut off the volume compensation

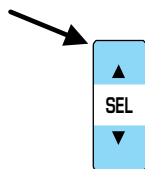

### **AM/FM select**

The AM/FM select control works in radio, tape and CD modes (if equipped).

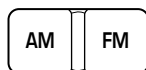

### **AM/FM select in radio mode**

This control allows you to select AM or FM frequency bands. Press the control to switch between AM, FM1 or FM2 memory preset stations.

## Controls and features

### **AM/FM select in tape mode**

Press this control to stop tape play and begin radio play.

### **AM/FM select in CD mode (if equipped)**

Press this control to stop CD play and begin radio play.

### **Tune adjust**

The tune control works in radio or CD mode (if equipped).

#### **Tune adjust in radio mode**

- Press ◀ to move to the next frequency down the band (whether or not a listenable station is located there). Hold the control to move through the frequencies quickly.
- Press ▶ to move to the next frequency up the band (whether or not a listenable station is located there). Hold for quick movement.

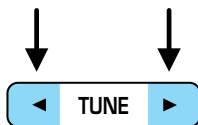

#### **Tune adjust for CD changer (if equipped)**

- Press ◀ to select the previous disc in the CD changer. (Play will begin on the first track of the disc unless the CD changer is in shuffle mode.) Refer to *Shuffle feature* for more information. Hold the control to continue reversing through the disc.
- Press ▶ to select the next disc in the CD changer. Hold the control to fast-forward through the remaining discs.

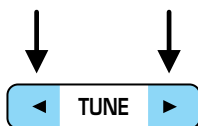

### **Seek function**

The seek function control works in radio, tape or CD mode (if equipped).

#### **Seek function in radio mode**

- Press ◀ to find the next listenable station down the frequency band.
- Press ▶ to find the next listenable station up the frequency band.



## Controls and features

### **Seek function in tape mode**

- Press ◀ to listen to the previous selection on the tape or return to the beginning of the current selection.
- Press ▶ to listen to the next selection on the tape.

### **Seek function for CD changer (if equipped)**

- Press ◀ to seek to the previous track of the current disc. If a selection has been playing for three seconds or more and you press ◀, the CD changer will replay that selection from the beginning.
- Press ▶ to seek forward to the next track of the current disc. After the last track has been completed, the first track of the current disc will automatically replay.



### **Scan function**

The scan function works in radio, tape or CD mode (if equipped).

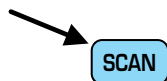

### **Scan function in radio mode**

Press the SCAN control to hear a brief sampling of all listenable stations on the frequency band. Press the SCAN control again to stop the scan mode.

### **Scan function in tape mode**

Press the SCAN control to hear a short sampling of all selections on the tape. (The tape scans in a forward direction. At the end of the tape's first side, direction automatically reverses to the opposite side of the tape.) To stop on a particular selection, press the control again.

### **Scan function in CD mode (if equipped)**

Press the SCAN control to hear a short sampling of all selections on the CD. (The CD scans in a forward direction, wrapping back to the first track at the end of the CD.) To stop on a particular selection, press the control again.

### **Radio station memory preset**

The radio is equipped with six station memory preset controls. These controls can be used to select up to six preset AM stations and twelve FM stations (six in FM1 and six in FM2).

### **Setting memory preset stations**

1. Select the frequency band with the AM/FM select control.
2. Select a station. Refer to *Tune adjust* or *Seek function* for more information on selecting a station.
3. Press and hold a memory preset control until the sound returns, indicating the station is held in memory on the control you selected.

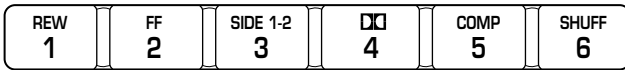

### **Autoset memory preset**

Autoset allows you to set strong radio stations without losing your original manually set preset stations. This feature is helpful on trips when you travel between cities with different radio stations.

### **Starting autoset memory preset**

1. Select a frequency using the AM/FM select controls.
2. Press the control.
3. When the first six strong stations are filled, the station stored in memory preset control 1 will start playing.



If there are less than six strong stations available on the frequency band, the remaining memory preset controls will all store the last strong station available.

To deactivate autoset and return to your audio system's manually set memory stations, press the control again.

## Controls and features

### **Bass adjust**

The bass adjust control allows you to increase or decrease the audio system's bass output.

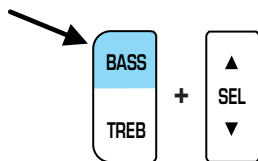

### **Treble adjust**

The treble adjust control allows you to increase or decrease the audio system's treble output.

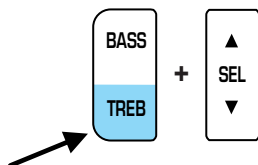

### **Speaker balance adjust**

Speaker sound distribution can be adjusted between the right and left speakers.

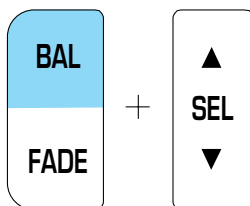

### **Speaker fade adjust**

Speaker sound can be adjusted between the front and rear speakers.

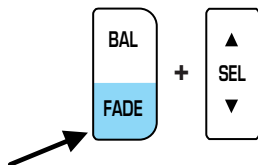

### **Tape/CD select**

- To begin tape play (with a tape loaded into the audio system) while in the radio or CD mode, press the TAPE control. Press the button during rewind or fast forward to stop the rewind or fast forward function.





## Controls and features

- To begin CD play (if CD[s] are loaded), press the CD control. The first track of the disc will begin playing. After that, CD play will begin where it stopped last.

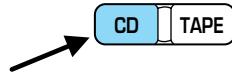

### **Rewind**

The rewind control works in tape and CD modes.

- In tape mode, radio play will continue until rewind is stopped (with the TAPE control) or the beginning of the tape is reached.
- In CD mode, pressing the REW control for less than three seconds results in slow rewind. Pressing the control for more than three seconds results in fast rewind.



### **Fast forward**

The fast forward control works in tape and CD modes (if equipped).

- In the tape mode, tape direction will automatically reverse when the end of the tape is reached.
- In CD mode, pressing the control for less than three seconds results in slow forward action. Pressing the control for more than three seconds results in fast forward action.



### **Tape direction select**

Press SIDE 1-2 to play the alternate side of a tape.

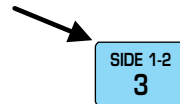

### **Eject function**

Press the control to stop and eject a tape.

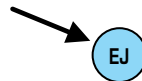

## Controls and features

### **Dolby® noise reduction**

Dolby® noise reduction operates only in tape mode. Dolby® reduces the amount of hiss and static during tape playback.

Press the  control to activate (and deactivate) Dolby® noise reduction.

Dolby® noise reduction is manufactured under license from Dolby Laboratories Licensing Corporation. “Dolby®” and the double-D symbol are trademarks of Dolby Laboratories Licensing Corporation.

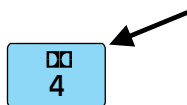

### **Compression feature**

Compression adjust brings soft and loud CD passages together for a more consistent listening level.

Press the COMP control to activate and deactivate compression adjust.

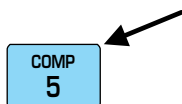

### **Shuffle feature**

The shuffle feature operates in CD mode and plays all tracks on the current disc in random order. If equipped with the CD changer, the shuffle feature continues to the next disc after all tracks are played.

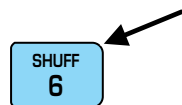

Press the SHUFFLE control to start this feature. Random order play will continue until the SHUFFLE control is pressed again.



### **Setting the clock with radio data system (RDS) feature**

Press the RDS control until CLOCK HOUR or CLOCK MINUTE is displayed.

Use the SEL control to manually set the time.

- Press  to increase hours/minutes.
- Press  to decrease hours/minutes.

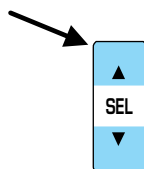

## Controls and features

### **Radio data system (RDS) feature**

This feature allows your audio system to receive text information from RDS-equipped FM radio stations.

Press the RDS control until the display reads RDS OFF. Press the SEL control to engage this feature (RDS ON). Once the RDS feature is on, press the RDS control to scroll through the following selections:



#### **Traffic**

- Press the RDS control until TRAFFIC is displayed.
- Use the SEL control to select ON or OFF. With the feature on, use the SEEK or SCAN control to find a radio station broadcasting a traffic report (if it is broadcasting RDS data).

Traffic information is not available in most US markets.

#### **Program type**

- Press the RDS control until FIND program type is displayed.
- Use the SEL control to select the program type. With the feature on, use the SEEK or SCAN control to find the desired program type from the following selections:
  - Classic
  - Country
  - Info
  - Jazz
  - Oldies

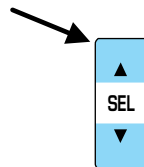
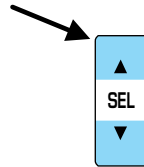

## Controls and features

- R & B
- Religious
- Rock
- Soft
- Top 40

### Show

- With RDS activated, press the RDS control until SHOW is displayed.
- Use the SEL control to select TYPE, NAME or NONE.

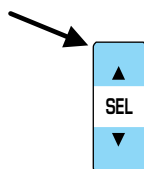

### Phone/mute mode

This feature allows you to control the factory-installed cellular phone (if equipped) through the radio controls.

- Press the phone/mute control to enter phone mode.
- Use SEEK or radio presets 1 through 6 to select a phone number.
- Press the phone/mute control again to send and end calls.

Press the control again to return to the playing media.

This control will mute the playing media even if your vehicle is not equipped with a factory-installed cellular phone.



### Digital signal processing (if equipped)

The digital signal processing (DSP) feature allows you to change the signal mode to suit your listening tastes.

Press the control to turn the feature on or off.



## Controls and features

Use the SEL control to select the desired signal mode (the selected mode will appear in the display). The following signal modes can be selected:

- JAZZ CLUB—jazz club with clearly reflected sounds
- HALL—rectangular concert hall capacity of about 2 000
- CHURCH—church with a high vault
- STADIUM—outdoor stadium with a capacity of about 30 000
- NEWS—“voice-only” type of sound with a limited audio band

Press the DSP control until one of the following appears:

- ALL SEATS
- DRIVER SEAT
- REAR SEATS

Use the SELECT control to change the equalization to the desired mode.

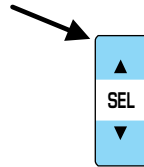
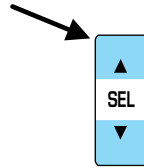

## Controls and features

Alpine Audiophile AM/FM Stereo In-Dash Six CD Radio  
Alpine Sport Audio AM/FM Stereo In-Dash Six CD Radio  
Premium Alpine Audio AM/FM Stereo In-Dash Six CD Radio

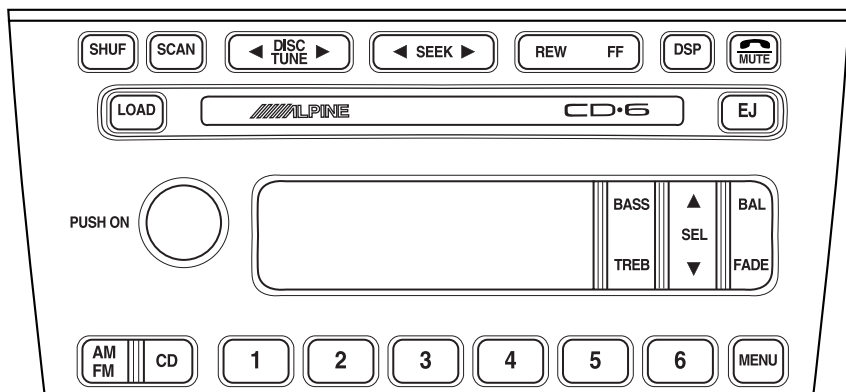

### *Premium AM/FM Stereo In Dash Six CD Radio*

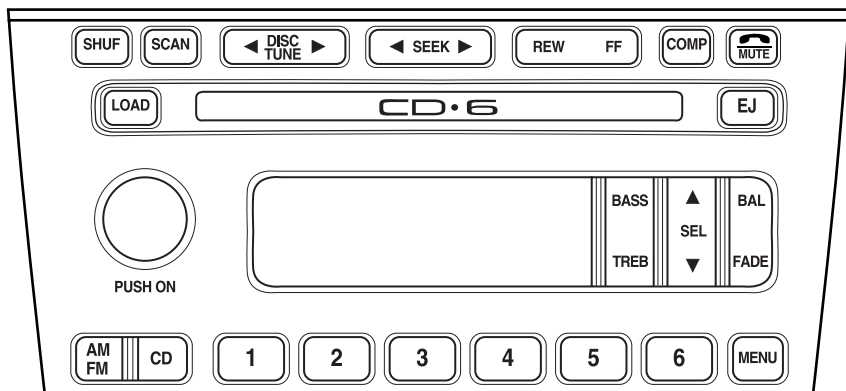

## Controls and features

### ***Volume/power control***

Press the control to turn the audio system on or off.

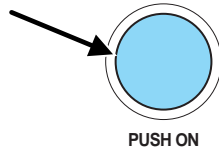

Turn the control to raise or lower volume.

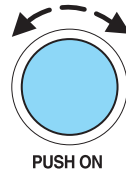

If the volume is set above a certain level and the ignition is turned off, the volume will come back on at a “nominal” listening level when the ignition switch is turned back on.

### ***AM/FM select***

The AM/FM select control works in radio and CD modes.

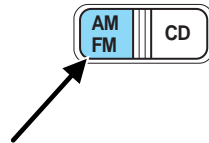

### ***AM/FM select in radio mode***

This control allows you to select AM or FM frequency bands. Press the control to switch between AM, FM1 or FM2 memory preset stations.

### ***AM/FM select in CD mode***

Press this control to stop CD play and begin radio play.

### ***Tune adjust***

The tune control works in radio or CD mode.

## Controls and features

### **Tune adjust in radio mode**

- Press ◀ to move to the next frequency down the band (whether or not a listenable station is located there). Hold the control to move through the frequencies quickly.
- Press ▶ to move to the next frequency up the band (whether or not a listenable station is located there). Hold for quick movement.

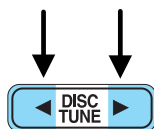

### **Tune adjust for CD mode**

- Press ◀ to select the previous disc. (Play will begin on the first track of the disc unless shuffle mode is engaged.) Refer to *Shuffle feature* for more information. Hold the control to continue reversing through the discs.
- Press ▶ to select the next disc. Hold the control to fast-forward through the remaining discs.

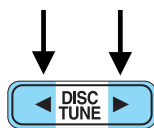

### **Seek function**

The seek function works in radio or CD mode.

#### **Seek function in radio mode**

- Press ◀ to find the next listenable station down the frequency band. SEEK DOWN will display.
- Press ▶ to find the next listenable station up the frequency band. SEEK UP will display.



#### **Seek function in CD mode**

- Press ◀ to seek to the previous track of the current disc. If the beginning of the disc is reached, the CD player seeks to the beginning of the last track on the current disc and begins playing.
- Press ▶ to seek forward to the next track of the current disc. After the last track has been completed, the first track of the current disc will automatically replay.





## Controls and features

### **Scan function**

The scan function works in radio or CD mode.

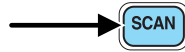

### **Scan function in radio mode**

Press the SCAN control to hear a brief sampling of all listenable stations on the frequency band. Press the SCAN control again to stop the scan mode.

### **Scan function in CD mode**

Press the SCAN control to hear a short sampling of all selections on the CD. (The CD scans in a forward direction, wrapping back to the first track at the end of the CD.) To stop on a particular selection, press the control again.

### **Radio station memory preset**

The radio is equipped with six station memory preset controls. These controls can be used to select up to six preset AM stations and twelve FM stations (six in FM1 and six in FM2).

### **Setting memory preset stations**

1. Select the frequency band with the AM/FM select control. Press the AM/FM control to toggle between AM, FM1, or FM2.
2. Press the SEEK control to access the next listenable station up or down the frequency band. Press the TUNE control to go up or down the listening band in individual increments.
3. Select a station. Refer to *Seek function* for more information on selecting a station.
4. Press and hold a memory preset control. The playing media will mute momentarily. When the sound returns, the station is held in memory on the control you selected. The display will read **SAVED**.

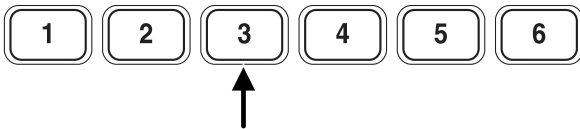

## Controls and features

### **Autostore**

Autostore allows you to set the strongest local radio stations without losing your original manually set preset stations. This feature is helpful on trips when you travel between cities with different radio stations.

### **Starting autostore**

1. Press and momentarily hold the AM/FM control.
2. AUTOSET will flash in the display as the frequency band is scrolled through.
3. When the six strongest stations are filled, the station stored in memory preset control 1 will start playing.

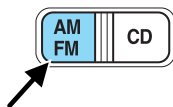

If there are less than six strong stations available on the frequency band, the remaining memory preset controls will all store the last strong station available.

To deactivate autostore and return to your audio system's manually set memory stations, press the AM/FM control again.

### **CD select**

CD mode may be entered by pressing the CD control and the LOAD control. Load the CD into the audio system. The first track of the disc will begin playing. After that, CD play will begin where it stopped last.



If an alternative CD is desired, press the corresponding preset control (1–6) of a loaded CD, or press the TUNE control to access the other loaded CDs.

NO CD will display if the CD control is activated when there is not a CD present in the audio system.

If the CD control is pressed followed by with a preset number and that particular slot is empty, NO CD will display and the system will begin the play the next available disc.

**Do not insert any promotional (odd shaped or sized) discs, or discs with removable labels into the CD player as jamming may occur.**

### **Display description**

Six circles are always lit in the digital display. These signify the six CD slots in the audio system. When a disc is loaded into a particular slot (1–6), the number inside that specific circle lights. If the circle is empty, there is no CD in that particular slot.

### **Load**

The load feature allows you to load single CDs into the player internal to the radio.



**This six disc CD player is equipped with a CD door. Compact discs should only be inserted into the player after the door has been opened by the player. Do not attempt to force the door open. Compact discs should only be loaded by pressing the LOAD control.**

Press the LOAD control. (You can choose which slot will be loaded by pressing the desired preset number. If you do not choose a slot, the system will choose the next available one.) Wait until the CD door opens. Load the CD into the player. LOADING CD# is displayed. When the CD has been loaded, the door will close and the CD will begin to play. For example, to load a CD into slot #2, press the LOAD control and then press preset #2.

### **Auto load**

This feature allows you to autoload up to 6 discs into the multi disc CD player internal to the radio.



Press and hold the LOAD control until AUTOLOAD # is displayed. The CD door will open. Load the desired disc, one at a time. The CD is loaded into position and the audio system will display CD#. Each time the CD door opens, INSERT CD# is displayed. The door will close and the player will move to the next slot after each disc has been loaded. The process is repeated until all 6 slots are full. The audio system plays the last CD loaded and the display is updated. If some slots are already full and autoload is activated, the system will fill all empty slots.

## Controls and features

### **Eject**

Press the EJ control to stop and eject a CD. You can choose which CD will be ejected by pressing the EJ control and the desired preset number (1–6). For example, to eject CD#2, press the EJ control and then press the preset #2 control. If you do not choose a specific CD, the player will eject the current CD.



If a CD is ejected and not removed from the door of the CD player, the player will automatically reload the CD. This feature may be used when the ignition is ON or OFF.

### **Auto eject**

Press and momentarily hold the EJ control to engage auto eject. All CDs which are present in the player will be ejected one at a time. If a CD is ejected and not removed from the door of the CD player, the player will automatically reload the CD. This feature may be used when the ignition is ON or OFF.



### **Rewind**

The rewind control works in CD modes.

Press and hold the REW control until the desired selection is reached. If the beginning of the disc is reached, the CD will begin play at the first track. Release the control to disengage rewind mode.

When in rewind mode, your audio system will automatically lower the volume level of the playing media.



### **Fast forward**

The fast forward control works in CD modes.

Press and hold the FF control until the desired selection is reached. If the end of the disc is reached, the CD will return to the first track on the first disc. Release the control to disengage fast forward mode.

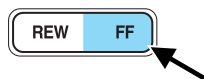

## Controls and features

When in fast forward mode, your audio system will automatically lower the volume level of the playing media.

### **Shuffle feature**

Press the SHUF control until the desired shuffle mode is displayed. The audio system will then engage the desired shuffle mode.



When engaged, the shuffle feature has two different modes: SHUFFLE DISC and SHUFFLE TRK.

SHUFFLE DISC randomly plays tracks from all the discs presently in the audio system.

SHUFFLE TRK plays all the tracks on the current disc in random order.

### **Compression feature**

The compression feature operates in CD mode and brings soft and loud CD passages together for a more consistent listening level.

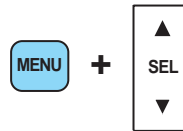

On Audiophile audios, press the MENU control until compression status is displayed. Press the SEL control to enable the compression feature when COMP OFF is displayed. Press the SEL control again to disable the feature when COMP ON is displayed.

On Premium audios, press the COMP control until COMP ON is displayed.



### **Bass adjust**

The bass adjust control allows you to increase or decrease the audio system's bass output.

Press the BASS control. Use the SEL control to increase or decrease the amount of bass.



## Controls and features

### Treble adjust

The treble adjust control allows you to increase or decrease the audio system's treble output.

Press the TREB control. Use the SEL control to increase or decrease the amount of treble.



### Speaker balance adjust

Speaker sound distribution can be adjusted between the right and left speakers.

Press the BAL control. Use the SEL control to adjust the sound between the speakers.

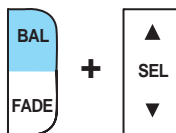

### Speaker fade adjust

Speaker sound can be adjusted between the front and rear speakers.

Press the FADE control. Use the SEL control to adjust the sound between the front and rear speakers.

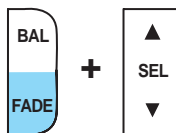

### Menu mode

The MENU control allows you to access many different features within your audio system. There are three sets of menus available depending upon which mode or feature is activated.

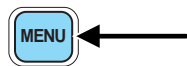

While in FM mode, two menus are available. If RDS is turned off, you can access the following:

- SELECT HOURS — Refer to *Setting the clock*.
- SELECT MINUTES — Refer to *Setting the clock*.
- RDS OFF — Refer to *Radio data system*.

If RDS is turned on, you can access the following:

- TRAFFIC ON/OFF-Refer to *Traffic announcements*.
- FIND type-Refer to *Radio data system*.

## Controls and features

- SHOW (NAME, TYPE, NONE)—Refer to *Radio data system*.
- RDS ON— Refer to *Radio data system*.
- SELECT HOURS — Refer to *Setting the clock*.
- SELECT MINUTES —Refer to *Setting the clock*.

When in CD mode, you can access: SELECT HOURS, SELECT MINUTES or COMP ON/OFF.

SELECT HOURS, SELECT MINUTES— Allows you to adjust the hours and minutes. Refer to *Setting the clock*.

TRAFFIC ON/OFF— Traffic announcements can be programmed as local or distant. Refer to *Traffic announcements*.

RDS ON/OFF— This feature allows your audio system to receive text information from RDS-equipped FM radio stations. Refer to *RDS feature*.

FIND type — Allows you to select your desired FM program type and search for that selection.

SHOW — Allows you to select from NAME (displays the name of the radio station), TYPE (displays the RDS program type: rock, jazz, etc.), or NONE (deactivates the RDS display).

### **Radio data system (RDS) feature**

This feature allows your audio system to receive text information from RDS-equipped FM radio stations.

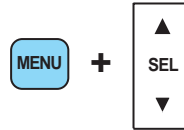

#### **To activate RDS:**

- When in FM mode, press the MENU control until RDS OFF displays.
- Press the SEL control to engage this feature (RDS ON).

#### **RDS features:**

Once the RDS feature is on, press the MENU control to scroll through the following selections:

#### **Traffic announcements**

This feature allows you to hear traffic announcements while in CD mode. These announcements are broadcast by traffic capable RDS stations.

## Controls and features

When in this mode, traffic announcements will interrupt radio and CD play.

- Press the MENU control until TRAFFIC is displayed.
- Press the SEL control to engage the feature. The display will read TRAFFIC ON.

This feature also allows you to control the volume of traffic announcements. With the display reading TRAFFIC ON, adjust the volume using the volume control to the desired level. The volume level will show at the bottom of the display. Interrupting traffic announcements will be at the selected volume level.

To disengage the feature, press the MENU control until TRAFFIC ON displays. Press the SEL control. The display will read TRAFFIC OFF.

**Traffic announcements not available in most U.S. markets.**

### ***Program type***

This feature allows you to search for RDS stations selectively by their program type.

Press the MENU control until FIND program type is displayed.

Use the SEL control to select the program type. With the feature on, use the SEEK or SCAN control to

find the desired program type from the following selections:

- Classic
- Country
- Info
- Jazz
- Oldies
- R & B
- Religious
- Rock
- Soft
- Top 40

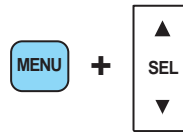



## Controls and features

### Show

This feature allows you to select the type of RDS broadcast information the radio will regularly show in the display.

With RDS activated, press the MENU control until SHOW is displayed.

Use the SEL control to select TYPE (displays the RDS program type: rock, jazz, etc), NAME (displays the name of the radio station) or NONE (deactivates the RDS display).

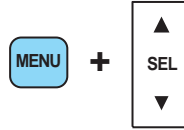
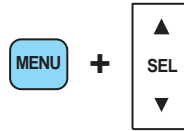

### Digital signal processing (if equipped)

The digital signal processing (DSP) feature allows you to change the signal mode to suit your listening tastes.

Press the DSP control to access the DSP menu. Press the SEL control to enter one of the following modes:

- DSP OFF
- SIGNAL MODE
- OCCUPANCY MODE

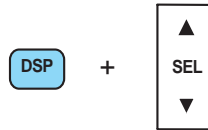

Use the SEL control to select the desired signal mode (the selected mode will appear in the display). The following signal modes can be selected:



- DSP OFF—disengages the feature
- NEWS—"voice-only" type of sound with a limited audio band
- JAZZ CLUB—jazz club with clearly reflected sounds
- HALL—rectangular concert hall capacity of about 2 000
- CHURCH—church with a high vault
- STADIUM—outdoor stadium with a capacity of about 30 000

## Controls and features

Press the DSP control again to access the occupancy modes. Use the SEL control to optimize the sound based upon the occupants in the vehicle. The following occupancy modes can be selected:

- ALL SEATS
- DRIVER SEAT
- REAR SEATS

### **Phone mode**

This feature allows you to control the factory-installed cellular phone (if equipped) through the radio controls.



- Press the phone/mute control to enter phone mode. The playing media will mute.
- Use SEEK, TUNE or radio presets 1 through 6 to select a phone number previously programmed in the phone.
- Press the phone/mute control again to send and end calls.

This control will mute the playing media even if your vehicle is not equipped with a factory-installed cellular phone.

Press the control again to return to the playing media.

### **Setting the clock**

Press the MENU control until SELECT HOUR or SELECT MINUTE is displayed.



Use the SEL control to manually set the time.

- Press ▲ to increase hours/minutes.
- Press ▼ to decrease hours/minutes.



## Controls and features

### CD changer (if equipped)

The CD changer is located in the glove compartment.

Press ▲ to eject the magazine.

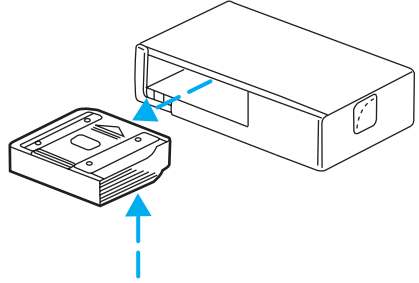

1. Pull the lever to remove a CD tray from the magazine.

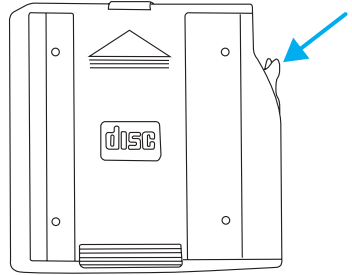

2. Insert one disc into each CD tray of the magazine (up to 6 discs). Ensure that the label side is facing up.

If you pull too hard on the disc holder, the disc holder may come completely out of the magazine. If this happens, reinsert the disc holder back into the magazine.

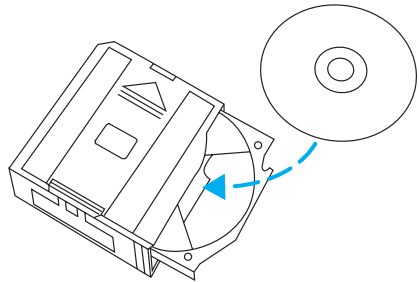

## Controls and features

3. Insert each CD tray, with the disc loaded, all the way into the CD magazine.

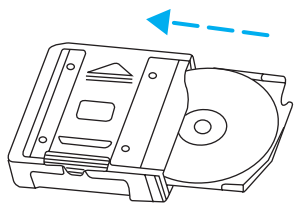

4. Insert the CD magazine into the changer.

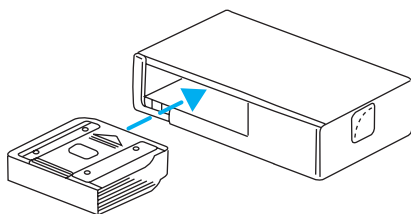

Use only compact discs containing this mark.



Ensure that the disc is inserted label side up.

The magazine does not need to be full for the changer to operate.

Radio power must be turned on to play the CDs in the changer. The magazine may be stored in the glove compartment when not being used.

The CD magazine may be inserted or ejected with the radio power off.

If coins or foreign objects get inside your system, they will damage the CD player and void your audio system warranty.

Do not insert any damaged, or visibly contaminated discs into the magazine as CD operation will be effected.

**Do not insert any promotional (odd shaped or sized) discs, or discs with removable labels into the CD player as jamming may occur.**

### Troubleshooting the CD changer (if equipped)



The laser beam used in the compact disc player is harmful to the eyes. Do not attempt to disassemble the case.

## Controls and features

If sound skips:

- You may be traveling on a rough road, playing badly scratched discs or the disc may be dirty. Skipping will not scratch the discs or damage the player.

If your changer does not work, it may be that:

- A disc is already loaded where you want to insert a disc.
- The disc is inserted with the label surface downward.
- The disc is dusty or defective.
- The player's internal temperature is above 60°C (140°F). Allow the player to cool down before operating.
- A disc with format and dimensions not within industry standards is inserted.

### Cleaning compact discs

Inspect all discs for contamination before playing. If necessary, clean discs only with an approved CD cleaner and wipe from the center out to the edge. Do not use circular motion.

### CD and CD changer care

- Handle discs by their edges only. Never touch the playing surface.
- Do not expose discs to direct sunlight or heat sources for extended periods of time.
- Do not insert more than one disc into each slot of the CD changer magazine.

**Do not insert any promotional (odd shaped or sized) discs, or discs with removable labels into the CD player as jamming may occur.**

### Cleaning cassette player (if equipped)

Clean the tape player head with a cassette cleaning cartridge after 10 to 12 hours of play in order to maintain the best sound and operation.

### Cassette and cassette player care

- Use only cassettes that are 90 minutes long or less.
- Do not expose tapes to direct sunlight, high humidity, extreme heat or extreme cold. Allow tapes that may have been exposed to extreme temperatures to reach a moderate temperature before playing.

## Controls and features

- Tighten very loose tapes by inserting a finger or pencil into the hole and turning the hub.
- Remove loose labels before inserting tapes.
- Do not leave tapes in the cassette player for a long time when not being played.

### Radio frequency information

The Federal Communications Commission (FCC) and the Canadian Radio and Telecommunications Commission (CRTC) establish the frequencies AM and FM stations may use for their broadcasts. Allowable frequencies are:

AM 530, 540–1600, 1610 kHz

FM 87.7, 87.9–107.7, 107.9 MHz

Not all frequencies are used in a given area.

### Radio reception factors

Three factors can affect radio reception:

- **Distance/strength.** The further an FM signal travels, the weaker it is. The listenable range of the average FM station is approximately 40 km (24 miles). This range can be affected by “signal modulation.” Signal modulation is a process radio stations use to increase their strength/volume relative to other stations.
- **Terrain.** Hills, mountains and tall buildings between your vehicle’s antenna and the radio station signal can cause FM reception problems. Static can be caused on AM stations by power lines, electric fences, traffic lights and thunderstorms. Moving away from an interfering structure (out of its “shadow”) returns your reception to normal.
- **Station overload.** Weak signals are sometimes captured by stronger signals when you pass a broadcast tower. A stronger signal may temporarily overtake a weaker signal and play while the weak station frequency is displayed.

The audio system automatically switches to single channel reception if it will improve the reception of a station normally received in stereo.

### Audio system warranties and service

Refer to the “Warranty Guide” for audio system warranty information.

If service is necessary, see your dealer or a qualified technician.

### REMOVAL/INSTALLATION OF ASHTRAY

Before removing and installing the ashtray, make sure the ignition is in the off position, and move the floor mounted automatic shifter from the park position.

In order to prevent damage, follow these instructions when removing/installing the ashtray.

Removal:

1. Push and release ashtray face to open.
2. Pull up on face of ashtray until ashtray releases.

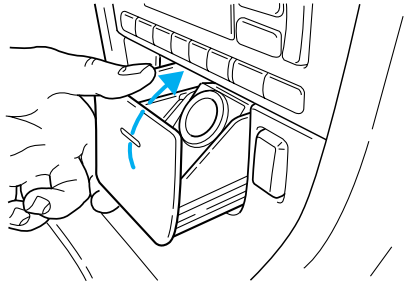

3. Pull out ashtray assembly.

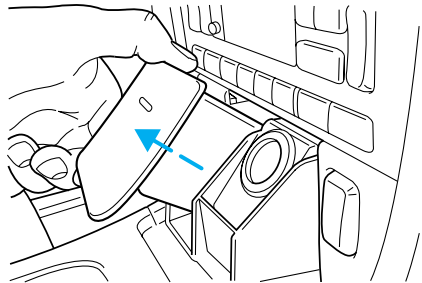

Installation:

1. Insert ashtray into opening with face tilted upward.
2. Push face down until it clicks into position.

### STEERING COLUMN LOCK (IF EQUIPPED)

The steering column will automatically lock when the key is removed from the ignition. When the vehicle key is inserted into the ignition, the steering column will automatically unlock. The steering column lock is equipped on manual transmission vehicles only.

## Controls and features

### POSITIONS OF THE IGNITION

1. LOCK, locks the gearshift lever (automatic transmission only) and allows key removal.
2. OFF, shuts off the engine and all accessories without locking the steering wheel (if equipped).
3. ACCESSORY, allows the electrical accessories such as the radio to operate while the engine is not running.
4. RUN, all electrical circuits operational. Warning lights illuminated. Key position when driving.
5. START, cranks the engine. Release the key as soon as the engine starts.

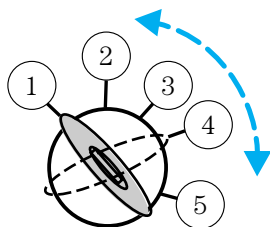

### KEYS

The vehicle is equipped with a master key; and may be equipped with a valet key lock system. The master key will actuate the driver's door, trunk, glove box and ignition. If equipped, the valet key (the key without the Lincoln logo) will actuate door and ignition only.

Refer to the *Securilock Passive Anti-Theft System* section for more information on Securilock keys.

### Valet switch (if equipped)

Before using your valet key, press the valet switch in the glove compartment to disable the Trunk remote control which is located on the instrument panel, then lock the glove compartments with your master key.

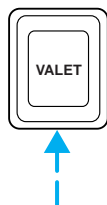



## Controls and features

### TURN SIGNAL CONTROL ⇐⇒

- Push down to activate the left turn signal.
- Push up to activate the right turn signal.

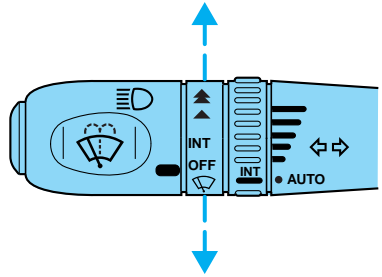

### WINDSHIELD WIPER/WASHER CONTROLS

Rotate the windshield wiper control to the desired interval, low or high speed position. The ignition must be in the ACC or RUN position to operate the windshield wiper.

The bars of varying length are for intermittent wipers. When in this position rotate the control upward for fast intervals and downward for slow intervals.

Push the control on the end of the stalk to activate washer. Push and hold for a longer wash cycle. The washer will automatically shut off after ten seconds of continuous use.

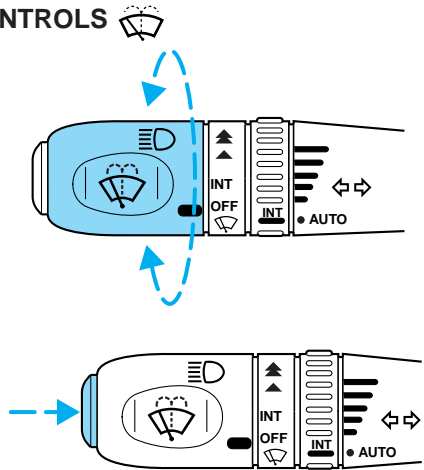

When the washer system senses low fluid in the washer bottle and the control is pushed to activate the system, washer fluid will spray onto the windshield (if the reservoir still has fluid in it), but the windshield wiper will not automatically cycle if low fluid is sensed. The wiper must be engaged by manually selecting a position on the wiper/washer control. This is to let you know that the washer fluid is low or empty and needs to be refilled. Refer to the *Windshield Washer Fluid* section of the *Maintenance and Care* chapter.

## Controls and features

### Moisture sensitive wipers (if equipped)

When the windshield wiper control is set to INT and the intermittent position is AUTO, moisture sensitive front wipers automatically activate when moisture accumulates on the windshield. When the ignition is turned to Off and then back to Run and the wiper setting has remained in AUTO position, the wipers may cycle one time.

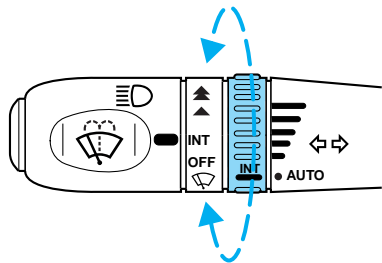

The moisture sensitive wiper feature should be turned off before entering a car wash.

### TILT/TELESCOPE STEERING COLUMN

#### Power tilt/telescope steering column



Never adjust the steering wheel when the vehicle is moving.

The steering column can be adjusted manually by moving the four-way rocker adjustment control located on the multi-function control below the turn signal/wiper control stalk. The control will adjust the column as long as held or until the column reaches the end of travel.

The telescope function is adjusted by moving the control toward the driver to telescope out and moving the control toward the instrument panel to telescope in.

The tilt function is adjusted by moving the control up to tilt up and moving the control down to tilt down.

The steering column positions are automatically saved and can be recalled along with the vehicle personality features when a memory position is selected through the remote entry transmitter or memory switch on the driver's door (if equipped with memory feature).

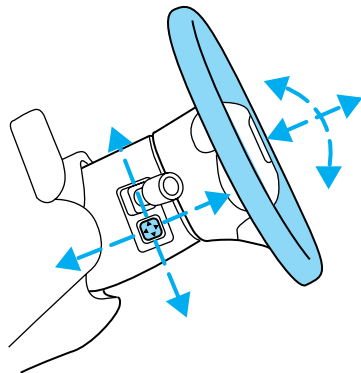

## Controls and features

During easy exit (if activated through the Message Center) operation, the column will move to the full in and up position. When the key is inserted into the ignition switch, the column will return to the previous setting. When you remove the key, the column will move away.

If the steering column adjustment control is pressed during memory recall it will cancel the automatic operation and the column will respond to manual adjustment of the control.

### STEERING WHEEL CONTROLS

These controls allow you to operate some audio control features.

#### Audio control features

Press MEDIA to select AM, FM1, FM2, TAPE, or CD (if equipped).

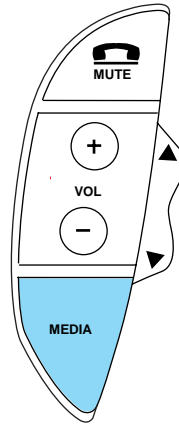

## Controls and features

### In AM, FM1, or FM2 mode:

- Press  $\Delta$  or  $\nabla$  to select preset stations within the selected radio band.

### In Tape mode:

- Press  $\Delta$  or  $\nabla$  to select the next selection on the tape.

### In CD mode:

- Press  $\Delta$  or  $\nabla$  to select the next selection on the CD.

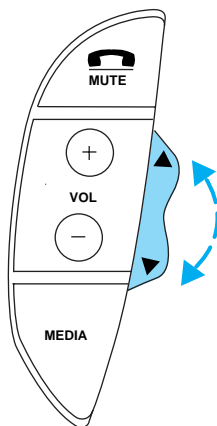

### In any mode:

- Press VOL + or - to adjust volume.

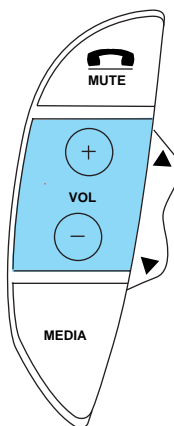

## Controls and features

Press the PHONE/MUTE control to mute the playing media. Press again to return to the playing media.

If your vehicle is equipped with a factory installed cellular phone, refer to the *Phone/Mute Mode* section of the *Controls and Features* chapter.

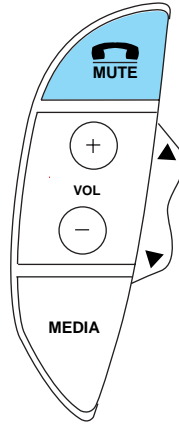

## SPEED CONTROL

### To turn speed control on

- Press ON.

Vehicle speed cannot be controlled until the vehicle is traveling at or above 48 km/h (30 mph).

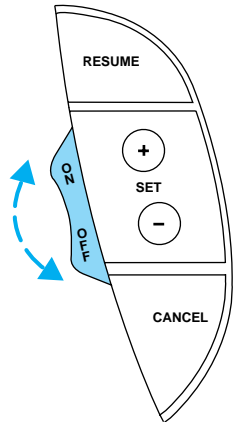

Do not use the speed control in heavy traffic or on roads that are winding, slippery, or unpaved.

## Controls and features



Do not shift the gearshift lever into N (Neutral) with the speed control on.

### To turn speed control off

- Press OFF or
- Turn off the vehicle ignition.

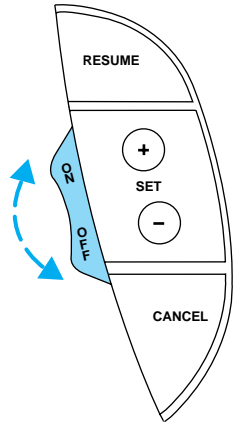

Once speed control is switched off, the previously programmed set speed will be erased.

### To set a speed

- Press SET+ / SET-. For speed control to operate, the speed control must be ON and the vehicle speed must be greater than 48 km/h (30 mph).

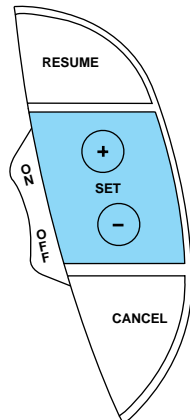

## Controls and features

If you drive up or down a steep hill, your vehicle speed may vary momentarily slower or faster than the set speed. This is normal.

Speed control cannot reduce the vehicle speed if it increases above the set speed on a downhill. If your vehicle speed is faster than the set speed while driving on a downhill, you may want to shift to the next lower gear or apply the brakes to reduce your vehicle speed.

If your vehicle slows down more than 16 km/h (10 mph) below your set speed on an uphill, your speed control will disengage. This is normal. Pressing RESUME will re-engage it.



Do not use the speed control in heavy traffic or on roads that are winding, slippery, or unpaved.

### To set a higher set speed

- Press and hold SET+. Release the control when the desired vehicle speed is reached or
- Press and release SET + to operate the Tap-Up function. Each press will increase the set speed by 1.6 km/h (1 mph) or
- Accelerate with your accelerator pedal. When the desired vehicle speed is reached, press and release SET +.

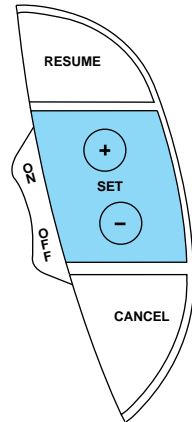

You can accelerate with the accelerator pedal at any time during speed control usage. Releasing the accelerator pedal will return your vehicle to the previously programmed set speed.

## Controls and features

### To set a lower set speed

- Press and hold SET -. Release the control when the desired speed is reached or
- Press and release SET - to operate the Tap-Down function. Each press will decrease the set speed by 1.6 km/h (1 mph) or
- Depress CANCEL or the brake pedal. When the desired vehicle speed is reached, press SET + / SET -.

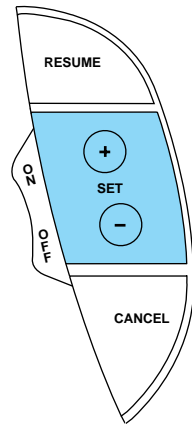
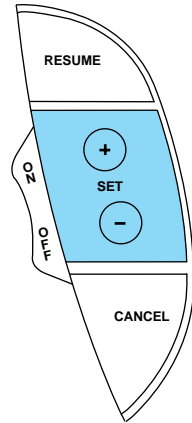



## Controls and features

### To disengage speed control

- Press CANCEL,

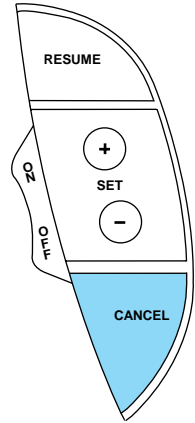

- depress the brake pedal, or

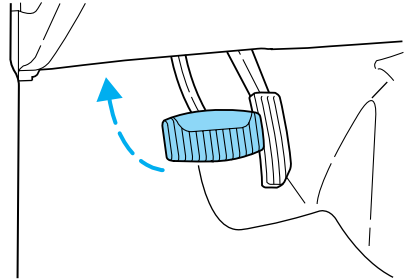

- depress the clutch pedal (if equipped).

Disengaging the speed control will not erase the previously programmed set speed.

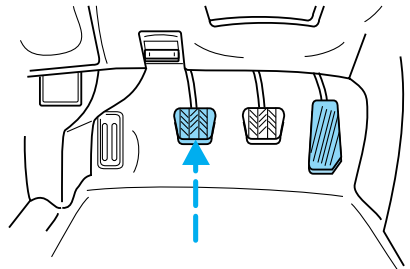

## Controls and features

Pressing OFF will erase the previously programmed set speed.

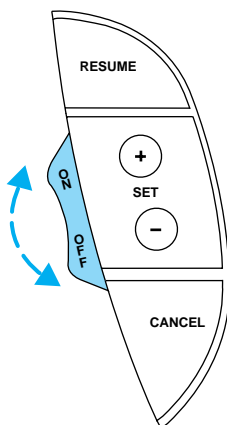

### To return to a previously set speed

- Press RESUME. For RESUME to operate, the vehicle speed must be faster than 48 km/h (30 mph).

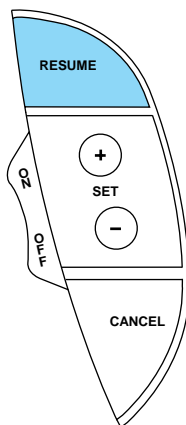

### Indicator light

This light comes on when the vehicle speed control is engaged and actively controlling vehicle speed.



## Controls and features

### MOON ROOF (IF EQUIPPED)

To open the moon roof:

- Push up on the control to raise the moon roof to the vent position (when the glass panel is closed).
- Push the front portion of the control rearward to open the moon roof.
- Press the rear portion of the control past the first detent to activate the **Auto Open** feature.

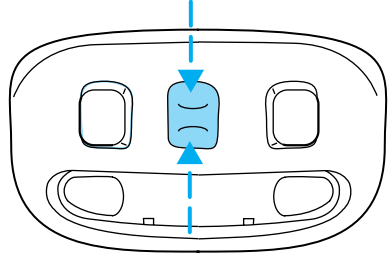

To close the moon roof:

- To close from the vent, intermediate and full open positions, push the rear portion of the control forward.

### INTERIOR LAMPS

#### Map lamps (if equipped)

The map lamps and controls are located on the dome lamp. Press the controls in front of each map lamp to activate the lamps.

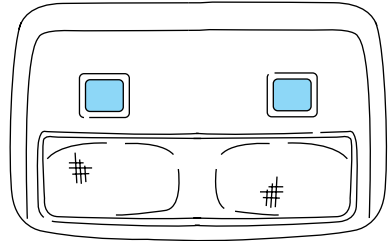

#### Rear dome lamp

The dome lamp lights when:

- any door is opened.
- the instrument panel dimmer switch is rotated up until the courtesy lamps come on.
- the remote entry UNLOCK control is pressed and the ignition is OFF.

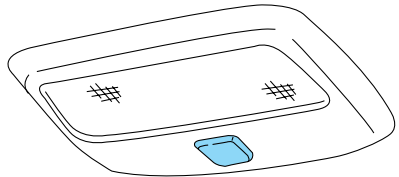

## Controls and features

With the ignition key in the OFF, ACC or RUN position, the reading lamp on the dome lamp can be turned on by pressing the control.

### **AUTOMATIC DIMMING INSIDE REAR VIEW MIRROR**

Your vehicle is equipped with an inside rear view mirror which has an auto-dimming function. The electronic day/night mirror will change from the normal state to the non-glare state when bright lights (glare) reach the mirror. When the mirror detects bright light from front or behind, it will automatically adjust (darken) to minimize glare.

Do not block the sensor on the backside of the mirror since this may impair proper mirror performance.

Ensure the mirror is pulled down low enough to prevent visibility interference with the overhead console. The mirror support arm has two pivot points which lets you adjust the mirror UP or DOWN and from SIDE to SIDE.

Press the control to turn the mirror on or off.

The mirror will automatically return to the normal state whenever the vehicle is placed in R (Reverse)(when the mirror is on) to ensure a bright clear view when backing up.

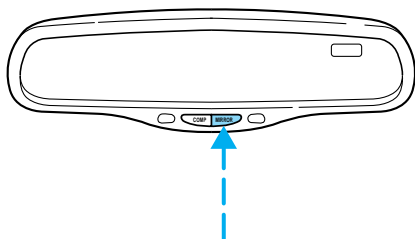

### **ELECTRONIC COMPASS (IF EQUIPPED)**

The compass reading will remain accurate during most driving conditions. Unknown to the driver, the compass is continuously recalibrating due to magnetic fields and subtle, slow changes in vehicle magnetics which can occur over the life of the vehicle.

The compass reading will remain fixed when significant levels are experienced (such as steel bridges). The compass will return to normal operation upon leaving the magnetized area.

If highly magnetized items (such as magnetic mount antennas) are placed very near the compass the display will change to “C” for 15 seconds, then display all segments until the magnetized item is removed. If a “C” is displayed, refer to *Compass calibration adjustment*.

Most geographic areas (zones) have a magnetic north compass point that varies slightly from the northerly direction on maps. This variation is four

## Controls and features

degrees between adjacent zones and will become noticeable as the vehicle crosses multiple zones. A correct zone setting will eliminate this error. Refer to *Compass zone adjustment*.

### Compass zone adjustment

1. Determine which compass zone you are in by referring to the zone map.

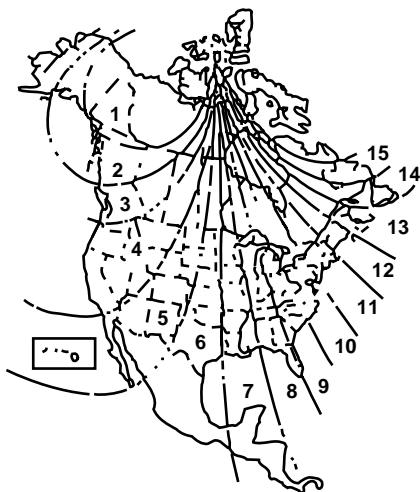

2. With the compass display turned on, press and hold the COMP side of the control for no more than six seconds until the zone selection number appears in the mirror display window. If a “C” appears repeat this step.

3. Release the COMP side of the control, then press it down again.

4. Continue to press until your zone number is shown in the mirror display, then release.

5. The display will show all segments, then return to normal compass mode within ten seconds.

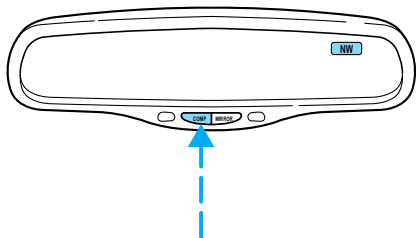

### Compass calibration adjustment

Perform this adjustment in an open area free from steel structures and high voltage lines.

## Controls and features

1. Start the vehicle.
2. Press and hold the COMP side of the control for approximately six seconds until “C” appears in the mirror display.
3. Drive the vehicle slowly (less than 5 km/h [3 mph]) in circles or on your everyday routine until the display reads a direction.
4. The compass is now calibrated.

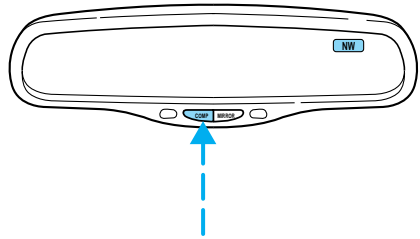

### ILLUMINATED VISOR MIRROR

To turn on the visor mirror lamps, lift the mirror cover. Adjust the amount of light by sliding the control.

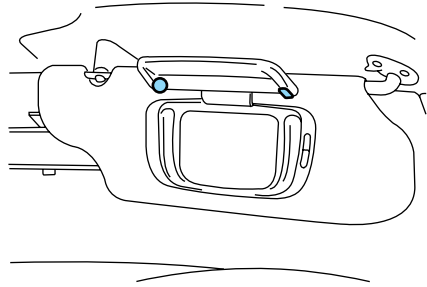

### HOMELINK® UNIVERSAL TRANSCEIVER (IF EQUIPPED)

The HomeLink® Universal Transceiver, located on the driver's visor, provides a convenient way to replace up to three hand-held transmitters with a single built-in device. This feature will learn the radio frequency codes of most current transmitters to operate garage doors, entry gates, security systems, entry door locks, and home or office lighting.



When programming your HomeLink® Universal Transceiver, to a garage door or gate be sure that people and objects are out of the way to prevent potential harm or damage.

Do not use the HomeLink® Universal Transceiver with any garage door opener that lacks safety stop and reverse features as required by U.S. federal safety standards (this includes any garage door opener model manufactured before April 1, 1982). A garage door which cannot detect an object, signaling the door to stop and reverse, does not meet current

## Controls and features

U.S. federal safety standards. For more information on this matter, call toll-free: 1-800-355-3515 or on the Internet at **HomeLink.jci.com**.

### Programming

#### **Do not program the HomeLink® Universal Transceiver with the vehicle parked in the garage.**

1. Prepare for programming the HomeLink® Universal Transceiver by erasing the three factory default codes by holding down the two outside buttons until the red light begins to flash after 20 seconds. Release both buttons.

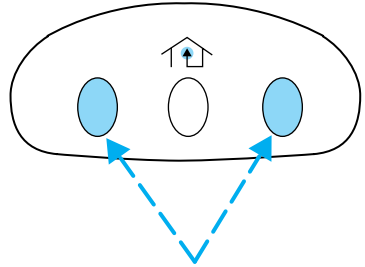

2. Hold the end of your hand-held transmitter 5–14 cm (2–5 inches) away from the HomeLink® Universal Transceiver surface (located on your visor) while keeping the red light in view.

3. Using both hands simultaneously press and hold the hand-held transmitter button and the desired HomeLink® button. Do not release the buttons until step 4 has been completed.

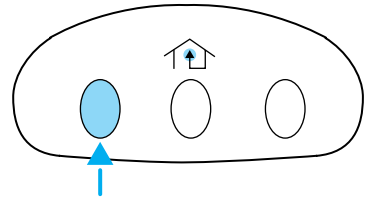

Some entry gates and garage door openers may require you to replace step 3 with the procedure in the “Canadian Programming” section.

4. The red light will flash slowly and then rapidly. Release both buttons when the red light flashes rapidly.

5. Follow steps 2 through 4 to program the remaining two buttons.

If you do not successfully program the HomeLink® Universal Transceiver after repeated attempts, refer to *Rolling code programming* which follows, or call toll-free customer assistance: 1-800-355-3515 or on the Internet at **HomeLink.jci.com**.

## Controls and features

### Canadian Programming

During programming, your hand-held transmitter may automatically stop transmitting after two seconds which may not be long enough to program the HomeLink® Universal Transceiver.

To program your hand-held transmitters:

- continue to hold the button on the HomeLink® Universal Transceiver.
- press and re-press the hand-held transmitter button every two seconds until the red light changes from a slow to a fast flash.

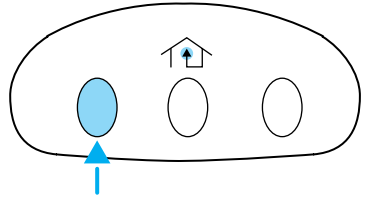

### Operating the HomeLink® Universal Transceiver

Once programmed, the HomeLink® Universal Transceiver can be used in place of hand-held transmitters. To operate, simply press and release the appropriate HomeLink® button (the red light will illuminate, indicating the signal is being transmitted).

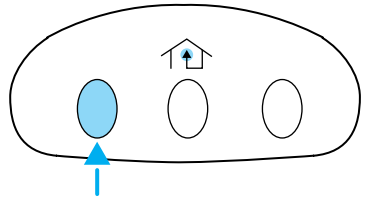

### Rolling code programming

Rolling code garage door openers (or other rolling code devices) which are “code protected” and manufactured after 1996, may be determined by the following:

- Reference the device owner’s manual for verification
- The hand-held transmitter appears to program the HomeLink® Universal Transceiver but does not activate the device.
- Press and hold the trained HomeLink® button. The device has the rolling code feature if the indicator light flashes rapidly and then turns solid after two seconds.



## Controls and features

After completing the “Programming” functions, follow these steps to train a garage door opener with the rolling code feature:

1. Locate the **training button** on the garage door motor head unit. Refer to the garage door opener manual or call 1-800-355-3515 or on the Internet at **HomeLink.jci.com**. if there is difficulty locating the training button.
2. Press the training button on the garage door motor head unit (which will activate the **“training” light** ).
3. Press and release the programmed HomeLink® button. Press and release the HomeLink® button a *second time* to complete the training process. (Some garage door openers may require this procedure to be done a third time to complete the training).

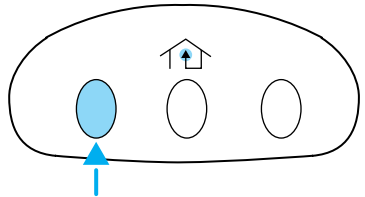

The 2nd or 3rd press from step 3 will activate the door. The HomeLink® Universal Transceiver has now been trained to the receiver. The remaining two buttons may now be programmed if this has not previously been done.

### Erasing HomeLink® buttons

Individual buttons cannot be erased, however, to erase the three programmed buttons:

1. Hold down the two outside buttons until the red light begins to flash after 20 seconds.
2. Release both buttons.

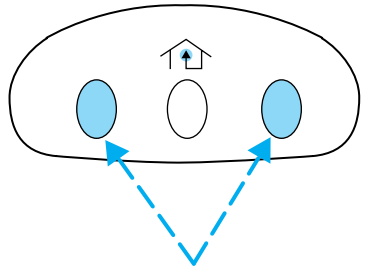

### Reprogramming a single HomeLink® button

To program a device to HomeLink® using a HomeLink® button previously trained, follow these steps:

1. Press and hold the desired HomeLink® button. **Do NOT** release until **step 4** has been completed.

## Controls and features

- When the indicator light begins to flash slowly (after 20 seconds), position the hand-held transmitter 5–14 cm (2 to 5 inches) away from the HomeLink® surface.
- Press and hold the hand-held transmitter button.
- The HomeLink® indicator light will flash, first slowly and then rapidly. When the indicator light begins to flash rapidly, release both buttons. The previous device has now been erased and the new device can be activated by pushing the HomeLink® button that has just been programmed.

### POWER WINDOWS

Press and pull the rocker switches to open and close windows.

- Press the top portion of the rocker switch to open.
- Pull the top portion of the rocker switch to close.

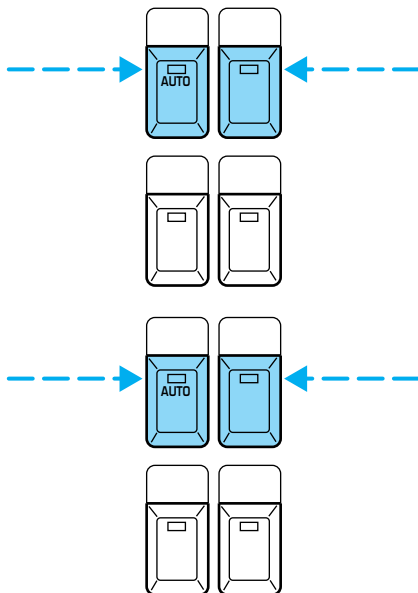

## Controls and features

### Express down

To make the driver window open fully without holding the window control, press the top portion of the driver window control completely down to the second detent. Press or pull the control to stop window operation.

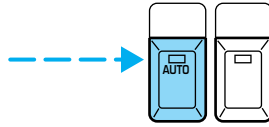

### Window lock

The window lock feature allows only the driver to operate the rear power windows.

To lock out the rear window controls press the left side of the control. Press the right side to restore the window controls.

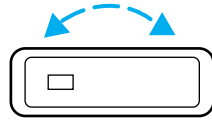

### Accessory delay

With accessory delay, the window switches may be used for up to ten minutes after the ignition switch is turned to the OFF position or until either front door is opened.

### POWER DOOR LOCKS

Press the top of the control to unlock all doors and the bottom to lock all doors.

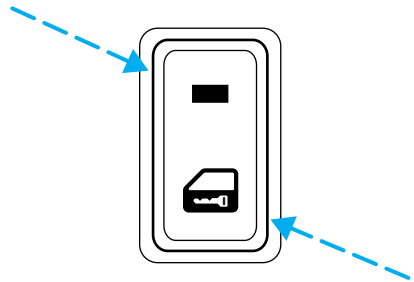

### Smart locks

With the key in the ignition, in any switch position, and either the driver's or passenger's door open, the doors cannot be locked using the front door lock switches.

## Controls and features

While the key is in the ignition, the vehicle can be locked by manually pressing the lock control, operating the remote entry transmitter, or operating the drivers door lock with the key.

### Central locking/Two step unlocking

When unlocking the driver door with the key, turn it once toward the front of the vehicle to unlock that door only. Turn the key a second time to unlock all doors. When locking, turn the key toward the back of the vehicle to lock all doors.

### CHILDPROOF DOOR LOCKS

When these locks are set, the rear doors cannot be opened from the inside. The rear doors can be opened from the outside when the doors are unlocked.

The childproof locks are located on rear edge of each rear door and must be set separately for each door. Setting the lock for one door will not automatically set the lock for both doors.

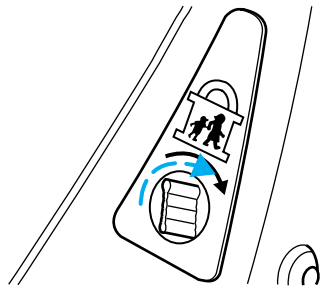

Rotate lock control in the direction of arrow to engage the lock. Rotate control in the opposite direction to disengage childproof locks.

### CENTER CONSOLE

Your vehicle may be equipped with a variety of console features. These include:

- Utility compartment
- Power point (rear of console)
- Traction control (if equipped)
- Cellular phone (if equipped)
- Cupholders
- Air vents to the rear seating positions

### POSITIVE RETENTION FLOOR MAT

Position the floor mat so that the eyelet is over the pointed end of the retention post and rotate forward to lock in. Make sure that the mat does not interfere with the operation of the accelerator or the brake pedal. To remove the floor mat, reverse the installation procedure.

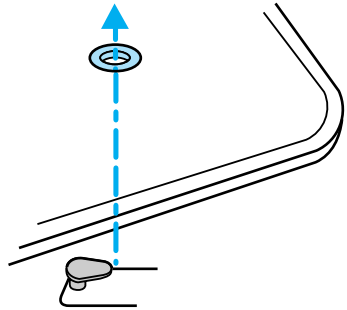

### REMOTE ENTRY SYSTEM

This device complies with part 15 of the FCC rules and with RS-210 of Industry Canada. Operation is subject to the following two conditions: (1) This device may not cause harmful interference, and (2) This device must accept any interference received, including interference that may cause undesired operation.

**Changes or modifications not expressly approved by the party responsible for compliance could void the user's authority to operate the equipment.**

Your remote entry system contains two remote transmitters which provide remote control of several features. Each remote transmitter will allow you to:

- unlock the vehicle doors without a key.
- lock all the vehicle doors without a key.
- open the trunk without a key.
- activate the personal alarm.
- open all windows and moonroof (if equipped).
- arm and disarm the perimeter anti-theft system.
- operate the illuminated entry feature.
- operate the memory seat/mirror/steering column feature (if equipped).

The remote transmitter features only operate with the ignition in the OFF or ACC positions. For vehicles equipped with an automatic transmission, the remote transmitter features also operate if the ignition

## Controls and features

is in the RUN position and the gear shift is in P (Park). The personal alarm feature, however, will not operate when the ignition is in the RUN position.

If there is any potential remote keyless entry problem with your vehicle, ensure **ALL key fobs** (remote entry transmitters) are brought to the dealership, to aid in troubleshooting.

### Unlocking the doors

Press this control to unlock the driver door and disarm the perimeter alarm (if armed). The interior lamps will illuminate and the turn signal lamps will display two short flashes (to indicate disarming of the perimeter alarm).

If the memory seat/mirror/steering column feature (if equipped) is activated, the corresponding seat/mirror/steering column positions will be recalled.

Refer to *Memory seat/mirror/steering column feature* for more information.

Press the control a second time within three seconds to unlock all the doors.

### Opening all windows and moonroof (if equipped)

Press this control and hold down for more than one second to begin to open all the windows and moonroof. Release the control to stop. If the control is held down for more than four seconds, the windows and moonroof will open fully.

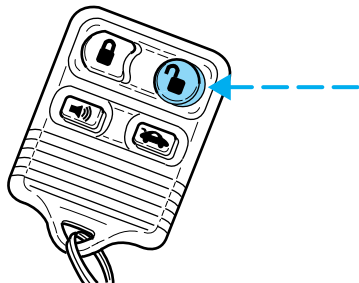
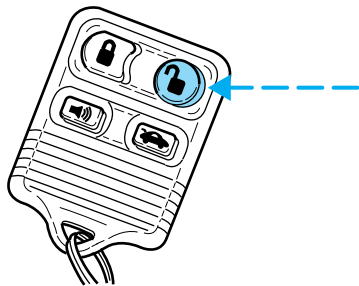

### Locking the doors

Press this control to lock all the doors and arm the perimeter anti-theft system (also enables the ignition tamper security system). To confirm all the doors, hood and trunk are closed, the turn signal lamps will display one short flash. If all the doors, hood and trunk are not closed, the turn signal lamps will display five short flashes.

Press the control a second time within three seconds to receive audible confirmation that all the doors, hood and trunk are closed. The horn will sound one chirp if all the doors, hood and trunk are closed. The horn will sound two chirps if all the doors, hood and trunk are not closed. The audible confirmation feature can be turned off/on through the vehicle message center (if equipped). If your vehicle does not have a vehicle message center, the audible confirmation feature can be turned off/on by your dealer.

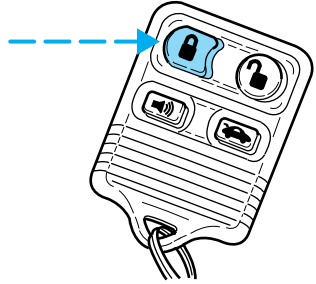

### Opening the trunk

Press this control to open the trunk. Be certain the trunk is closed before driving your vehicle. The trunk may appear closed, but it may not be latched. Failure to do so may cause objects to fall out of the trunk or block rear view vision.

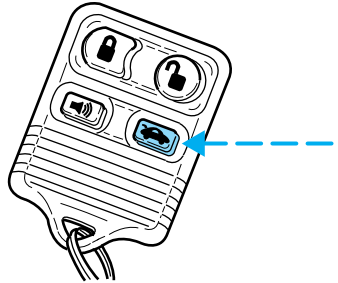

## Controls and features

### Activating the personal alarm

Press this control to turn on the personal alarm.

Press the control a second time to turn off the personal alarm. The personal alarm will also turn off if the remote transmitter unlock control is pressed, or if the ignition switch is turned to the RUN position, or after 30 seconds of operation.

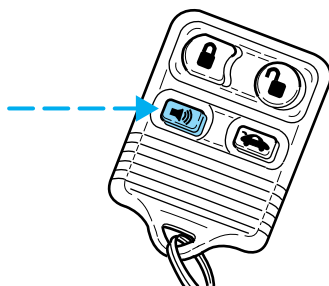

### Illuminated entry

The illuminated entry feature will automatically turn on the interior lamps when the remote transmitter unlock control is pressed.

The illuminated entry feature will automatically turn off the interior lamps if the ignition switch is turned to the RUN position, or if the remote transmitter lock control is pressed, or after 20 seconds of illumination.

The interior lamps will not turn off if:

- they have been turned on with the instrument panel dimmer control switch or
- any door is open.

The battery saver will turn off the interior lamps 40 minutes after the last door is closed even if the dimmer control switch is on.

### Replacing the battery

The remote transmitter is powered by one coin type three-volt lithium battery CR2032 or equivalent. Typical operating range will allow you to be up to 10 meters (33 feet) away from your vehicle. A decrease in operating range can be caused by:

- weather conditions
- nearby radio towers
- structures around the vehicle
- other vehicles parked next to the vehicle



To replace the battery:

1. Twist a thin coin between the two halves of the transmitter near the key ring. **DO NOT TAKE THE FRONT PART OF THE TRANSMITTER APART.**
2. Place the positive (+) side of new battery in the same orientation. Refer to the diagram inside the transmitter unit.
3. Snap the two halves back together.

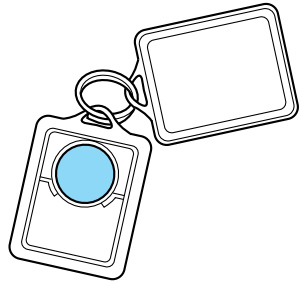

Replacement of the battery will **not** cause the remote transmitter to become deprogrammed from your vehicle. The remote transmitter should operate normally after battery replacement.

### Replacing lost transmitters

If a remote transmitter has been lost and you would like to remove it from the vehicle's memory or you would like to purchase additional transmitters for your vehicle (up to four may be programmed into memory), take **all** your vehicle's transmitters to your dealer for programming. It will be necessary for your dealer to reprogram **all** the remote transmitters to your vehicle while performing this service.

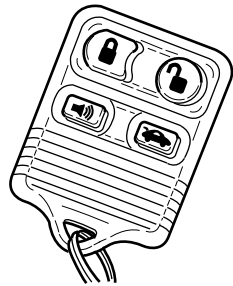

### Autolock/Relock (if equipped)

This feature automatically locks all vehicle doors when:

- all doors are closed
- the engine is running
- you shift into any gear putting the vehicle in motion.

## Controls and features

### **Relock**

The autolock feature repeats when:

- any door, except the drivers, is opened then closed while the engine is running and
- you put the vehicle in motion.

### **Deactivating/activating the autolock/relock feature**

The autolock/relock feature can be turned off or on through the vehicle message center (if equipped). If your vehicle does not have a message center, the feature can be turned off or on by your dealer.

### **Memory seat/mirror/steering column feature (if equipped)**

This feature allows you to recall previously stored seat/mirror/steering column positions with your remote transmitter(s). Up to four remote transmitters can be activated to utilize the two available memory positions.

Press this control to move the seat/mirror/steering column to the previously stored positions.

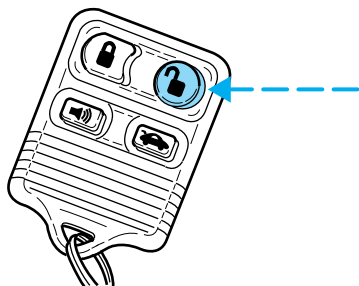

### **Activating the memory seat/mirror/steering column feature**

To activate this feature:

1. Position the seat, mirrors and steering column to the positions you desire.
2. Press the SET control on the driver's door panel.
3. Within 5 five seconds, press one control on the remote transmitter and then press the 1 or 2 button on the driver's door panel to which you would like to associate with the seat/mirror/steering column and Driver 1 or Driver 2 positions.
4. Repeat this procedure for another remote transmitter if desired.

### **Deactivating the memory seat/mirror/steering column feature**

To deactivate this feature:

1. Press the SET control on the driver's door panel.

2. Within 5 five seconds, press one control on the remote transmitter which you would like to deactivate and then press the SET control on the driver's door panel.
3. Repeat this procedure for another remote transmitter if desired.

### PERIMETER ALARM SYSTEM

The perimeter anti-theft system will help protect your vehicle doors, hood and trunk from unauthorized entry.

If there is any potential perimeter anti-theft problem with your vehicle, ensure **ALL key fobs** (remote entry transmitters) are brought to the dealership, to aid in troubleshooting.

#### Arming the system

When armed, the perimeter alarm will help protect your vehicle from unauthorized entry. When unauthorized entry occurs, the system will flash the turn signal lamps and the theft indicator lamp and will sound the horn.

The system is ready to arm whenever the key is out of the ignition. Any of the following actions will arm the alarm system:

- Press the remote transmitter lock control.
- Open a door and press the power door lock control.
- Lock all doors with the key.

The system will wait 20 seconds after one of the arming actions is performed before allowing an alarm to go off.

#### Theft indicator

When the perimeter alarm is armed, the theft indicator on the instrument panel will flash briefly every two seconds to indicate the perimeter alarm system is protecting your vehicle.

#### Disarming the system

You can disarm the system by any of the following actions:

- Unlock the doors by using your remote entry transmitter.
- Unlock the driver's door by using your key.
- Turn ignition to RUN.

## Controls and features

### SECURILOCK™ PASSIVE ANTI-THEFT SYSTEM

SecuriLock™ passive anti-theft system is an engine immobilization system. This system prevents the engine from being started unless a **coded key programmed to your vehicle** is used.

The SecuriLock™ passive anti-theft system is not compatible with non-Ford aftermarket remote start systems. Use of these systems may result in vehicle starting problems and a loss of security protection.

#### Automatic arming

The vehicle is armed immediately after switching the ignition to the 2 (OFF) position. The **THEFT** light in the instrument panel will flash every two seconds when the vehicle is armed.

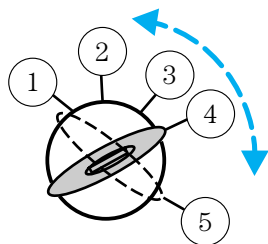

#### Automatic disarming

Switching the ignition to the 4 (ON) position with a **coded key** disarms the vehicle. The **THEFT** light will illuminate for three seconds and then go out. If the **THEFT** light stays on for an extended period of time or flashes rapidly, have the system serviced by your dealership or a qualified technician.

#### Key information

Your vehicle is supplied with **three coded keys** (two master keys and one gray valet key). Only a **coded key** will start your vehicle.

The valet key only starts the vehicle and unlocks/locks the driver's door. Before using this key, press the valet switch in the glove compartment to disable the *Trunk remote control* on the instrument panel, then lock the glove compartment with your master key.

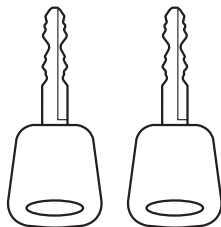

## Controls and features

Spare coded keys can be purchased from your dealership. Your dealership can program your key or you can “do it yourself”, refer to *Programming spare keys*.

The SecuriLock™ passive anti-theft system is not compatible with non-Ford (aftermarket) remote start systems. Use of these systems may result in vehicle starting problems and a loss of security protection.

Large metallic objects, electronic devices on the key chain that can be used to purchase gasoline or similar items, or a second key on the same key ring as the **coded key** ignition key may cause vehicle starting issues. If present, you need to keep these objects from touching the

**coded key** ignition key while

starting the engine. These objects

and devices cannot damage the **coded key** ignition key, but can cause a momentary issue if they are too close to the key during engine start. If a problem occurs, turn ignition OFF and restart the engine with all other objects on the key ring held away from the ignition key. Check to make sure the **coded key** ignition key is an approved Ford **coded key** ignition key.

If your keys are lost or stolen you will need to do the following:

- Use your spare key to start the vehicle. or
- Have your vehicle towed to a dealership or locksmith. The key codes will need to be erased from your vehicle and new key codes will need to be re-coded.

Replacing coded keys can be very costly and you may want to store an extra programmed key away from the vehicle in a safe place to prevent an unforeseen inconvenience.

The correct **coded key** key must be used for your vehicle. The use of the wrong type of **coded key** key may lead to a “NO-START” condition. Refer to the Rotunda Key Application Matrix for the correct **coded key**

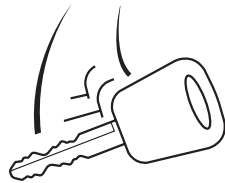
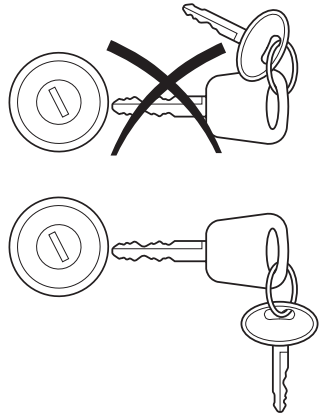

## Controls and features

key type for your particular vehicle make and model year. If a key Application Matrix is not available, call 1-800-ROTUNDA (1-800-768-8632) (press 2) to order a Key Application Matrix.



If an unprogrammed key is used in the ignition it will cause a “**NO START**” condition.

### Programming spare keys

A maximum of eight keys can be coded to your vehicle. Only SecuriLock<sup>™</sup> keys can be used. To program a **coded key** yourself, you will need two previously programmed **coded keys** (keys that already operate your vehicle's engine) and the new unprogrammed key(s) readily accessible for timely implementation of each step in the procedure.

If two previously programmed coded keys are not available (one or both of your original keys were lost or stolen), you must bring your vehicle to your dealership to have the spare coded key(s) programmed.

Please read and understand the entire procedure before you begin.

1. Insert the first previously programmed **coded key** into the ignition and turn the ignition from 1 (LOCK) to 4 (RUN) (maintain ignition in 4 (RUN) for at least one second).

2. Turn ignition to 1 (LOCK) and remove the first **coded key** from the ignition.

3. Within ten seconds of turning the ignition to 1 (LOCK), insert the second previously programmed **coded key** into the ignition and turn the ignition from 1 (LOCK) to 4 (RUN) (maintain ignition in 4 (RUN) for at least one second but no more than ten seconds).

4. Turn the ignition to 1 (LOCK) and remove the second **coded key** from the ignition.

5. Within 20 seconds of turning the ignition to 1 (LOCK), insert the new unprogrammed key (new key/valet key) into the ignition and turn the ignition from 1 (LOCK) to 4 (RUN) (maintain ignition in 4 (RUN) for at least one second). This step will program your new key to a coded key.

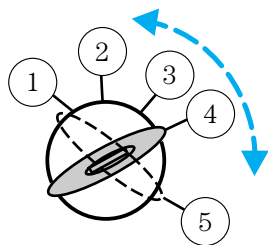

## Controls and features

6. To program additional new unprogrammed key(s), repeat this procedure from step 1.

If successful, the new coded key(s) will start the vehicle's engine and the theft indicator will illuminate for three seconds and then go out.

If not successful, the new coded key(s) will not start the vehicle's engine and the theft indicator will flash on and off. If failure repeats, bring your vehicle to your dealership to have the new spare key(s) programmed.

### INTERIOR LUGGAGE COMPARTMENT RELEASE

Your vehicle is equipped with a mechanical interior luggage compartment release handle that provides a means of escape for children and adults in the event they become locked inside the luggage compartment.

Adults are advised to familiarize themselves with the operation and location of the release handle.

To open the luggage compartment door (lid) from the inside, pull the illuminated "T" shaped handle and push up on the trunk lid. The material that the handle is made of will glow for hours in the darkness of the luggage compartment following brief exposure to ambient light.

The "T" shaped handle will be located either on the luggage compartment door (lid) or inside the luggage compartment near the tail lamps.

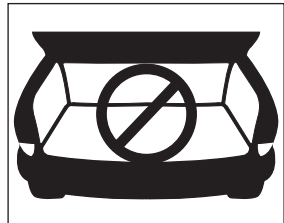
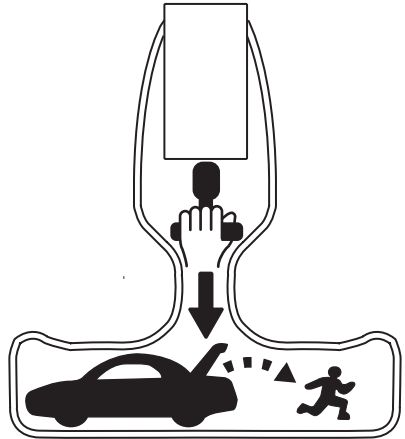

## Controls and features



Keep vehicle doors and luggage compartment locked and keep keys out of a child's reach. Unsupervised children could lock themselves in an open trunk and risk injury. Children should be taught not to play in vehicles.



On hot days, the temperature in the trunk or vehicle interior can rise very quickly. Exposure of people or animals to these high temperatures for even a short time can cause death or serious heat-related injuries, including brain damage. Small children are particularly at risk.



## Seating and safety restraints

### SEATING

#### Adjustable head restraints (if equipped)

Your vehicle's seats may be equipped with head restraints which are vertically adjustable. The purpose of these head restraints is to help limit head motion in the event of a rear collision. To properly adjust your head restraints, lift the head restraint so that it is located directly behind your head or as close to that position as possible. Refer to the following to raise and lower the head restraints.

The head restraints can be moved up and down.

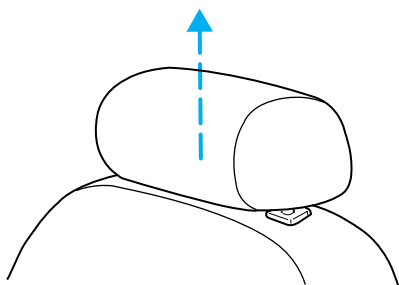

Push control to lower head restraint.

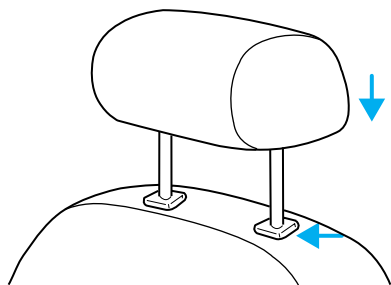

#### Four-way head restraints (if equipped)

Your vehicle's seats may be equipped with four-way adjustable head restraints. The purpose of these head restraints is to help limit head motion in the event of a rear collision. To properly adjust your head restraints, lift the head restraint so that it is located directly behind your head or as close to that position as possible. Refer to the following to raise and lower the head restraints.

## Seating and safety restraints

The head restraints can be moved in four directions and use the same release control as the two-way head restraints:

- up and down
- forward or backward

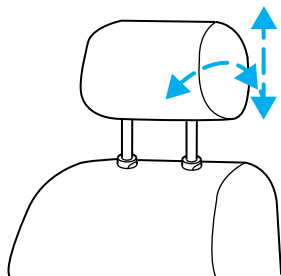

### Adjusting the power seats

The power seat controls are located on the outboard side of the seat.



Never adjust the driver's seat or seatback when the vehicle is moving.



Always drive and ride with your seatback upright and the lap belt snug and low across the hips.



Reclining the seatback can reduce the effectiveness of the seat's safety belt in the event of a collision.

Rotate the vertical control to adjust the seatback.

- 8 way
- 6 way

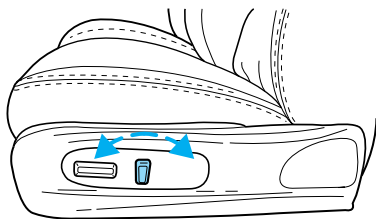

Slide the control forward or backward to move the seat forward or backward.

- 8 way
- 6 way

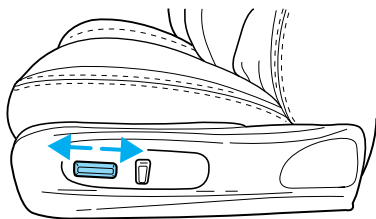

## Seating and safety restraints

Move the control up or down to move the seat up and down.

- 8 way
- 6 way

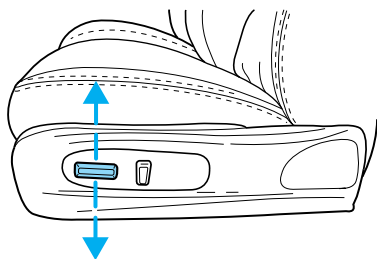

Move front/rear of control up/down to tilt seat cushion.

- 8 way

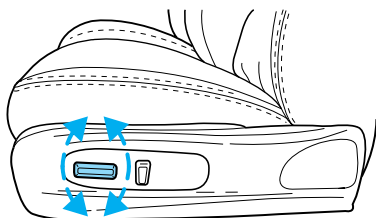

### Heated seats (if equipped)

To operate the heated seats:

- Push control to activate.
- Push again to deactivate.

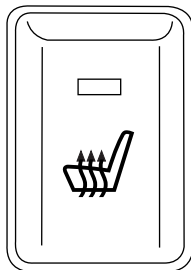

The heated seats will activate when the ignition is in the RUN position. When activated, they will turn off automatically after 10 minutes or when the ignition is turned to the OFF position.

The indicator light will illuminate when the heated seats have been activated.

## Seating and safety restraints

### Using the power lumbar support (if equipped)

The power lumbar control is located on the outboard side of the seat.

Press one side of the control to adjust firmness.

Press the other side of the control to adjust softness.

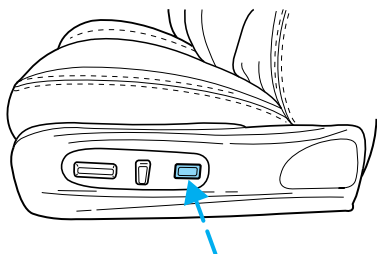

### Using the manual lumbar support (if equipped)

The lumbar control is located on the front of the seat cushion.

Turn to adjust lumbar support.

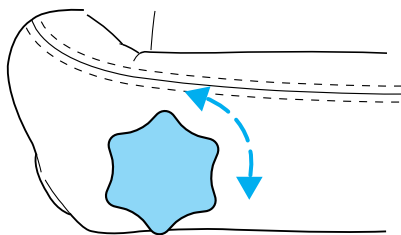

### Easy access/easy out feature (if equipped)

This feature automatically moves the driver's seat backward when:

- the transmission is in N (Neutral) or P (Park)
- the key is removed from the ignition cylinder

The seat will move 5 cm (2 inches) forward (to the original position) when:

- the transmission is in N (Neutral) or P (Park)
- the key is placed in the ignition cylinder

### **Deactivating/activating the easy access/easy out feature**

The easy access/easy out feature can be turned off or on through the vehicle message center (if equipped). If your vehicle does not have a message center, the feature can be turned off or on by your dealer.

## Seating and safety restraints

### Memory seats/steering column/mirrors (if equipped)

This system allows automatic positioning of the driver seat, outside rearview mirrors, and power adjusted tilt/telescope steering column to two programmable positions.

The memory seat control is located on the driver door.

- To program position one, move the driver seat to the desired position using the seat controls. Press the SET control. The SET control indicator light will briefly illuminate. While the light is illuminated, press control 1.
- To program position two, repeat the previous procedure using control 2.

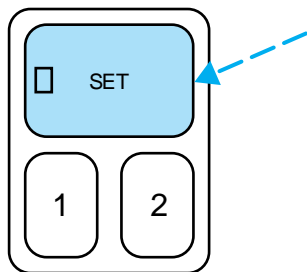

A position can only be set or recalled when the transmission gearshift is in Park (automatic transmission) or the park brake is set (manual transmission). A memory seat position may be programmed at any time.

The memory seat positions are also recalled when you press your remote entry transmitter UNLOCK control.

To program the memory seat to remote entry transmitter, refer to *Remote entry system* in the *Controls and features chapter*.

### 2ND SEAT/SPLIT-FOLDING REAR SEAT

One or both rear seatbacks can be folded down to provide additional cargo space.

To lower the seatback(s), pull the release handle(s) located inside the trunk.

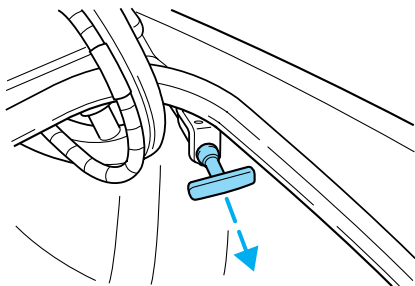

## Seating and safety restraints

Fold the seatback(s) down.

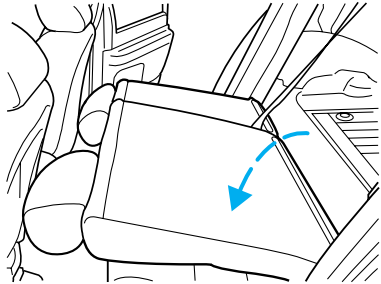

When raising the seatback(s), make sure you hear the seat latch into place.

Make sure that the safety belt for the rear center passenger is properly routed over the rear seatback.

### SAFETY RESTRAINTS

#### Safety restraints precautions



Always drive and ride with your seatback upright and the lap belt snug and low across the hips.



To reduce the risk of injury, make sure children sit where they can be properly restrained.



Never let a passenger hold a child on his or her lap while the vehicle is moving. The passenger cannot protect the child from injury in a collision.



All occupants of the vehicle, including the driver, should always properly wear their safety belts, even when an air bag SRS is provided.

## Seating and safety restraints



It is extremely dangerous to ride in a cargo area, inside or outside of a vehicle. In a collision, people riding in these areas are more likely to be seriously injured or killed. Do not allow people to ride in any area of your vehicle that is not equipped with seats and safety belts. Be sure everyone in your vehicle is in a seat and using a safety belt properly.



In a rollover crash, an unbelted person is significantly more likely to die than a person wearing a safety belt.



Each seating position in your vehicle has a specific safety belt assembly which is made up of one buckle and one tongue that are designed to be used as a pair. 1) Use the shoulder belt on the outside shoulder only. Never wear the shoulder belt under the arm. 2) Never swing the safety belt around your neck over the inside shoulder. 3) Never use a single belt for more than one person.



Always transport children 12 years old and under in the back seat and always properly use appropriate child restraints.

## Seating and safety restraints

### Combination lap and shoulder belts

- Front seat belts

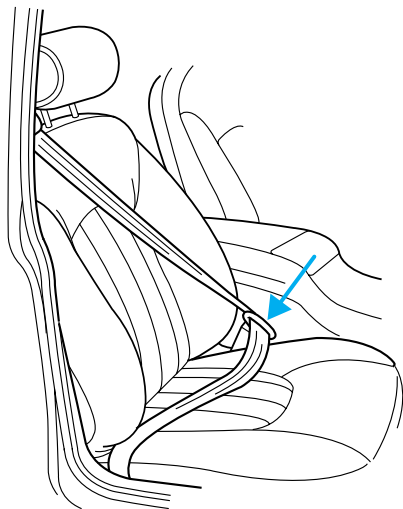

- Rear seat belts

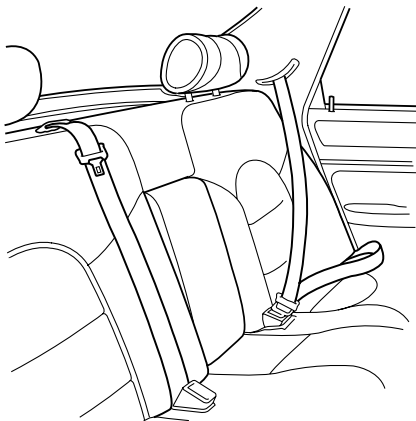



## Seating and safety restraints

1. Insert the belt tongue into the proper buckle (the buckle closest to the direction the tongue is coming from) until you hear a snap and feel it latch. Make sure the tongue is securely fastened in the buckle.

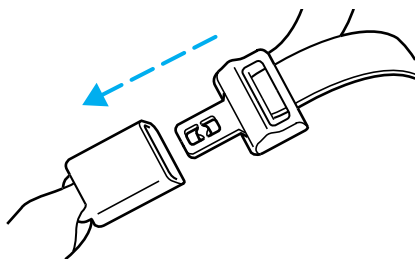

2. To unfasten, push the release button and remove the tongue from the buckle.

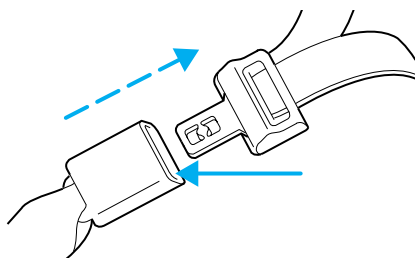

The front outboard and rear safety restraints in the vehicle are combination lap and shoulder belts. The front passenger and rear seat safety belts have two types of locking modes described below:

### Energy Management Feature

The front outboard and rear safety restraints in the vehicle are combination lap and shoulder belts. The front passenger and rear seat safety belts have two types of locking modes.

- This vehicle has a seat belt system with an energy management feature at the front outboard seating positions to help further reduce the risk of injury in the event of a head-on collision.
- This seat belt system has a retractor assembly that is designed to pay out webbing in a controlled manner. This feature is designed to help reduce the belt force acting on the occupant's chest.



After any vehicle collision, the seat belt system at all passenger seating positions must be checked by a qualified technician to verify that the “automatic locking retractor” feature for child seats is still functioning properly. In addition, all seat belts should be checked for proper function.

## Seating and safety restraints

 **BELT AND RETRACTOR ASSEMBLY MUST BE REPLACED** if the seat belt assembly “automatic locking retractor” feature or any other seat belt function is not operating properly when checked according to the procedures in Workshop Manual.

 Failure to replace the Belt and Retractor assembly could increase the risk of injury in collisions.

### Vehicle sensitive mode

The vehicle sensitive mode is the normal retractor mode, allowing free shoulder belt length adjustment to your movements and locking in response to vehicle movement. For example, if the driver brakes suddenly or turns a corner sharply, or the vehicle receives an impact of approximately 8 km/h (5 mph) or more, the combination safety belts will lock to help reduce forward movement of the driver and passengers.

### Automatic locking mode

#### *How to use the automatic locking mode*

- Buckle the combination lap and shoulder belt.

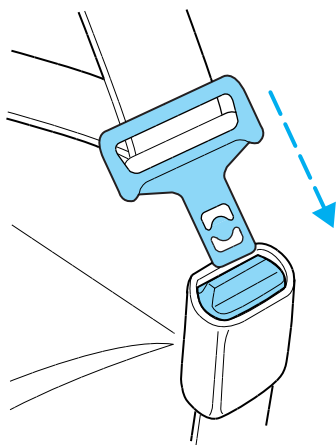

## Seating and safety restraints

- Grasp the shoulder portion and pull downward until the entire belt is extracted.



- Allow the belt to retract. As the belt retracts, you will hear a clicking sound. This indicates the safety belt is now in the automatic locking mode.

In this mode, the shoulder belt is automatically pre-locked. The belt will still retract to remove any slack in the shoulder belt.

The automatic locking mode is not available on the driver safety belt.

### ***When to use the automatic locking mode***

- **Anytime** a child safety seat is installed in the vehicle. Children 12 years old and under should be properly restrained in the rear seat whenever possible. Refer to *Safety Restraints for Children* or *Safety Seats for Children* later in this chapter.

### ***How to disengage the automatic locking mode***

Disconnect the combination lap/shoulder belt and allow it to retract completely to disengage the automatic locking mode and activate the vehicle sensitive (emergency) locking mode.



After any vehicle collision, the seat belt system at all passenger seating positions must be checked by a qualified technician to verify that the “automatic locking retractor” feature for child seats is still functioning properly, in addition to other checks for proper seat belt system function.



**BELT AND RETRACTOR ASSEMBLY MUST BE REPLACED** if the seat belt assembly “automatic locking retractor” feature or any other seat belt function is not operating properly. In addition, all seat belts should be checked for proper function.

## Seating and safety restraints



Failure to replace the Belt and Retractor assembly could increase the risk of injury in collisions.

### Safety belt pretensioner

Your vehicle is equipped with safety belt pretensioners at the driver and front passenger seating positions.

The safety belt pretensioner is a device which removes excess webbing from the safety belt system. The safety belt pretensioner uses the same crash sensor system as the front air bag supplemental restraint system (SRS). When the safety belt pretensioner deploys, webbing from the lap and shoulder belt is tightened. The driver and front passenger seat belt system (including retractors, buckles and height adjusters) must be replaced if the vehicle is involved in a collision that results in deployment of front air bags and safety belt pretensioners. Refer to the *Safety belt maintenance* section in this chapter.



Failure to replace the safety belt assembly under the above conditions could result in severe personal injuries in the event of a collision.

## Seating and safety restraints

### Front safety belt height adjustment

Your vehicle has safety belt height adjustments for the driver and front passenger. Adjust the height of the shoulder belt so the belt rests across the middle of your shoulder.

To lower the shoulder belt height, push the button and slide the height adjuster down. To raise the height of the shoulder belt, slide the height adjuster up. Pull down on the height adjuster to make sure it is locked in place.

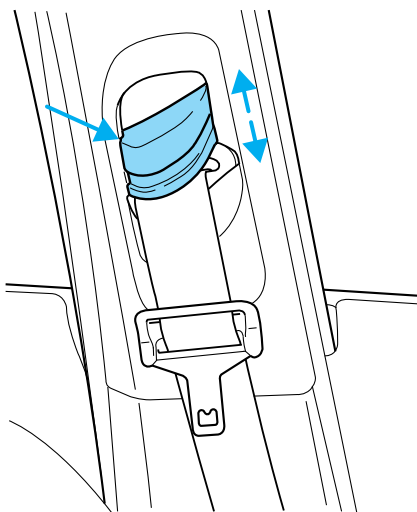

Position the shoulder belt height adjusters so that the belt rests across the middle of your shoulder. Failure to adjust the safety belt properly could reduce the effectiveness of the seat belt and increase the risk of injury in a collision.

### Safety belt warning light and indicator chime

The seat belt warning light illuminates in the instrument cluster and a chime sounds to remind the occupants to fasten their safety belts.

### Conditions of operation

If...	Then...
The driver's safety belt is not buckled before the ignition switch is turned to the RUN position...	The safety belt warning light illuminates 1-2 minutes and the warning chime sounds 4-8 seconds.
The driver's safety belt is buckled while the indicator light is illuminated and the warning chime is sounding...	The safety belt warning light and warning chime turn off.
The driver's safety belt is buckled before the ignition switch is turned to the RUN position...	The safety belt warning light and indicator chime remain off.

## Seating and safety restraints

### Belt minder

The Belt Minder feature is a supplemental warning to the safety belt warning function. This feature provides additional reminders to the driver that the driver's safety belt is unbuckled by intermittently sounding a chime and illuminating the safety belt warning lamp in the instrument cluster.

If...	Then...
The driver's safety belt is not buckled before the vehicle has reached at least 5 km/h (3 mph) and 1-2 minutes have elapsed since the ignition switch has been turned to ON...	The Belt Minder feature is activated - the safety belt warning light illuminates and the warning chime sounds for 6 seconds every 30 seconds, repeating for approximately 5 minutes or until safety belt is buckled.
The driver's safety belt is buckled while the safety belt indicator light is illuminated and the safety belt warning chime is sounding...	The Belt Minder feature will not activate.
The driver's safety belt is buckled before the ignition switch is turned to the ON position...	The Belt Minder feature will not activate.

The purpose of the Belt Minder is to remind occasional wearers to wear safety belts all of the time.

The following are reasons most often given for not wearing safety belts: (All statistics based on U.S. data)

Reasons given...	Consider...
"Crashes are rare events"	<b>36 700 crashes occur every day.</b> The more we drive, the more we are exposed to "rare" events, even for good drivers. <i>1 in 4 of us will be seriously injured in a crash during our lifetime.</i>
"I'm not going far"	<b>3 of 4</b> fatal crashes occur within <b>25</b> miles of home.
"Belts are uncomfortable"	Ford designs its safety belts to enhance comfort. If you are uncomfortable - try different positions for the safety belt upper anchorage and seatback which should be as upright as possible; this can improve comfort.
"I was in a hurry"	<b>Prime time for an accident.</b> Belt Minder reminds us to take a few seconds to buckle up.

## Seating and safety restraints

Reasons given...	Consider...
“Seat belts don’t work”	<b>Safety belts</b> , when used properly, <b>reduce risk of death</b> to front seat occupants by <b>45% in cars</b> , and by <b>60% in light trucks</b> .
“Traffic is light”	<b>Nearly 1 of 2 deaths occur in single-vehicle crashes</b> , many when no other vehicles are around.
“Belts wrinkle my clothes”	Possibly, but a serious crash can do much more than wrinkle your clothes, particularly if you are unbelted.
“The people I’m with don’t wear belts”	Set the example, teen deaths occur 4 times more often in vehicles with TWO or MORE people. Children and younger brothers/sisters imitate behavior they see.
“I have an air bag”	Air bags offer greater protection when used with safety belts. Frontal airbags are not designed to inflate in rear and side crashes or rollovers.
“I’d rather be thrown clear”	Not a good idea. <b>People</b> who are <b>ejected are 40 times more likely to DIE</b> . Safety belts help prevent ejection, WE CAN’T “PICK OUR CRASH”.



Do not sit on top of a buckled safety belt to avoid the Belt Minder chime. Sitting on the safety belt will increase the risk of injury in an accident. To disable (one-time) or deactivate the Belt Minder feature please follow the directions stated below.

### **One time disable**

Anytime the safety belt is buckled and then unbuckled during an ignition ON cycle, Belt Minder will be disabled for that ignition cycle only.

### **Deactivating/activating the belt minder feature**

*Read steps 1 - 9 thoroughly before proceeding with the deactivation/activation programming procedure.*

The Belt Minder feature can be deactivated/activated by performing the following procedure:

Before following the procedure, make sure that:

- the parking brake is set
- the gearshift is in P (Park) (automatic transmission) or the neutral position (manual transmission).

## Seating and safety restraints

- the ignition switch is in the OFF position
- all vehicle doors are closed
- the driver's safety belt is unbuckled
- the parklamps/headlamps are in OFF position (If vehicle is equipped with Autolamps, this will not affect the procedure.)



To reduce the risk of injury, do not deactivate/activate the Belt Minder feature while driving the vehicle.

1. Turn the ignition switch to the RUN (or ON) position. (DO NOT START THE ENGINE)
2. Wait until the safety belt warning light turns off. (Approximately 1–2 minutes)
  - Steps 3–5 must be completed within 60 seconds or the procedure will have to be repeated.
3. Buckle then unbuckle the safety belt three times, ending with the safety belt unbuckled. This can be done before or during Belt Minder warning activation.
4. Turn on the parklamps/headlamps, turn off the parklamps/headlamps.
5. Buckle then unbuckle the safety belt three times, ending with the safety belt unbuckled.
  - After step 5 the safety belt warning light will be turned on for three seconds.
6. Within seven seconds of the safety belt warning light turning off, buckle then unbuckle the safety belt.
  - This will disable Belt Minder if it is currently enabled, or enable Belt Minder if it is currently disabled.
7. Confirmation of disabling Belt Minder is provided by flashing the safety belt warning light four times per second for three seconds.
8. Confirmation of enabling Belt Minder is provided by flashing the safety belt warning light four times per second for three seconds, followed by three seconds with the safety belt warning light off, then followed by flashing the safety belt warning light four times per second for three seconds again.
9. After receiving confirmation, the deactivation/activation procedure is complete.



## Seating and safety restraints

### Safety belt extension assembly

If the safety belt assembly is too short for you, even when fully extended, 20 cm (8 inches) can be added to the safety belt assembly by adding a safety belt extension assembly (part number 611C22). Safety belt extension assemblies can be obtained from your dealer at no cost.

Use only extensions manufactured by the same supplier as the safety belt. Manufacturer identification is located at the end of the webbing on the label. Also, use the safety belt extension only if the safety belt is too short for you when fully extended. Do not use extensions to change the fit of the shoulder belt across the torso.

### Safety belt maintenance

Inspect the safety belt systems periodically to make sure they work properly and are not damaged. Inspect the safety belts to make sure there are no nicks, wears or cuts, replacing if necessary. All safety belt assemblies, including retractors, buckles, front seat belt buckle assemblies, buckle support assemblies (slide bar-if equipped), shoulder belt height adjusters (if equipped), shoulder belt guide on seatback (if equipped), child safety seat tether bracket assemblies (if equipped), LATCH child seat tether anchors and lower anchors (if equipped), and attaching hardware, should be inspected after a collision. Ford recommends that all safety belt assemblies used in vehicles involved in a collision be replaced. However, if the collision was minor and a qualified technician finds that the belts do not show damage and continue to operate properly, they do not need to be replaced. Safety belt assemblies not in use during a collision should also be inspected and replaced if either damage or improper operation is noted.



Failure to inspect and if necessary replace the safety belt assembly under the above conditions could result in severe personal injuries in the event of a collision.

Refer to *Cleaning and maintaining the safety belts* in the *Maintenance and care* section.

## Seating and safety restraints

### AIR BAG SUPPLEMENTAL RESTRAINT SYSTEM (SRS)

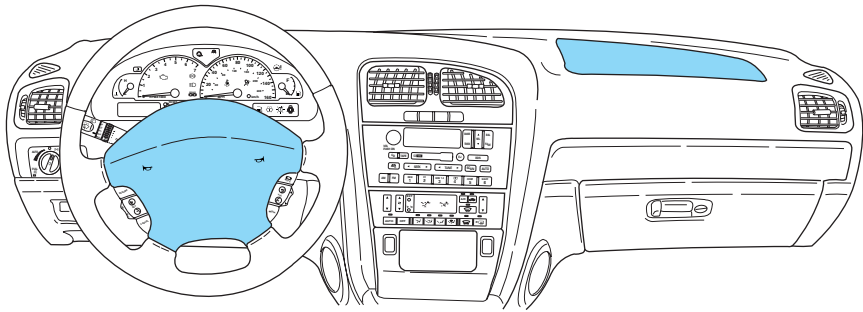

Your vehicle is equipped with a crash sensing and diagnostic module which records information about the air bag and sensor systems. In the event of a collision this module may save information related to the collision including information about the air bag system and impact severity. This information will assist Ford in the servicing of your vehicle and may help Ford better understand real world collisions and further improve the safety of future vehicles.

### Important supplemental restraint system (SRS) precautions

The supplemental restraint system is designed to work with the safety belt to help protect the driver and right front passenger from certain upper body injuries.

Air bags DO NOT inflate slowly or gently and the risk of injury from a deploying air bag is greatest close to the trim covering the air bag module.

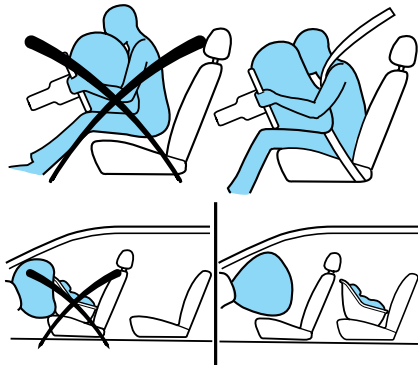

All occupants of the vehicle, including the driver, should always properly wear their safety belts, even when an air bag SRS is provided.

## Seating and safety restraints



Always transport children 12 years old and under in the back seat and always properly use appropriate child restraints.



National Highway Traffic Safety Administration (NHTSA) recommends a minimum distance of at least 25 cm (10 inches) between an occupant's chest and the driver air bag module.



Never place your arm over the air bag module as a deploying air bag can result in serious arm fractures or other injuries.

Steps you can take to properly position yourself away from the air bag:

- Move your seat to the rear as far as you can while still reaching the pedals comfortably.
- Recline the seat slightly (one or two degrees) from the upright position.



Do not put anything on or over the air bag module. Placing objects on or over the air bag inflation area may cause those objects to be propelled by the air bag into your face and torso causing serious injury.



Do not attempt to service, repair, or modify the Air Bag Supplemental Restraint System or its fuses. See your Ford or Lincoln Mercury dealer.



Modifications to the front end of the vehicle, including frame, bumper, front end body structure and tow hooks may effect the performance of the air bag sensors increasing the risk of injury. Do not modify the front end of the vehicle.

## Seating and safety restraints

### Children and air bags

For additional important safety information, read all information on safety restraints in this guide.

Children must always be properly restrained. Accident statistics suggest that children are safer when properly restrained in the rear seating positions than in the front seating position. Failure to follow these instructions may increase the risk of injury in a collision.

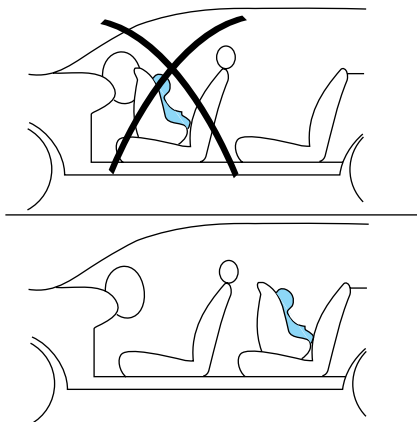

Air bags can kill or injure a child in a child seat.

**NEVER** place a rear-facing child seat in front of an active air bag. If you must use a forward-facing child seat in the front seat, move the seat all the way back.

### How does the safety belt pretensioner and air bag supplemental restraint system work?

The safety belt pretensioner and air bag SRS are designed to activate when the vehicle sustains longitudinal deceleration sufficient to cause the sensors to close an electrical circuit that initiates pretensioner activation and air bag inflation.

The fact that the pretensioners and air bags did not activate in a collision does not mean that something is wrong with the system. Rather, it means the forces were not of the type sufficient to cause activation. Front air bags and pretensioners are designed to activate in frontal and near-frontal collisions, not rollover, side-impact, or rear-impacts unless the collision causes sufficient longitudinal deceleration.

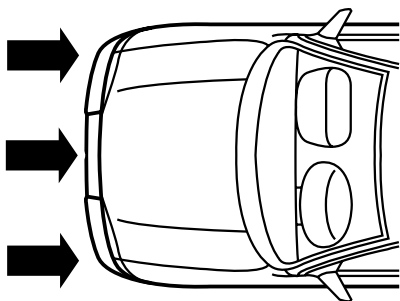

## Seating and safety restraints

The air bags inflate and deflate rapidly upon activation. After air bag deployment, it is normal to notice a smoke-like, powdery residue or smell the burnt propellant. This may consist of cornstarch, talcum powder (to lubricate the bag) or sodium compounds (e.g., baking soda) that result from the combustion process that inflates the air bag. Small amounts of sodium hydroxide may be present which may irritate the skin and eyes, but none of the residue is toxic.



While the system is designed to help reduce serious injuries, contact with a deploying air bag may also cause abrasions, swelling or temporary hearing loss. Because air bags must inflate rapidly and with considerable force, there is the risk of death or serious injuries such as fractures, facial and eye injuries or internal injuries, particularly to occupants who are not properly restrained or are otherwise out of position at the time of air bag deployment. Thus, it is extremely important that occupants be properly restrained as far away from the air bag module as possible while maintaining vehicle control.



Several air bag system components get hot after inflation. Do not touch them after inflation.



If the air bag has deployed, **the air bag will not function again and must be replaced immediately.** If the air bag is not replaced, the unrepaired area will increase the risk of injury in a collision.

The SRS consists of:

- driver and passenger air bag modules (which include the inflators and air bags).
- side air bags (if equipped). Refer to *Side air bag system* later in this chapter.
- safety belt pretensioners.

## Seating and safety restraints

- one or more impact and safing sensors.
- a readiness light and tone.
- and the electrical wiring which connects the components.

The diagnostic module monitors its own internal circuits and the supplemental air bag electrical system warning (including the impact sensors), the system wiring, the air bag system readiness light, the air bag back up power, the air bag ignitors and safety belt pretensioners.

### Determining if the system is operational

The SRS uses a readiness light in the instrument cluster or a tone to indicate the condition of the system. Refer to the *Air bag readiness* section in the *Instrumentation* chapter. Routine maintenance of the air bag is not required.

A difficulty with the system is indicated by one or more of the following:

- The readiness light will either flash or stay lit.
- The readiness light will not illuminate immediately after ignition is turned to the RUN position.
- A series of five beeps will be heard. The tone pattern will repeat periodically until the problem and/or light are repaired.



If any of these things happen, even intermittently, have the SRS serviced at your dealership or by a qualified technician immediately. Unless serviced, the system may not function properly in the event of a collision.

### Side air bag system



Do not place objects or mount equipment on or near the air bag cover on the side of the seatbacks of the front seats or in front seat areas that may come into contact with a deploying air bag. Failure to follow these instructions may increase the risk of personal injury in the event of a collision.

## Seating and safety restraints



Do not use accessory seat covers. The use of accessory seat covers may prevent the deployment of the side air bags and increase the risk of injury in an accident.



Do not lean your head on the door. The side air bag could injure you as it deploys from the side of the seatback.



Do not attempt to service, repair, or modify the air bag Supplemental Restraint System, its fuses or the seat cover on a seat containing an air bag. See your Ford or Lincoln Mercury dealer.



All occupants of the vehicle including the driver should always wear their safety belts even when an air bag SRS is provided.

### ***How does the side air bag system work?***

The side air bag system consists of the following:

- An inflatable nylon bag (air bag) with a gas generator concealed behind the outboard bolster of the driver and front passenger seatbacks.
- A special seat cover designed to allow airbag deployment.
- The same warning light, electronic control and diagnostic unit as used for the front air bags.
- Two crash sensors located under the outboard side of the front seats, attached near the floor.

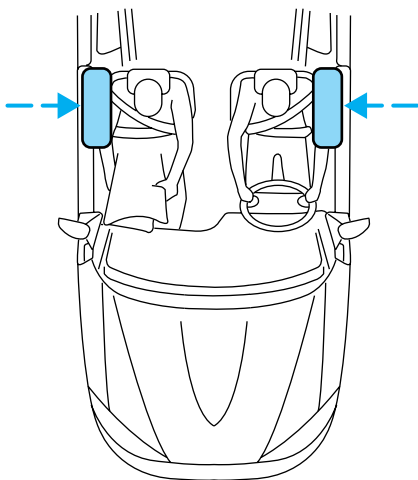

Side air bags, in combination with seat belts, can help reduce the risk of severe injuries in the event of a significant side impact collision.

The side air bags are fitted on the outboard side of the seatbacks of the front seats. In certain lateral collisions, the air bag on the side affected by the collision will be inflated, even if the respective seat is not

## Seating and safety restraints

occupied. The air bag was designed to inflate between the door panel and occupant to further enhance the protection provided occupants in side impact collisions.

The air bag SRS is designed to activate when the vehicle sustains lateral deceleration sufficient to cause the sensors to close an electrical circuit that initiates air bag inflation.

The fact that the air bags did not inflate in a collision does not mean that something is wrong with the system. Rather, it means the forces were not of the type sufficient to cause activation. Side air bags are designed to inflate in side-impact collisions, not roll-over, rear-impact, frontal or near-frontal collisions, unless the collision causes sufficient lateral deceleration.



Several air bag system components get hot after inflation. Do not touch them after inflation.



If the side air bag has deployed, **the air bag will not function again. The side air bag system (including the seat) must be inspected and serviced by a qualified technician in accordance with the vehicle service manual.** If the air bag is not replaced, the unrepaired area will increase the risk of injury in a collision.

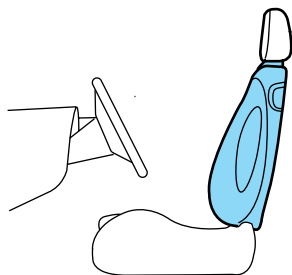

### ***Determining if the system is operational***

The SRS uses a readiness light in the instrument cluster or a tone to indicate the condition of the system. Refer to the *Air bag readiness* section in the *Instrumentation* chapter. Routine maintenance of the air bag is not required.

A difficulty with the system is indicated by one or more of the following:

- The readiness light (same light as used for front air bag system) will either flash or stay lit.



## Seating and safety restraints

- The readiness light will not illuminate immediately after ignition is turned to the RUN position.
- A series of five beeps will be heard. The tone pattern will repeat periodically until the problem and light are repaired.

If any of these things happen, even intermittently, have the SRS serviced at your dealership or by a qualified technician immediately. Unless serviced, the system may not function properly in the event of a collision.

### Disposal of air bags and air bag equipped vehicles (including pretensioners)

For disposal of air bags or air bag equipped vehicles, see your local dealership or qualified technician. Air bags **MUST BE** disposed of by qualified personnel.

### SAFETY RESTRAINTS FOR CHILDREN

See the following sections for directions on how to properly use safety restraints for children. Also see *Air Bag Supplemental Restraint System (SRS)* in this chapter for special instructions about using air bags.

#### Important child restraint precautions

You are required by law to use safety restraints for children in the U.S. and Canada. If small children ride in your vehicle (generally children who are four years old or younger and who weigh 18 kg [40 lbs] or less), you must put them in safety seats made especially for children. Check your local and state or provincial laws for specific requirements regarding the safety of children in your vehicle.



Never let a passenger hold a child on his or her lap while the vehicle is moving. The passenger cannot protect the child from injury in a collision.

Always follow the instructions and warnings that come with any infant or child restraint you might use.

When possible, always place children under age 12 in the rear seat of your vehicle. Accident statistics suggest that children are safer when properly restrained in the rear seating positions than in the front seating position.

## Seating and safety restraints

### Children and safety belts

If the child is the proper size, restrain the child in a safety seat.

Children who are too large for child safety seats (as specified by your child safety seat manufacturer) should always wear safety belts.

Follow all the important safety restraint and air bag precautions that apply to adult passengers in your vehicle.

If the shoulder belt portion of a combination lap and shoulder belt can be positioned so it does not cross or rest in front of the child's face or neck, the child should wear the lap and shoulder belt. Moving the child closer to the center of the vehicle may help provide a good shoulder belt fit.



Do not leave children, unreliable adults, or pets unattended in your vehicle.

To improve the fit of lap and shoulder belts on children who have outgrown child safety seats, Ford recommends use of a belt-positioning booster seat that is labelled as conforming to all applicable Federal motor vehicle safety standards. Belt-positioning booster seats raise the child and provide a shorter, firmer seating cushion that encourages safer seating posture and better fit of lap and shoulder belts on the child.

A belt-positioning booster should be used if the shoulder belt rests in front of the child's face or neck, or if the lap belt does not fit snugly on both thighs, or if the thighs are too short to let the child sit all the way back on the seat cushion when the lower legs hang over the edge of the seat cushion. You may wish to discuss the special needs of your child with your pediatrician.

### SAFETY SEATS FOR CHILDREN



## Seating and safety restraints

### Child and infant or child safety seats

Use a safety seat that is recommended for the size and weight of the child. Carefully follow all of the manufacturer's instructions with the safety seat you put in your vehicle. If you do not install and use the safety seat properly, the child may be injured in a sudden stop or collision.

When installing a child safety seat:

- Review and follow the information presented in the *Air Bag Supplemental Restraint System* section in this chapter.
- Use the correct safety belt buckle for that seating position.
- Insert the belt tongue into the proper buckle until you hear a snap and feel it latch. Make sure the tongue is securely fastened in the buckle.
- Keep the buckle release button pointing up and away from the safety seat, with the tongue between the child seat and the release button, to prevent accidental unbuckling.
- Place seat back in upright position.
- Put the safety belt in the automatic locking mode. Refer to *Automatic locking mode*.

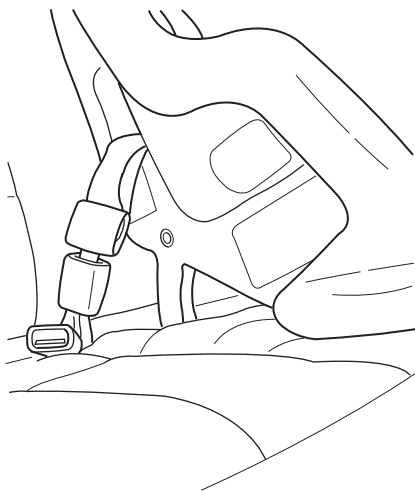

Ford recommends the use of a child safety seat having a top tether strap. Install the child safety seat in a seating position which is capable of providing a tether anchorage. For more information on top tether straps, refer to *Attaching safety seats with tether straps*.



Carefully follow all of the manufacturer's instructions included with the safety seat you put in your vehicle. If you do not install and use the safety seat properly, the child may be injured in a sudden stop or collision.

## Seating and safety restraints

### Installing child safety seats in combination lap and shoulder belt seating positions



Air bags can kill or injure a child in a child seat. **NEVER** place a rear-facing child seat in front of an active air bag. If you must use a forward-facing child seat in the front seat, move the seat all the way back.

1. Position the child safety seat in a seat with a combination lap and shoulder belt.

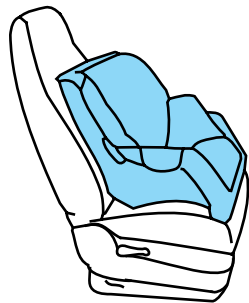

Children 12 and under should be properly restrained in the rear seat whenever possible.

2. Pull down on the shoulder belt and then grasp the shoulder belt and lap belt together.

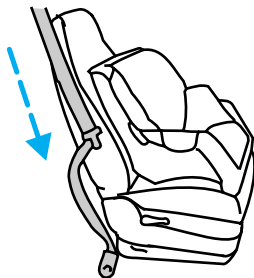

## Seating and safety restraints

3. While holding the shoulder and lap belt portions together, route the tongue through the child seat according to the child seat manufacturer's instructions. Be sure the belt webbing is not twisted.

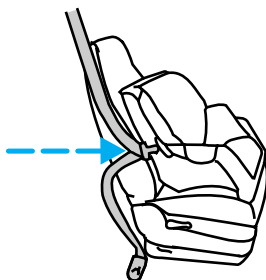

4. Insert the belt tongue into the proper buckle (the buckle closest to the direction the tongue is coming from) for that seating position until you hear a snap and feel the latch engage. Make sure the tongue is latched securely by pulling on it.

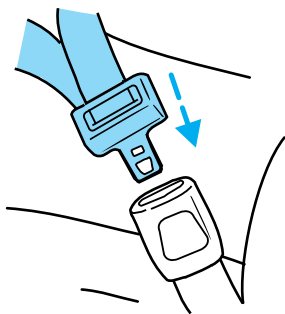

5. To put the retractor in the automatic locking mode, grasp the shoulder portion of the belt and pull downward until all of the belt is extracted and a click is heard.

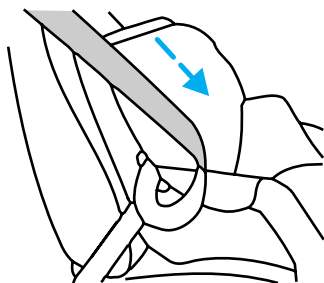

6. Allow the belt to retract. The belt will click as it retracts to indicate it is in the automatic locking mode.

## Seating and safety restraints

7. Pull the lap belt portion across the child seat toward the buckle and pull up on the shoulder belt while pushing down with your knee on the child seat.

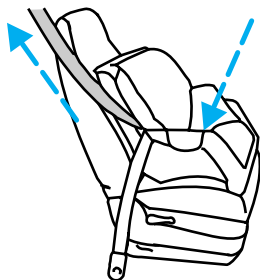

8. Allow the safety belt to retract to remove any slack in the belt.

9. Before placing the child in the seat, forcibly tilt the seat forward and back to make sure the seat is securely held in place.

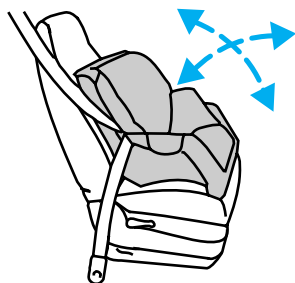

10. Try to pull the belt out of the retractor to make sure the retractor is in the automatic locking mode (you should not be able to pull more belt out). If the retractor is not locked, unbuckle the belt and repeat steps two through nine.

Check to make sure the child seat is properly secured before each use.

### Attaching child safety seats with tether straps

Most new forward-facing child safety seats include a tether strap which goes over the back of the seat and hooks to an anchoring point. Tether straps are available as an accessory for many older safety seats. Contact the manufacturer of your child seat for information about ordering a tether strap.

The rear seats of your vehicle are equipped with built-in tether strap anchors located behind the seats as described below.

The tether anchors in your vehicle are located under a cover marked with the tether anchor symbol (shown with title).

## Seating and safety restraints

The tether strap anchors in your vehicle are in the following positions (shown from top view):

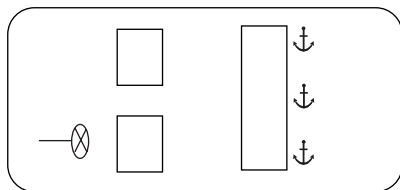

Attach the tether strap only to the appropriate tether anchor as shown. The tether strap may not work properly if attached somewhere other than the correct tether anchor.

1. Position the child safety seat on the seat cushion.
2. Route the child safety seat tether strap over the back of the seat. For vehicles with adjustable head restraints, route the tether strap under the head restraint and between the head restraint posts, otherwise route the tether strap over the top of the seatback.
3. Locate the correct anchor for the selected seating position.



4. Open the tether anchor cover.



## Seating and safety restraints

5. Clip the tether strap to the anchor as shown.



If the tether strap is clipped incorrectly, the child safety seat may not be retained properly in the event of a collision.

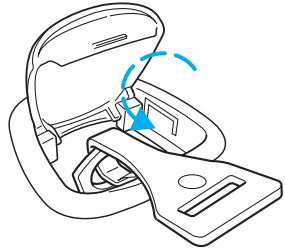

6. Refer to the *Installing child*

*safety seats in combination lap and shoulder belt seating positions* section of this chapter for further instructions to secure the child safety seat.

7. Tighten the child safety seat tether strap according to the manufacturer's instructions.



If the safety seat is not anchored properly, the risk of a child being injured in a collision greatly increases.

### Attaching child safety seats with Lower Anchor and Tethers for Children (LATCH) attachments for child seat anchors

Some child safety seats are labeled as LATCH or LATCH-compatible child seats. These seats include two rigid or webbing mounted attachments that connect to two anchors at specific seating positions in your vehicle. This type of child seat eliminates the need to use seat belts to attach the child seat. For forward-facing child seats, the tether strap must also be attached to the proper tether anchor point. For information on using tether straps with the child safety seats, refer to *Attaching safety seats with tether straps* in this chapter.

LATCH anchors for child seat installation have been provided in your vehicle at the following locations:

The anchors at the center of the rear seat are much further apart than the sets of lower anchors for child seat installation at other seating positions. A child seat with rigid LATCH attachments cannot be installed at this seating position. A LATCH compatible child seat (with attachments on belt webbing) can be

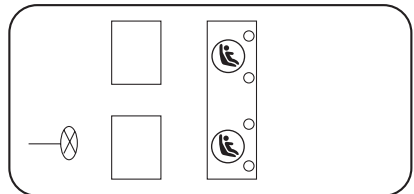



## Seating and safety restraints

used at this seating position only if the child seat instructions state that the child seat can be installed to anchors that are 500 mm apart. Do not attach a child seat to any lower anchor if an adjacent child seat is attached to that anchor.

 Do not attach a child seat to any lower anchors used for child seat installation if an adjacent child seat is attached to that anchor. In a crash, one anchor may not be strong enough to hold two child seat attachments and may break, causing serious injury or death.

The lower anchors for child seat installation are located at the rear section of the rear seat between the cushion and seat back. Each lower anchor for child seat installation is located 2–3 inches below the locator symbols.

Follow the child seat manufacturer's instructions to properly install safety seats with LATCH lower anchors and LATCH-compatible attachments. Two plastic LATCH guides may be obtained at no charge from any Ford or Lincoln Mercury dealer. They snap onto the latch lower anchor in the vehicle to help attach a child seat with rigid latch attachments. It will hold the seat foam away and expose the anchor making attachment of the child seat easier.

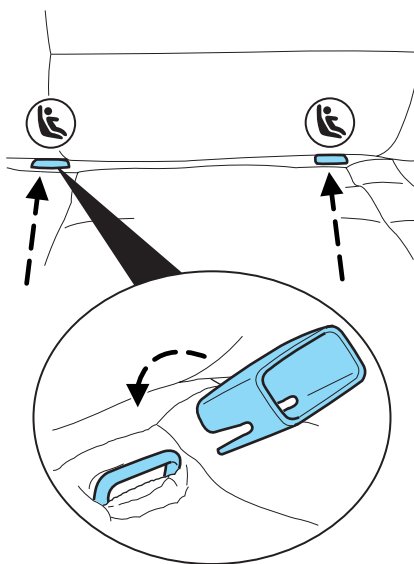

 Attach the lower anchors for child seat installation or lower anchors for child seat installation-compatible child seat only to the appropriate locations shown.

## Seating and safety restraints

If you install a child seat with rigid LATCH attachments, do not tighten the tether strap enough to lift the child seat off the seat when the child is seated in it. Keep the tether strap just snug without raising the front of the child seat. Keeping the child seat just touching the front of the vehicle seat gives the best protection in a severe crash. Once you have installed the lower anchors for child seat installation safety seat, assure that the seat is properly attached to the lower anchors for child seat installation and tether anchors. Also, test the safety seat before you place the child in it. Tilt the seat from side to side. Also try to tug the seat forward. Check to see if the anchors hold the seat in place.



If the safety seat is not anchored properly, the risk of a child being injured in a collision greatly increases.

## PREPARING TO START YOUR VEHICLE

Engine starting is controlled by the powertrain control system. This system meets all Canadian Interference-Causing Equipment standard requirements regulating the impulse electrical field strength of radio noise.

When starting a fuel-injected engine, avoid pressing the accelerator before or during starting. Only use the accelerator when you have difficulty starting the engine. For more information on starting the vehicle, refer to *Starting the engine* in this chapter.



Extended idling at high engine speeds can produce very high temperatures in the engine and exhaust system, creating the risk of fire or other damage.



Do not park, idle, or drive your vehicle in dry grass or other dry ground cover. The emission system heats up the engine compartment and exhaust system, which can start a fire.



Do not start your vehicle in a closed garage or in other enclosed areas. Exhaust fumes can be toxic. Always open the garage door before you start the engine. See *Guarding against exhaust fumes* in this chapter for more instructions.



If you smell exhaust fumes inside your vehicle, have your dealer inspect your vehicle immediately. Do not drive if you smell exhaust fumes.

## Important safety precautions

A computer system controls the engine's idle revolutions per minute (RPM). When the engine starts, the idle RPM runs faster to warm the engine. If the engine idle speed does not slow down automatically, have the vehicle checked. Do not allow the vehicle to idle for more than 10 minutes at high engine RPM.

Before starting the vehicle:

1. Make sure all vehicle occupants have buckled their safety belts. For more information on safety belts and their proper usage, refer to the *Seating and safety restraints* chapter.

## Starting

2. Make sure the headlamps and vehicle accessories are off.

If starting a vehicle with an automatic transmission:

- Make sure the parking brake is set.

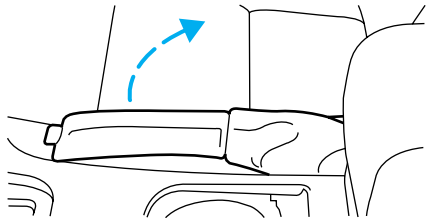

- Make sure the gearshift is in P (Park).

If starting a vehicle with a manual transmission:

- Make sure the parking brake is set.
- Push the clutch pedal to the floor.

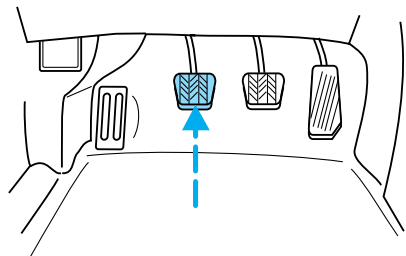

3. Turn the key to 4 (RUN) without turning the key to 5 (START).

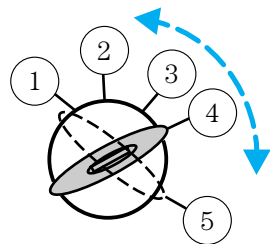

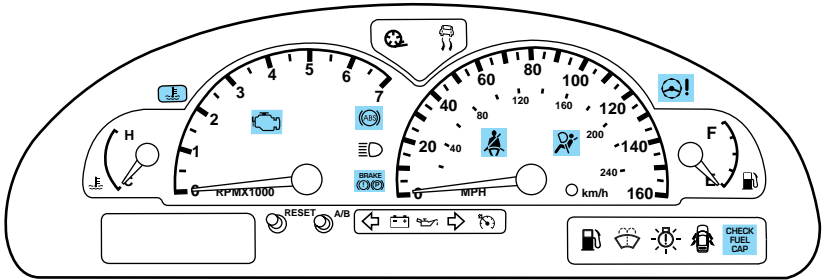

Make sure the corresponding lights illuminate or illuminate briefly. If a light fails to illuminate, have the vehicle serviced.

- If the driver's safety belt is fastened, the light may not illuminate.

## STARTING THE ENGINE



Whenever you start your vehicle, release the key as soon as the engine starts. Excessive cranking could damage the starter.

1. Turn the key to 5 (START) without pressing the accelerator pedal and release as soon as the engine starts. The key will return to 4 (RUN).

2. If the temperature is above  $-12^{\circ}\text{C}$  ( $10^{\circ}\text{F}$ ) and the engine does not start within five seconds on the first try, turn the key to OFF, wait 10 seconds and try again.

3. If the temperature is below  $-12^{\circ}\text{C}$  ( $10^{\circ}\text{F}$ ) and the engine does not start in 15 seconds on the first try, turn the key OFF and wait 10 seconds and try again. If the engine does not start in two attempts, Press the accelerator pedal all the way to floor and hold. Turn the key to START position.

4. When the engine starts, release the key, then release the accelerator pedal gradually as the engine speeds up.

5. After idling for a few seconds, apply the brake and release the parking brake.

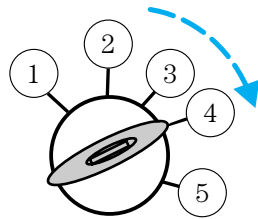

## Starting

### Using the engine block heater (if equipped)

An engine block heater warms the engine coolant, which improves starting, warms up the engine faster and allows the heater-defroster system to respond quickly. Use of an engine block heater is strongly recommended if you live in a region where temperatures reach  $-23^{\circ}\text{C}$  ( $-10^{\circ}\text{F}$ ) or below.

For best results, plug the heater in at least three hours before starting the vehicle. Using the heater for longer than three hours will not harm the engine, so the heater can be plugged in the night before starting the vehicle.



To prevent electrical shock, do not use your heater with ungrounded electrical systems or two-pronged (cheater) adapters.

### Guarding against exhaust fumes

Although odorless and colorless, carbon monoxide is present in exhaust fumes. Take precautions to avoid its dangerous effects.



If you ever smell exhaust fumes of any kind inside your vehicle, have your dealer inspect and fix your vehicle immediately. Do not drive if you smell exhaust fumes. These fumes are harmful and could kill you.

Have the exhaust and body ventilation systems checked whenever:

- the vehicle is raised for service.
- the sound of the exhaust system changes.
- the vehicle has been damaged in a collision.



**WARNING:** Engine exhaust, some of its constituents, and certain vehicle components contain or emit chemicals known to the State of California to cause cancer and birth defects or other reproductive harm. In addition, certain fluids contained in vehicles and certain products of component wear contain or emit chemicals known to the State of California to cause cancer and birth defects or other reproductive harm.

### **Important ventilating information**

If the engine is idling while the vehicle is stopped in an open area for long periods of time, open the windows at least 2.5 cm (one inch).

Adjust the heating or air conditioning (if equipped) to bring in fresh air.

Improve vehicle ventilation by keeping all air inlet vents clear of snow, leaves and other debris.

## Driving

### BRAKES

Your service brakes are self-adjusting. Refer to the scheduled maintenance guide for scheduled maintenance.

Occasional brake noise is normal and often does not indicate a performance concern with the vehicle's brake system. In normal operation, automotive brake systems may emit occasional or intermittent squeal or groan noises when the brakes are applied. Such noises are usually heard during the first few brake applications in the morning; however, they may be heard at any time while braking and can be aggravated by environmental conditions such as cold, heat, moisture, road dust, salt or mud. If a "metal-to-metal," "continuous grinding" or "continuous squeal" sound is present while braking, the brake linings may be worn-out and should be inspected by a qualified service technician.

### Anti-lock brake system (ABS)

On vehicles equipped with an anti-lock braking system (ABS), a noise from the hydraulic pump motor and pulsation in the pedal may be observed during ABS braking events. Pedal pulsation coupled with noise while braking under panic conditions or on loose gravel, bumps, wet or snowy roads is normal and indicates proper functioning of the vehicle's anti-lock brake system. The ABS performs a self-check after you start the engine and begin to drive away. A brief mechanical noise may be heard during this test. This is normal. If a malfunction is found, the ABS warning light will come on. If the vehicle has continuous vibration or shudder in the steering wheel while braking, the vehicle should be inspected by a qualified service technician.

The ABS operates by detecting the onset of wheel lockup during brake applications and compensates for this tendency. The wheels are prevented from locking even when the brakes are firmly applied. The accompanying illustration depicts the advantage of an ABS equipped vehicle (on bottom) to a non-ABS equipped vehicle (on top) during hard braking with loss of front braking traction.

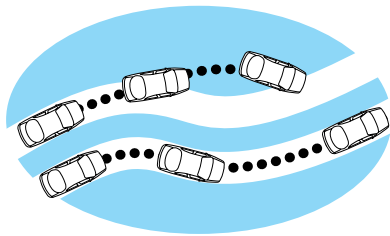

### ABS warning lamp (ABS)

The (ABS) warning lamp in the instrument cluster momentarily illuminates when the ignition is turned to the RUN position. If the light does not



illuminate momentarily at start up, remains on or continues to flash, the ABS needs to be serviced.

With the ABS light on, the anti-lock brake system is disabled and normal braking is still effective unless the brake warning light also remains illuminated with parking brake released. (If your brake warning lamp illuminates, have your vehicle serviced immediately.)

**BRAKE**

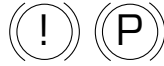

## Using ABS

- In an emergency or when maximum efficiency from the four wheel ABS is required, apply continuous force on the brake. The four wheel ABS will be activated immediately, thus allowing you to retain full steering control of your vehicle and, providing there is sufficient space, will enable you to avoid obstacles and bring the vehicle to a controlled stop.
- The Anti-Lock system does not decrease the time necessary to apply the brakes or always reduce stopping distance. Always leave enough room between your vehicle and the vehicle in front of you to stop.
- We recommend that you familiarize yourself with this braking technique. However, avoid taking any unnecessary risks.

## Parking brake (P)

Apply the parking brake whenever the vehicle is parked. To set the parking brake, apply the brake pedal and pull the handle up as far as possible.

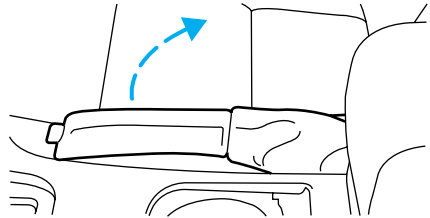

The BRAKE warning lamp in the instrument cluster illuminates and remains illuminated (when the ignition is turned to the RUN position) until the parking brake is released.

**BRAKE**

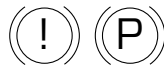

## Driving

The parking brake is not recommended to stop a moving vehicle. However, if the normal brakes fail, the parking brake can be used to stop your vehicle in an emergency. Since the parking brake applies only the rear brakes, the vehicle's stopping distance will increase greatly and the handling of your vehicle will be adversely affected.



Always set the parking brake fully and make sure that the gearshift is securely latched in P (Park) (automatic transmission) or in 1 (First) (manual transmission).

Your brake handle may need to be pulled up slightly to release pressure before pushing in the button.

Push the button on the end of the parking brake and push the handle down as far as possible to release the brake. Driving with the parking brake on will cause the brakes to wear out quickly and reduce fuel economy.

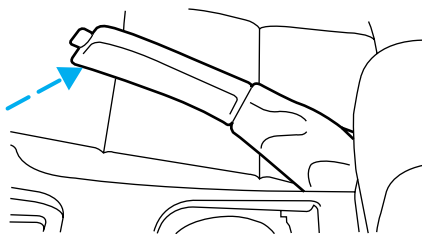

## STEERING

Your vehicle is equipped with power steering. Power steering uses energy from the engine to help steer the vehicle.

To prevent damage to the power steering pump:

- Never hold the steering wheel to the extreme right or the extreme left for more than a few seconds when the engine is running.
- Do not operate the vehicle with a low power steering pump fluid level (below the MIN mark on the reservoir).

If the power steering system breaks down (or if the engine is turned off), you can steer the vehicle manually, but it takes more effort.

If the steering wanders or pulls, the condition could be caused by any of the following:

- underinflated tire(s) on any wheel(s)
- uneven vehicle loading
- high crown in center of road
- high crosswinds

- wheels out of alignment
- loose or worn suspension components

### **Speed sensitive steering**

The steering in your vehicle is speed sensitive. At high speeds, steering assist will decrease to improve steering feel. At lower speeds, maneuverability will be increased.

If the amount of effort required to steer your vehicle changes while driving at a constant vehicle speed, have the power steering system checked by your dealer or a qualified service technician.

### **TRACTION CONTROL™**

The Traction Control™ system helps maintain the stability and steerability of your vehicle. It is especially useful on slippery and/or hilly road surfaces. The system operates at all speeds by detecting and controlling wheel spin. The system borrows many of the electronic and mechanical elements already present in the anti-lock braking system (ABS).

Wheel-speed sensors allow excess rear wheel spin to be detected by the Traction Control™ portion of the ABS computer. Any excessive wheel spin is controlled by automatically applying and releasing the rear brakes in conjunction with engine torque reductions. Engine torque reduction is realized via the fully electronic spark and fuel injection systems. This process is very sensitive to driving conditions and very fast acting. The rear wheels “search” for optimum traction several times a second and adjustments are made accordingly.

The Traction Control™ system will allow your vehicle to make better use of available traction on slippery surfaces. The system is a driver aid which makes your vehicle easier to handle primarily on snow and ice covered roads. This is especially evident if wheel spin-up should occur while turning.

During Traction Control™ operation you may hear an electric motor type of sound coming from the engine compartment and the engine will not “rev-up” when you push further on the accelerator. This is normal system behavior.

## Driving

If you should become stuck in snow or on a very slippery road surface, try switching the Traction Control™ system off. This may allow excess wheel spin to “dig” the vehicle out or enable a successful “rocking” maneuver.

If the Traction Control™ system is cycled excessively, the brake portion of the system will shut down to prevent the rear brakes from overheating. A limited Traction Control™ function using only engine torque reduction will still help control wheels from over-spinning. When the rear brakes have cooled down, the system will again function normally. Anti-lock braking is not affected by this condition and will function normally during the cool down period.

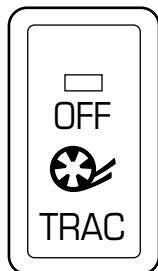

### **AdvanceTrac™ Stability Enhancement System (if equipped)**

The AdvanceTrac™ system helps the driver maintain the stability and steerability of the vehicle. The system integrates anti-lock braking system (ABS), Traction Control™ and a more advanced function to further enhance the stability of the vehicle. The system shares many of the electronic and mechanical elements already present in the Traction Control™ and ABS systems.

The AdvanceTrac™ constantly monitors the vehicle motion relative to the driver's intended course. This is done by using added sensors that compare the steering inputs from the driver with the actual motion of the vehicle. When there is a discrepancy between the driver's inputs and the vehicle motion, AdvanceTrac™ changes the force at each tire to help control the vehicle. If the vehicle begins to rotate excessively left or right, spin out, or slide sideways, the system will attempt to correct the excessive motion. If the vehicle does not respond to steering inputs, the system will attempt to increase the turning response of the vehicle.

The AdvanceTrac™ enhances stability during maneuvers that require all available tire traction to control the vehicle. The benefits of the AdvanceTrac™ system are most noticeable when driving in wet/snowy/icy road conditions and/or when performing emergency maneuvers. In an emergency lane-change, the driver will experience better overall vehicle traction, and have better control of the vehicle.

Driving conditions which may activate AdvanceTrac™ include:

- Taking a turn too fast
- Evasively maneuvering to avoid an accident, pedestrian or obstacle
- Hitting a patch of ice
- Changing lanes on a snow-rutted road
- Entering a snow-free road from a snow-covered side street
- Entering a paved road from a gravel road
- Hitting a curb while turning
- Driving on slick surfaces

The AdvanceTrac™ system defaults to ON when the engine is started. The system does not work when the vehicle is traveling backwards. In reverse, ABS and Traction Control™ will continue to function. The system uses ABS and Traction Control™ (including control of the engine) as well as its more advanced controls to enhance vehicle stability.

The AdvanceTrac™ on/off control button allows the driver to control the availability of the Traction Control™ and AdvanceTrac™ system. This is independent of the ABS function, which can **NOT** be switched off by the driver. The AdvanceTrac™ system status is indicated by a warning indicator light with a “sliding car” icon in the instrument cluster that will flash

when the system is active and an indicator light in the control button that will illuminate when the system is turned OFF. In vehicles with a message center (if equipped), the message “ADVANCETRAC OFF” is displayed. If a failure is detected in the AdvanceTrac™ system the warning indicator light in the instrument cluster will stay ON. If the warning indicator light in the instrument cluster remains ON while the engine is running, have the system serviced immediately.

The AdvanceTrac™ system continually monitors and checks all sensors used in improving the stability of the vehicle. Some drivers may notice a slight movement of the brake pedal when the system checks itself.

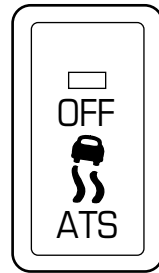

## Driving

During AdvanceTrac™ operation you may experience the following:

- A rumble or grinding sound much like ABS or Traction Control™
- A slight deceleration or a reduction in the acceleration of the vehicle
- The AdvanceTrac indicator light will flash
- If your foot is on the brake pedal, you will feel a vibration in the pedal much like ABS. As with any vehicle equipped with four-wheel ABS, do not pump the brakes, but instead, press firmly on the pedal.
- If the condition is severe and your foot is not on the brake, the brake pedal will move to apply higher brake forces. You may also hear a whoosh of air from under the instrument panel during this severe condition.

All these conditions are normal during AdvanceTrac™ operation.



Aggressive driving in any road conditions can cause you to lose control of your vehicle increasing the risk of severe personal injury or property damage. The occurrence of an AdvanceTrac™ event is an indication that at least some of the tires have exceeded their ability to grip the road and that you may lose control of the vehicle. If you experience a severe road event, SLOW DOWN.



If you find yourself regularly experiencing AdvanceTrac™ events, you are driving too fast for conditions, you should reduce your speed, and drive less aggressively. AdvanceTrac is limited by the laws of physics. It is always possible to lose control of a vehicle due to inappropriate driver inputs for the conditions. The occurrence of an AdvanceTrac™ event is an indication that at least some of the tires have exceeded their ability to grip the road; this may cause you to lose control of the vehicle increasing the risk of severe personal injury or property damage.

## AUTOMATIC TRANSMISSION OPERATION (IF EQUIPPED)

### Brake-shift interlock

This vehicle is equipped with a brake-shift interlock feature that prevents the gearshift lever from being moved from P (Park) when the ignition is in the RUN position unless brake pedal is depressed.

If you cannot move the gearshift lever out of P (Park) with ignition in the RUN position and the brake pedal depressed:

1. Apply the parking brake, turn ignition key to LOCK, then remove the key.
2. Insert the key and turn it to OFF. Apply the brake pedal and shift to N (Neutral).
3. Start the vehicle.

If it is necessary to use the above procedure to move the gearshift lever, it is possible that a fuse has blown or the vehicle's brakelamps are not operating properly. Refer to *Fuses and relays* in the *Roadside emergencies* chapter.



Do not drive your vehicle until you verify that the brakelamps are working.

If your vehicle gets stuck in mud or snow it may be rocked out by shifting from forward and reverse gears, stopping between shifts, in a steady pattern. Press lightly on the accelerator in each gear.

**Do not rock the vehicle if the engine is not at normal operating temperature or damage to the transmission may occur.**

**Do not rock the vehicle for more than a few minutes or damage to the transmission and tires may occur or the engine may overheat.**



Always set the parking brake fully and make sure the gearshift is latched in P (Park). Turn off the ignition whenever you leave your vehicle.



If the parking brake is fully released, but the brake warning lamp remains illuminated, the brakes may not be working properly. See your dealer or a qualified service technician.

### **Driving with a 5-speed automatic transmission (if equipped)**

Your automatic transmission electronically controls the shift feel by using an adaptive learning strategy. This feature is designed to increase durability, and provide consistent shift feel over the life of the vehicle. It is normal for a new transmission to shift firmly. This operation is

## Driving

considered normal and will not affect function durability of the transmission. Once the vehicle is at operating temperature it may take several shifts at the same operating condition for the transmission to properly adapt. Over time the adaptive learning process will fully update transmission operation. The more varied the driving habits, speed and torque, the longer it may take to adapt but the more complete the process will be.

When the battery is disconnected or a new battery installed, the transmission must learn its adaptive strategy. As a result of this, the transmission may shift firmly. This operation is considered normal and will fully update transmission operation to its optimum shift feel.

### ***Understanding gearshift positions***

Pull the gearshift lever towards you and downward to the desired gear. The gearshift positions are displayed on the floor console next to the gearshift lever and on the instrument cluster.



Hold the brake pedal down while you move the gearshift lever from P (Park) to another position. If you do not hold the brake pedal down, your vehicle may move unexpectedly and injure someone.

### ***P (Park)***

Always come to a complete stop before shifting into P (Park). Make sure the gearshift lever is securely latched in P (Park). This position locks the transmission and prevents the rear wheels from turning.



Always set the parking brake fully and make sure the gearshift lever is latched in P (Park). Turn off the ignition whenever you leave your vehicle.

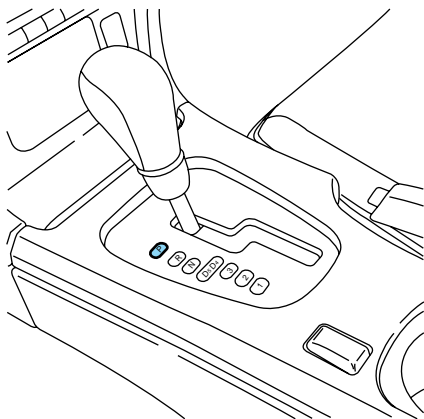



## **R (Reverse)**

With the gearshift lever in R (Reverse), the vehicle will move backward. Always come to a complete stop before shifting into and out of R (Reverse).

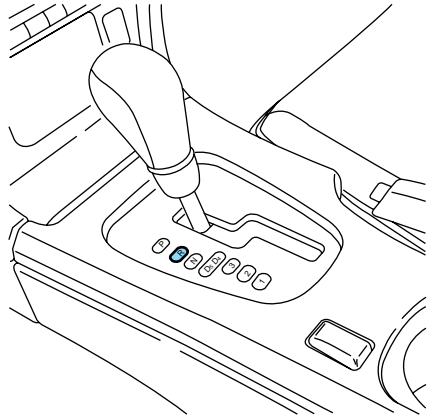

## **N (Neutral)**

With the gearshift lever in N (Neutral), the vehicle can be started and is free to roll. Hold the brake pedal down while in this gear.

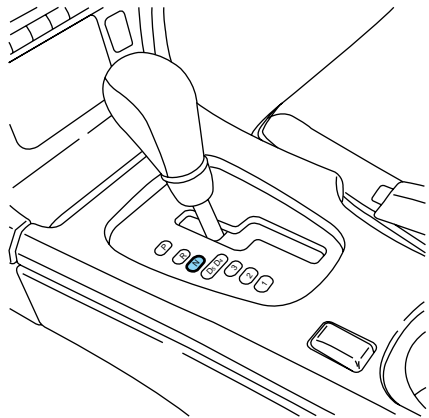

## Driving

### **Drive 5 (Overdrive)**

The normal driving position for the best fuel economy. Transmission operates in gears One through Five.

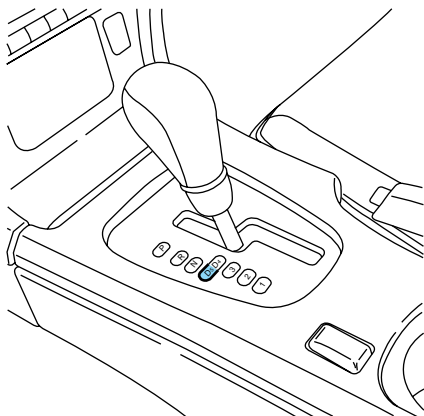

### **Drive 4 (Drive)**

Transmission operates in gears One through Four. Drive 4 (Drive) provides engine braking in 4th gear and is useful when:

- driving with a heavy load.
- towing a trailer up or down steep hills.
- additional engine downhill braking is desired. If towing a trailer, refer to *Driving while you tow* in the *Trailer Towing* section of this chapter.

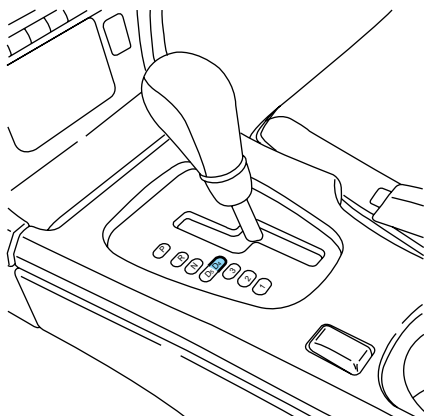

Upshifts into Overdrive can be made by shifting to D5. Selecting 4 (Drive) at higher speeds causes the transmission to shift to 4th gear. Selecting D4 from lower speeds will cause the transmission to upshift at the proper speed.

## **3 (Third)**

Transmission operates in third gear only. Selecting 3 (Third) provides engine braking.

Upshifts can be made by shifting to 4 (Drive) or 5 (Overdrive). Selecting 3 (Third) at higher speeds causes the transmission to shift to a lower gear, and will shift to 3 (Third) after vehicle decelerates to the proper speed.

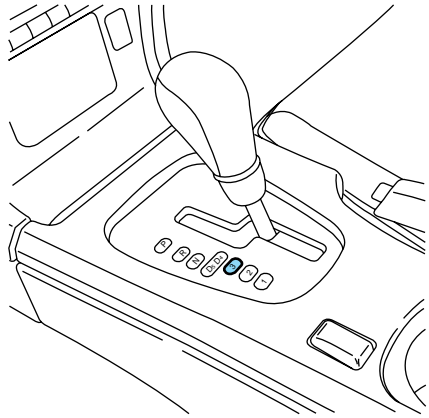

## **2 (Second)**

Use 2 (Second) to start-up on slippery roads or to provide additional engine braking on downgrades.

Upshifts can be made by shifting to 3 (Third), 4 (Drive) or 5 (Overdrive). Selecting 2 (Second) at higher speeds causes the transmission to shift to a lower gear, and will shift to 2 (Second) after vehicle decelerates to the proper speed.

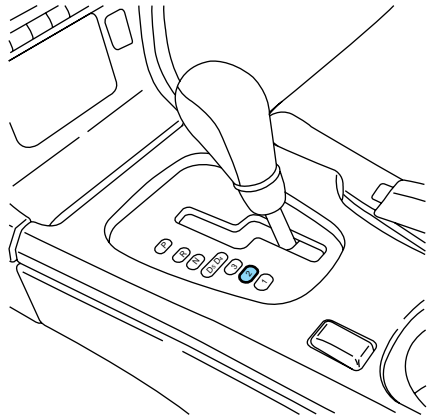

## Driving

### 1 (First)

Use 1 (Low) to provide maximum engine braking on steep downgrades.

Upshifts can be made by shifting to 2 (Second), 3 (Third), 4 (Drive) or 5 (Overdrive). Selecting 1 (Low) at higher speeds causes the transmission to shift to a lower gear, and will shift to 1 (Low) after vehicle decelerates to the proper speed.

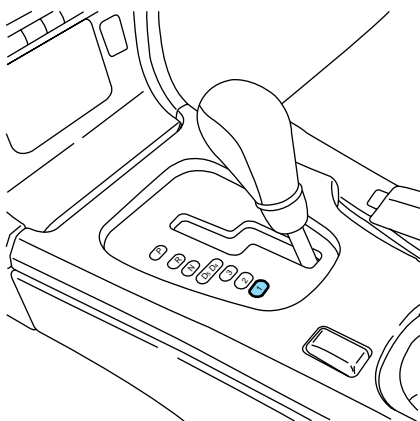

### ***Driving with a 5-speed automatic transmission with the Select Shift Transmission (SST) Shifter (if equipped)***

Your automatic transmission electronically controls the shift feel by using an adaptive learning strategy. This feature is designed to increase durability, and provide consistent shift feel over the life of the vehicle. It is normal for a new transmission to shift firmly. This operation is considered normal and will not affect function or durability of the transmission. Once the vehicle is at operating temperature it may take several shifts at the same operating condition for the transmission to properly adapt. Over time the adaptive learning process will fully update transmission operation. The more varied the driving habits, speed and torque, the longer it may take to adapt but the more complete the process will be.

When the battery is disconnected or a new battery installed, the transmission must relearn its adaptive strategy. As a result of this, the transmission may shift firmly. This operation is considered normal and will not affect function or durability of the transmission. Over time the adaptive learning process will fully update transmission operation to its optimum shift feel.

## **Understanding gearshift positions**

The Select Shift Transmission (SST) Shifter allows the driver to select between the transmission's automatic shift mode or the manually selected shift mode.

### **Automatic shift mode**

When in the automatic shift mode (D5 position), the 5-speed automatic transmission operates like a typical automatic transmission. Pull the gearshift lever towards you and downward to move the automatic gearshift.

Refer to *Driving with a 5-speed automatic transmission* in this chapter for Park, Reverse, Neutral, D5 and D4 information.

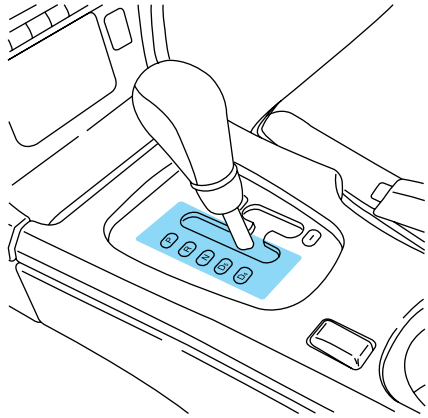

### **Manual shift mode**

With the gearshift lever in D5 (Overdrive), the gearshift lever can be moved to the right and into the manual shift mode. The transmission will remain in the manual shift mode until the gearshift lever is moved back to D5 (Overdrive).

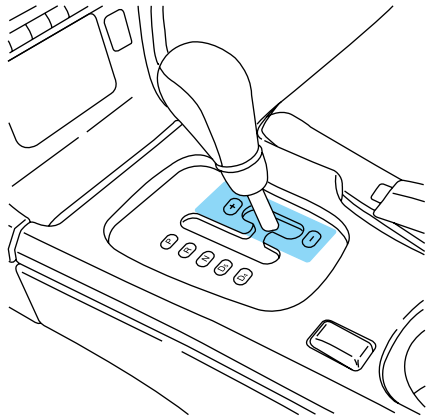

## Driving

### **+ and - position operation**

These positions allow the driver to manually select the appropriate upshift (+) or downshift (-) and gear range.

- Can only be entered from the D5 (Overdrive) shift position.
- Gear ranges 1–5 provide the same function and ratio as found in the D5 or D4 automatic mode positions.
- The transmission will not upshift or downshift unless the gearshift lever is moved forward or rearward.
- One tap forward (+) will **command** the transmission to upshift one gear range.
- One tap rearward (-) will **command** the transmission to downshift one gear range.
- Upshifts are allowed at any vehicle speed.
- 2 (Second) gear is normally used for start-up. A 3 (Third) gear start-up will be allowed only if selected. All other selection(s) will revert to 2 (Second) gear.
- If the driver starts in 2 (Second) gear and does not pass a throttle angle of 60%, the transmission will remain in 2 (Second) gear. No automatic upshift will occur.
- If the driver passes the 60% throttle angle, a 2–1 kickdown will occur, scheduled by the processor as used in D5. Once the 2–1 kickdown has occurred, the transmission will remain in 1 (First) gear until 2 (Second) gear is manually selected by moving the gearshift lever. No automatic upshift will occur.
- Once a 2–1 kickdown has occurred, manually shifting in and out of 1 (First ) gear is allowed until the vehicle comes to a complete stop.
- A shift to 1 (First) with the vehicle at a stop is never allowed.
- When downshifting at normal road speeds, the transmission will only allow a downshift into the **next lower** gear.
- If the gearshift lever is moved into the downshift (-) position more than once in rapid succession, the transmission will only allow a downshift into the **next lower** gear to prevent possible engine and/or transmission damage. Once the vehicle reaches below a specified entry

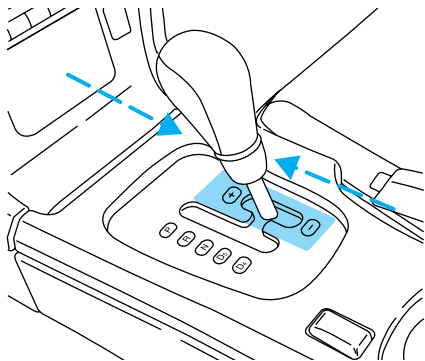

speed for the next lower gear, the transmission will allow another downshift to occur if selected by the driver.

## **Recommended Shift Speeds**

Upshift according to the following charts:

<b>Recommended upshifts when accelerating</b>	
<b>Select Shift V6 3.0L</b>	
Shift from:	
1 - 2	n/a
2 - 3	39 km/h (24 mph)
3 - 4	56 km/h (35 mph)
4 - 5	69 km/h (43 mph)

<b>Recommended upshifts when cruising</b>	
<b>Select Shift V6 3.0L</b>	
Shift from:	
1 - 2	n/a
2 - 3	29 km/h (18 mph)
3 - 4	50 km/h (31 mph)
4 - 5	64 km/h (40 mph)

<b>Recommended upshifts when accelerating</b>	
<b>Select Shift V8 3.9L</b>	
Shift from:	
1 - 2	n/a
2 - 3	34 km/h (21 mph)
3 - 4	51 km/h (32 mph)
4 - 5	66 km/h (41 mph)

<b>Recommended upshifts when cruising</b>	
<b>Select Shift V8 3.9L</b>	
Shift from:	
1 - 2	n/a
2 - 3	26 km/h (16 mph)
3 - 4	47 km/h (29 mph)
4 - 5	61 km/h (38 mph)

# Driving

## MANUAL TRANSMISSION OPERATION (IF EQUIPPED)

### Using the clutch

Vehicles equipped with a manual transmission have a starter interlock that prevents cranking the engine unless the clutch pedal is fully depressed.

When starting a vehicle with a manual transmission, you must:

1. Make sure the parking brake is fully set.
2. Depress the clutch pedal fully.
3. Put the gearshift lever in N (Neutral).

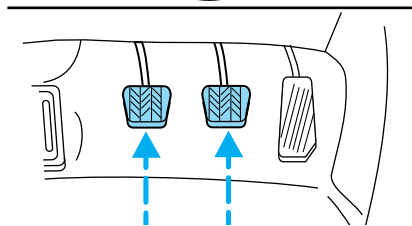
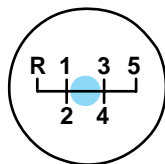

4. Turn the ignition to position 5 (START) to start the engine, let the engine idle for a few seconds.

5. Depress the brake pedal.
6. Release the parking brake.
7. Move the gearshift lever to the desired gear.

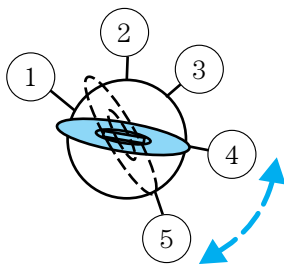

8. Release the brake pedal.
9. Slowly release the clutch pedal while slowly pressing down on the accelerator pedal.

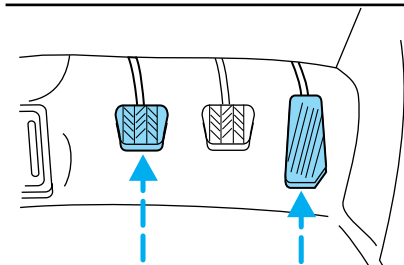



- Do not drive with your foot resting on the clutch pedal and do not use the clutch to hold your vehicle at a standstill while waiting on a hill. These actions will greatly reduce clutch life.

## Recommended shift speeds

Upshift according to the following chart:

Recommended upshifts when accelerating	
5-speed manual transmission	
Shift from:	
1 - 2	24 km/h (15 mph)
2 - 3	45 km/h (28 mph)
3 - 4	60 km/h (37 mph)
4 - 5	82 km/h (51 mph)

Recommended upshifts when cruising	
5-speed manual transmission	
Shift from:	
1 - 2	18 km/h (11 mph)
2 - 3	32 km/h (20 mph)
3 - 4	51 km/h (32 mph)
4 - 5	68 km/h (42 mph)

## Parking your vehicle

- Disengage the clutch, apply brake and shift into N (Neutral).

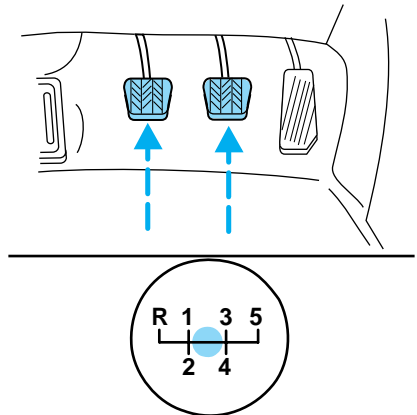

## Driving

2. Set parking brake.
3. Shift into 1 (First).

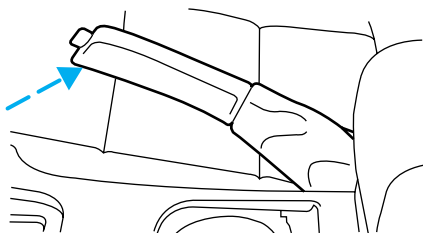

4. Turn the ignition key to position 1 (LOCK).

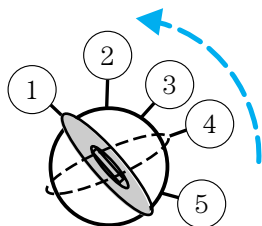

Do not park your vehicle in Neutral, it may move unexpectedly and injure someone. Use 1 (First) gear and set the parking brake fully.

## Reverse

Make sure that your vehicle is at a complete stop before you shift into R (Reverse). Failure to do so may damage the transmission.

Put the gearshift lever in N (Neutral) and wait at least three seconds before shifting into R (Reverse).

Shift into R (Reverse) only by moving the gearshift lever left of 1 (First) gear and then forward into R (Reverse) gear.

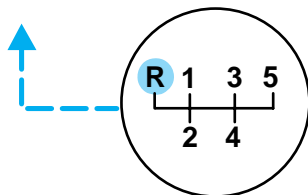

## Removing key from ignition

- Turn the ignition key to position 1 (LOCK).
- Remove the ignition key.

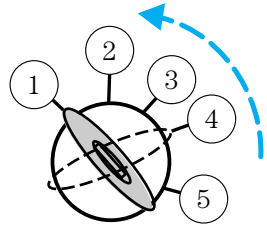

## DRIVING THROUGH WATER

Do not drive quickly through standing water, especially if the depth is unknown. Traction or brake capability may be limited and if the ignition system gets wet, your engine may stall. Water may also enter your engine's air intake and severely damage your engine.

If driving through deep or standing water is unavoidable, proceed very slowly. Never drive through water that is higher than the bottom of the hubs (for trucks) or the bottom of the wheel rims (for cars).

Once through the water, always try the brakes. Wet brakes do not stop the vehicle as effectively as dry brakes. Drying can be improved by moving your vehicle slowly while applying light pressure on the brake pedal.

**Driving through deep water where the transmission vent tube is submerged may allow water into the transmission and cause internal transmission damage.**

## VEHICLE LOADING

Before loading a vehicle, familiarize yourself with the following terms:

- **Base Curb Weight:** Weight of the vehicle including any standard equipment, fluids, lubricants, etc. It does not include passengers or aftermarket equipment.
- **Payload:** Combined maximum allowable weight of cargo, passengers and optional equipment. The payload equals the gross vehicle weight rating minus base curb weight.
- **GVW (Gross Vehicle Weight):** Base curb weight plus payload weight. The GVW is not a limit or a specification.

## Driving

- **GVWR (Gross Vehicle Weight Rating):** Maximum total weight of the base vehicle, passengers, optional equipment and cargo. The GVWR is specific to each vehicle and is listed on the Safety Certification Label on the driver's door pillar.
- **GAWR (Gross Axle Weight Rating):** Carrying capacity for each axle system. The GAWR is specific to each vehicle and is listed on the Safety Certification Label on the driver's door pillar.
- **GCW (Gross Combined Weight):** The combined weight of the towing vehicle (including passengers and cargo) and the trailer.
- **GCWR (Gross Combined Weight Rating):** Maximum combined weight of towing vehicle (including passengers and cargo) and the trailer. The GCWR indicates the maximum loaded weight that the vehicle is designed to tow.
- **Maximum Trailer Weight Rating:** Maximum weight of a trailer the vehicle is permitted to tow. The maximum trailer weight rating is determined by subtracting the vehicle curb weight for each engine/transmission combination, any required option weight for trailer towing and the weight of the driver from the GCWR for the towing vehicle.
- **Maximum Trailer Weight:** Maximum weight of a trailer the loaded vehicle (including passengers and cargo) is permitted to tow. It is determined by subtracting the weight of the loaded trailer towing vehicle from the GCWR for the towing vehicle.
- **Trailer Weight Range:** Specified weight range that the trailer must fall within that ranges from zero to the maximum trailer weight rating.

Remember to figure in the tongue load of your loaded trailer when figuring the total weight.



Do not exceed the GVWR or the GAWR specified on the certification label.

Do not use replacement tires with lower load carrying capacities than the originals because they may lower the vehicle's GVWR and GAWR limitations. Replacement tires with a higher limit than the originals do not increase the GVWR and GAWR limitations.

The Safety Certification Label, found on the driver's door pillar, lists several important vehicle weight rating limitations. Before adding any additional equipment, refer to these limitations. If you are adding weight

to the front of your vehicle, (potentially including weight added to the cab), the weight added should not exceed the front axle reserve capacity (FARC). Additional frontal weight may be added to the front axle reserve capacity provided you limit your payload in other ways (i.e. restrict the number of passengers or amount of cargo carried).

Always ensure that the weight of passengers, cargo and equipment being carried is within the weight limitations that have been established for your vehicle including both gross vehicle weight and Front and rear gross axle weight rating limits. Under no circumstance should these limitations be exceeded. Exceeding any vehicle weight rating limitation could result in serious damage to the vehicle and/or personal injury.

### **TRAILER TOWING**

Trailer towing with your vehicle may require the use of a trailer tow option package.

Trailer towing puts additional loads on your vehicle's engine, transmission, axle, brakes, tires, and suspension. For your safety and to maximize vehicle performance, be sure to use the proper equipment while towing.

Follow these guidelines to ensure safe towing procedure:

- Stay within your vehicle's load limits. If exceeded, cargo should be removed from the trailer and/or the vehicle until all weights are within specified limits.
- Thoroughly prepare your vehicle for towing. Refer to *Preparing to tow* in this chapter.
- Use extra caution when driving while trailer towing. Refer to *Driving while you tow* in this chapter.
- Service your vehicle more frequently if you tow a trailer. Refer to the severe duty schedule in the scheduled maintenance guide.
- Do not tow a trailer until your vehicle has been driven at least 800 km (500 miles).
- Refer to the instructions included with towing accessories for the proper installation and adjustment specifications.

To ensure that the electrical system is not damaged, you will require a trailer tow package which includes a trailer tow module and the necessary wiring to connect the trailer tow module to the electrical system and to the trailer. This option is available through your dealer or through Ford Customer Service Division. Please refer to *Preparing to tow* for further information.

## Driving

Engine	Maximum GCWR - kg (lbs.)	Trailer weight range (0 - maximum) - kg (lbs.)
3.0L	0-2 885 (0-6 361)	0-455 (0-1 003)
3.9L	0-2 925 (0-6 450)	0-455 (0-1 003)
3.0L with Sport Package	0-2 915 (0-6 426)	0-907 (0-2 000)
3.9L with Sport Package	0-2 950 (0-6 504)	0-907 (0-2 000)

Do not exceed the maximum loads listed on the Certification label. For load specification terms found on the label, refer to *Vehicle loading* in this chapter. Remember to figure in the tongue load of your loaded trailer when figuring the total weight.



Towing trailers beyond the maximum recommended gross trailer weight exceeds the limit of the vehicle and could result in engine damage, transmission damage, structural damage, loss of control and personal injury.

### Preparing to tow

Use the proper equipment for towing a trailer, and make sure it is properly attached to your vehicle. See your dealer or a reliable trailer dealer if you require assistance.

### Hitches

Do not use hitches that clamp onto the vehicle bumper. Use a load carrying hitch. You must distribute the load in your trailer so that 10% of the total weight of the trailer is on the tongue.

### Safety chains

Always connect the trailer's safety chains to the frame or hook retainers of the vehicle hitch. To connect the trailer's safety chains, cross the chains under the trailer tongue and allow slack for turning corners.

If you use a rental trailer, follow the instructions that the rental agency gives to you.

**Do not attach safety chains to the bumper.**

## **Trailer brakes**

Electric brakes and manual, automatic or surge-type trailer brakes are safe if installed properly and adjusted to the manufacturer's specifications. The trailer brakes must meet local and Federal regulations.



Do not connect a trailer's hydraulic brake system directly to your vehicle's brake system. Your vehicle may not have enough braking power and your chances of having a collision greatly increase.

The braking system of the tow vehicle is rated for operation at the GVWR not GCWR.

## **Trailer lamps**

Trailer lamps are required on most towed vehicles. Ensure that your trailer lamps conform to local and Federal Regulations.

### **Do not splice or modify the vehicle electrical wiring or lamps for trailer towing.**

Your vehicle uses an advanced electronic module with ground side switching to control and monitor your vehicle lamps. Splicing into the wiring or attaching wiring to the vehicle bulbs will **DISABLE** the rear vehicle lamps from functioning. Your lamp outage feature will also be disabled or provide incorrect information.

Your vehicle is ready to install a Trailer Tow module that will provide the proper communication with the vehicle electrical system so your trailer lamps will function properly. See your dealer or trailer rental agency for proper instructions and equipment for hooking up trailer lamps.

## **Driving while you tow**

When towing a trailer:

- Ensure that you turn off your speed control. The speed control may shut off automatically when you are towing on long, steep grades.
- Consult your local motor vehicle speed regulations for towing a trailer.
- Shift out of D5 (Overdrive) and into D4 (Drive) or a lower gear when towing up or down steep hills. This will eliminate excessive downshifting and upshifting for optimum fuel economy and transmission cooling.
- Anticipate stops and brake gradually.

# Driving

## ***Servicing after towing***

If you tow a trailer for long distances, your vehicle will require more frequent service intervals. Refer to your scheduled maintenance guide for more information.

## **Trailer towing tips**

- Practice turning, stopping and backing up before starting on a trip to get the feel of the vehicle trailer combination. When turning, make wider turns so the trailer wheels will clear curbs and other obstacles.
- Allow more distance for stopping with a trailer attached.
- The trailer tongue weight should be 10% of the loaded trailer weight.
- After you have traveled 80 km (50 miles), thoroughly check your hitch, electrical connections and trailer wheel lug nuts.
- When stopped in traffic for long periods of time in hot weather, place the gearshift in P (Park) and increase idle speed. This aids engine cooling and air conditioner efficiency.
- Vehicles with trailers should not be parked on a grade. If you must park on a grade, place wheel chocks under the trailer's wheels.

## **Recreational towing (all wheels on the ground)**

Follow these guidelines for your specific powertrain combination to tow your vehicle with all four wheels on the ground (such as behind a recreational vehicle).

These guidelines are designed to ensure that your transmission is not damaged due to insufficient lubrication.

### **All Rear Wheel Drive (RWD) vehicles**

This applies to all cars and 4x2 trucks/sport utilities with rear wheel drive capability.

An example of recreational towing is towing your vehicle behind a Motorhome. The following recreational towing guidelines are designed to ensure that your transmission is not damaged.

- Place the transmission in N (Neutral).
- Maximum speed is 56 km/h (35 mph).
- Maximum distance is 80 km (50 miles).



If a distance of 80 km (50 miles) or a speed of 56 km/h (35 mph) must be exceeded, you must disconnect the driveshaft. Ford recommends the driveshaft be removed/installed only by a qualified technician. See your local dealer for driveshaft removal/installation.

**Improper removal/installation of the driveshaft can cause transmission fluid loss, damage to the driveshaft and internal transmission components.**

### **LUGGAGE RACK (IF EQUIPPED)**

The luggage rack is dealer installed only. See your local Lincoln Mercury dealership.

The maximum load is 75 kg (165 lb) on the luggage rack structure. The vehicle's roof panel is not designed to carry a load.

When loading the luggage rack, it is recommended to evenly distribute the load, as well as maintain a low center of gravity. Ensure that the load is securely fastened.

## Roadside emergencies

### GETTING ROADSIDE ASSISTANCE

To fully assist you should you have a vehicle concern, Ford offers a complimentary roadside assistance program. This program is separate from the New Vehicle Limited Warranty. The service is available:

- 24-hours, seven days a week
- for the Basic warranty period (Canada) or New Vehicle Limited Warranty period (U.S.) of three years or 60 000 km (36 000 miles), whichever comes first on Ford and Mercury vehicles, and four years or 80 000 km (50 000 miles) on Lincoln vehicles

Roadside assistance will cover:

- changing a flat tire
- jump-starts
- lock-out assistance
- fuel delivery
- towing of your disabled vehicle up to 56.3 kms (35 miles) from the point of pickup (this can include to the nearest Ford dealership, or your selling dealer if within the specified distance.) One tow per disablement. Even non-warranty related tows, like accidents or getting stuck in the mud or snow, are covered (some exclusions apply, such as impound towing or repossession).

### Using roadside assistance

Complete the roadside assistance identification card and place it in your wallet for quick reference. In the United States, this card is found in the Owner Guide portfolio in the glove compartment in Ford vehicles and is mailed to you if you own a Mercury or Lincoln. In Canada, the card is found in the Roadside Assistance book in the glove compartment.

To receive roadside assistance in the United States for Ford or Mercury vehicles, call 1-800-241-3673 or if you own a Lincoln vehicle, call 1-800-521-4140. In Canada call 1-800-665-2006.

Should you need to arrange roadside assistance for yourself, Ford will reimburse a reasonable amount. To obtain information about reimbursement, call 1-800-241-3673 in the United States for Ford or Mercury vehicles; or if you own a Lincoln vehicle, call 1-800-521-4140. Call 1-800-665-2006 in Canada.

# Roadside emergencies

## Roadside coverage beyond basic warranty

In the United States, you may purchase additional roadside assistance coverage beyond this period through the Ford Auto Club by contacting your Ford or Lincoln Mercury dealer.

Similarly in Canada, you may purchase additional coverage beyond the basic coverage period by consulting the Ford Roadside Assistance Club brochure or by calling 1-877-294-CLUB (1-877-294-2582).

## HAZARD FLASHER

Use only in an emergency to warn traffic of vehicle breakdown, approaching danger, etc. The hazard flashers can be operated when the ignition is off.

- The hazard lights control is located on top of the steering column.
- Depress hazard lights control to activate all hazard flashers simultaneously.
- Depress control again to turn the flashers off.

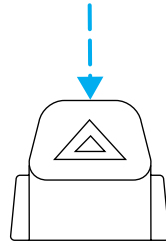

## RESETTING THE FUEL PUMP SHUT-OFF SWITCH

The fuel pump shut-off switch is a device intended to stop the electric fuel pump when your vehicle has been involved in a substantial jolt.

After a collision, if the engine cranks but does not start, the fuel pump shut-off switch may have been activated.

## Roadside emergencies

The fuel pump shut-off switch is located in the driver's foot well, behind the kick panel. The reset button (RED) for the fuel pump shut-off switch is accessible through an opening in the kick panel.

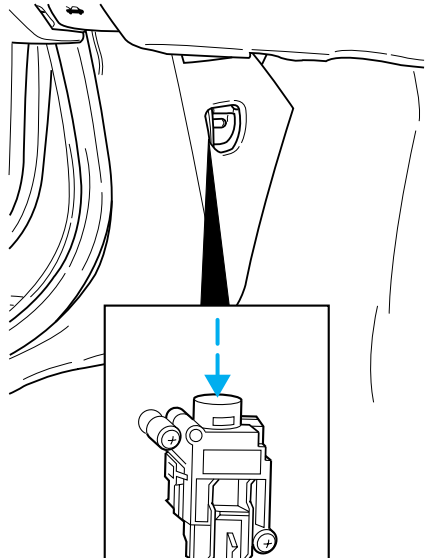

Use the following procedure to reset the fuel pump shut-off switch.

1. Turn the ignition to the OFF position.
2. Check the fuel system for leaks.
3. If no fuel leak is apparent, reset the fuel pump shut-off switch by pushing in on the reset button.
4. Turn the ignition to the RUN position. Pause for a few seconds and return the key to the OFF position.
5. Make a further check for leaks in the fuel system.

## FUSES AND RELAYS

### Fuses

If electrical components in the vehicle are not working, a fuse may have blown. Blown fuses are identified by a broken wire within the fuse. Check the appropriate fuses before replacing any electrical components.

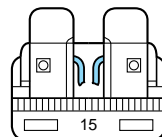

## Roadside emergencies



Always replace a fuse with one that has the specified amperage rating. Using a fuse with a higher amperage rating can cause severe wire damage and could start a fire.

### **Standard fuse amperage rating and color**

COLOR					
Fuse Rating	Mini Fuses	Standard Fuses	Maxi Fuses	Cartridge Maxi Fuses	Fuse Link Cartridge
2A	Grey	Grey	—	—	—
3A	Violet	Violet	—	—	—
4A	Pink	Pink	—	—	—
5A	Tan	Tan	—	—	—
7.5A	Brown	Brown	—	—	—
10A	Red	Red	—	—	—
15A	Blue	Blue	—	—	—
20A	Yellow	Yellow	Yellow	Blue	Blue
25A	Natural	Natural	—	—	—
30A	Green	Green	Green	Pink	Pink
40A	—	—	Orange	Green	Green
50A	—	—	Red	Red	Red
60A	—	—	Blue	—	Yellow
70A	—	—	Tan	—	Brown
80A	—	—	Natural	—	Black

### **Passenger compartment fuse panel**

The fuse panel is located on the right hand side kick panel. Remove the panel cover to access the fuses.

To remove a fuse use the fuse puller tool provided on the fuse panel cover.

## Roadside emergencies

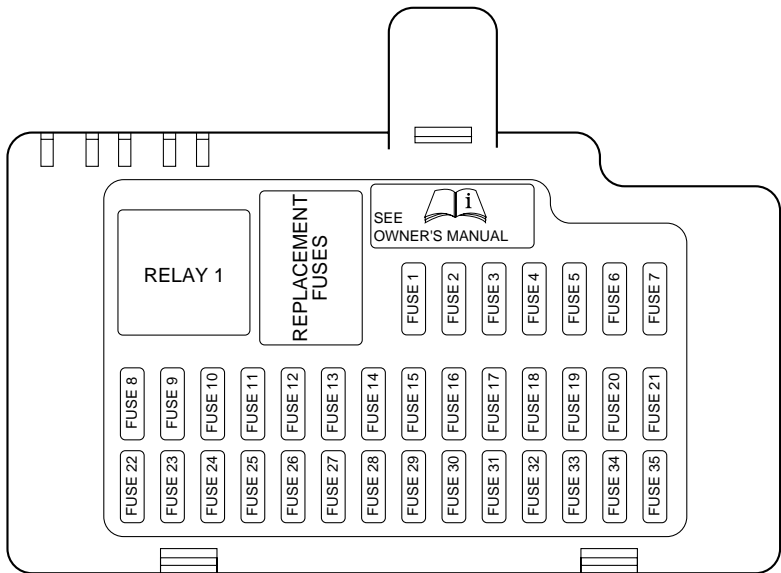

The fuses are coded as follows.

Fuse/Relay Location	Fuse Amp Rating	Passenger Compartment Fuse Panel Description
1	5A	Starter Relay Coil
2	5A	Radio
3	5A	ABS/TCS/AdvanceTrac
4	5A	Cluster, PCM Relay, Fuel Pump Relay, REM, Transit Relay
5	5A	T/A Switch, O/D Cancel Switch, Autolamp Sensor, Heated Seat Modules
6	10A	OBD II
7	5A	DDM, DSM, Anti-theft LED, Security Horn, PCM, Power Mirror
8	5A	Right Front Turn, Right Front Repeater, Right Front Sidemarker, Right Front Park Lamps

## Roadside emergencies

<b>Fuse/Relay Location</b>	<b>Fuse Amp Rating</b>	<b>Passenger Compartment Fuse Panel Description</b>
9	10A	Right Front Low Beam
10	5A	Left Front Turn, Left Front Repeater, Left Front Sidemarker, Left Front Park Lamps
11	10A	Left Front High Beam
12	—	Not Used
13	5A	Cluster
14	10A	RCM, DATC
15	5A	Not Used (Spare)
16	5A	E/C Mirror, Heated Seat Controls, RSM (Rain Sensor Module)
17	5A	RCM, Alternator Warning Lamp
18	20A	Radio, CIA
19	15A	Tilt/Tele Motors
20	10A	FEM, DATC, Cluster, Brake Shift Interlock, REM
21	10A	Power Folding Mirrors
22	10A	DDM
23	10A	Right Front High Beam
24	5A	PATS
25	10A	Left Front Low Beam
26	10A	Wiper Relay, Windshield Washer
27	10A	Radio, Cellphone
28	5A	Security Horn
29	5A	Trailer Tow Ignition Sense, VEMS, FEM
30	5A	FEM
31	—	Not Used
32	20A	Cigar Lighter
33	10A	Switch Backlighting
34	10A	Not Used (Spare)
35	5A	Stop Lamp Signal

## Roadside emergencies

### Front power distribution box

The front power distribution box is located in the engine compartment. The power distribution box contains high-current fuses that protect your vehicle's main electrical systems from overloads.

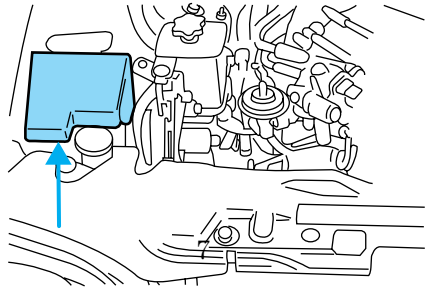

Always disconnect the battery before servicing high current fuses.



Always replace the cover to the Power Distribution Box before reconnecting the battery or refilling fluid reservoirs.

If the battery has been disconnected and reconnected, refer to the *Battery* section of the *Maintenance and care* chapter.



## Roadside emergencies

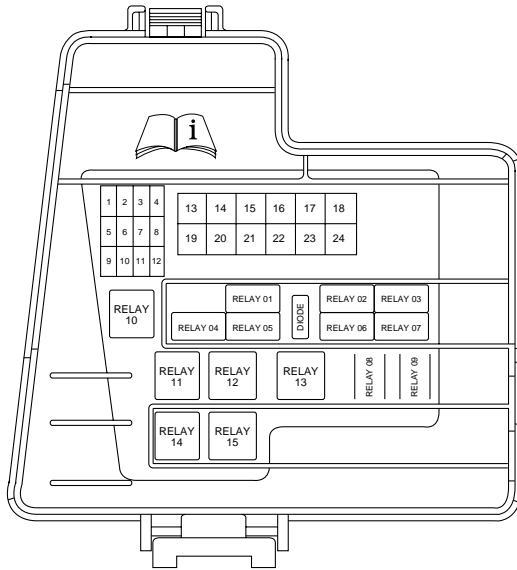

The high-current fuses are coded as follows.

Fuse/Relay Location	Fuse Amp Rating	Power Distribution Box Description
1	10A*	A/C Clutch
2	—	Not Used
3	15A*	Fog Lamp
4	15A*	Horn
5	20A*	Fuel Injectors
6	15A*	Transmission Solenoid
7	—	Not Used
8	—	Not Used
9	—	Not Used
10	—	Not Used
11	15A*	HEGO's
12	10A*	COP's

## Roadside emergencies

<b>Fuse/Relay Location</b>	<b>Fuse Amp Rating</b>	<b>Power Distribution Box Description</b>
13	30A**	Heated Wiper Park
14	30A**	ABS Module
15	—	Not Used
16	30A**	Blower Motor
17	20A**	Thermactor Air Pump (Low Emission Vehicles Only)
18	40A**	PCM
19	—	Not Used
20	30A**	Wiper Motor
21	30A**	Starter Solenoid
22	30A**	ABS Motor
23	—	Not Used (Fuse Plug)
24	—	Not Used
Relay 01	—	Wiper Hi/Lo
Relay 02	—	Wiper Park
Relay 03	—	COP's and HEGO's
Relay 04	—	Not Used
Relay 05	—	Auxiliary Coolant Pump (V8)
Relay 06	—	Horn
Relay 07	—	Fog Lamps
Relay 08	—	A/C Clutch
Relay 09	—	Wiper Run/Acc
Relay 10	—	Blower Motor
Relay 11	—	Not Used
Relay 12	—	Heated Wiper Park
Relay 13	—	Not Used
Relay 14	—	PCM Power
Relay 15	—	Starter Motor
Diode	—	PCM
*Mini fuses **Cartridge fuses		

# Roadside emergencies

## Rear power distribution box

The rear power distribution box is located in the luggage compartment under the spare tire well cover. The power distribution box contains high-current fuses that protect your vehicle's main electrical systems from overloads.

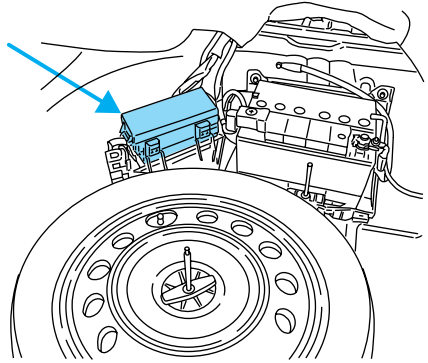

Always disconnect the battery before servicing high current fuses.



Always replace the cover to the Power Distribution Box before reconnecting the battery or refilling fluid reservoirs.

If the battery has been disconnected and reconnected, refer to the *Battery* section of the *Maintenance and care* chapter.

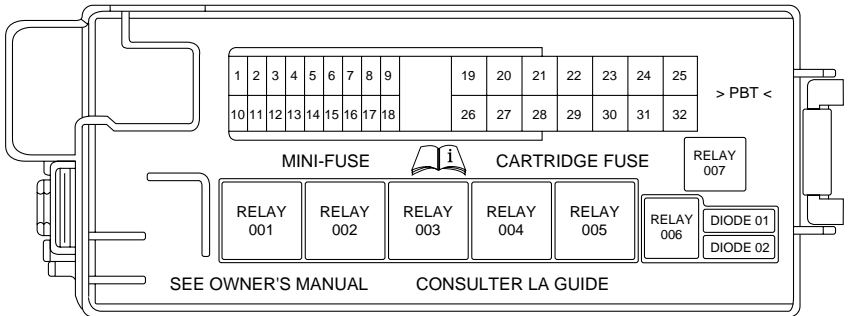

## Roadside emergencies

The high-current fuses are coded as follows.

<b>Fuse/Relay Location</b>	<b>Fuse Amp Rating</b>	<b>Power Distribution Box Description</b>
1	15A*	Decklid Release Solenoid
2	10A*	Right Rear Turn Lamp
3	5A*	Left Rear Stop Lamp
4	10A*	Fuel Door Release Solenoid
5	10A*	Courtesy and Map Lamps
6	10A*	Left Rear Turn and Back-up Lamps
7	5A*	Right Rear Stop Lamp
8	10A*	Center High Mounted Stop Lamp
9	5A*	Heated Mirror
10	20A*	Powerpoint
11	15A*	Heated Seats
12	5A*	Transit Relay (if equipped)
13	—	Not Used
14	5A*	Phone, CD, VEMS
15	5A*	Alternator Sense
16	20A*	Moonroof
17	15A*	Fuel Pump
18	20A*	Subwoofer Amplifier
19	20A**	REM - Left Rear Window
20	20A**	DDM - Driver Window
21	20A**	Driver Lumbar, Power Seats
22	20A**	Ignition Switch
23	30A**	SSP4
24	30A**	SSP3
25	40A**	P-J/B
26	20A**	FEM - Front Passenger Window
27	30A**	SSP1
28	20A**	Passenger Lumbar, Power Seats
29	30A**	Rear Defroster

## Roadside emergencies

Fuse/Relay Location	Fuse Amp Rating	Power Distribution Box Description
30	20A**	REM - Right Rear Window
31	20A**	Ignition Switch (V6 manual trans)
32	30A**	SSP2
Relay 001	—	SSP1
Relay 002	—	SSP4
Relay 003	—	Rear Defroster
Relay 004	—	SSP3
Relay 005	—	SSP2
Relay 006	—	Not Used
Relay 007	—	Fuel Pump
Diode 01	—	Not Used
Diode 02	—	Fuel Pump Motor
*Mini fuses **Maxi fuses		

### CHANGING THE TIRES

If you get a flat tire while driving, do not apply the brake heavily. Instead, gradually decrease your speed. Hold the steering wheel firmly and slowly move to a safe place on the side of the road.

#### Temporary spare tire information

Your vehicle may have a temporary or full-size spare tire. The temporary spare tire for your vehicle is labeled as such. It is smaller than a regular tire and is designed for emergency use only. Replace this tire with a full-size tire as soon as possible.



If you use the temporary spare tire continuously or do not follow these precautions, the tire could fail, causing you to lose control of the vehicle, possibly injuring yourself or others.

When driving with the temporary spare tire **do not:**

- exceed 80 km/h (50 mph) under any circumstances
- load the vehicle beyond maximum vehicle load rating listed on the Safety Compliance Label
- tow a trailer

## Roadside emergencies

- use tire chains
- drive through an automatic car wash, because of the vehicle's reduced ground clearance
- try to repair the temporary spare tire or remove it from its wheel
- drive for long distances when the temporary-use spare is on
- operate the vehicle with more than one temporary-use spare tire
- improperly inflate the temporary-use spare
- use the wheel for any other type of vehicle

### Tire change procedure



To prevent the vehicle from moving when you change a tire, be sure the parking brake is set, then block (in both directions) the wheel that is diagonally opposite (other side and end of the vehicle) to the tire being changed.



If the vehicle slips off the jack, you or someone else could be seriously injured.

1. Park on a level surface, activate hazard flashers and set parking brake.

2. Place gearshift lever in P (Park) or R (manual transmission), turn engine OFF, and block the diagonally opposite wheel.

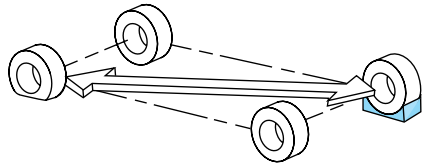

## Roadside emergencies

3. Lift the trunk cargo cover and remove the spare tire, jack and lug wrench.

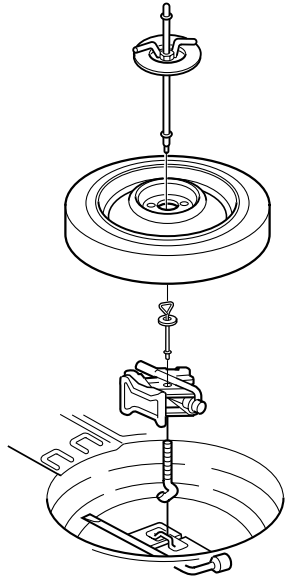

4. Loosen each wheel lug nut one-half turn counterclockwise but do not remove them until the wheel is raised off the ground.

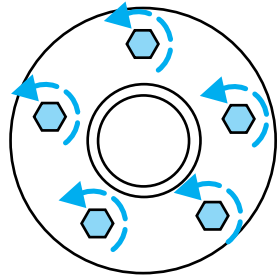

5. Put the jack in the jack notch next to the tire you are changing. Turn the jack handle clockwise until the wheel is completely off the ground.

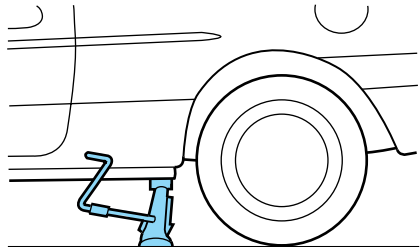

## Roadside emergencies

### Never use the rear differential as a jacking point.



To lessen the risk of personal injury, do not put any part of your body under the vehicle while changing a tire. Do not start the engine when your vehicle is on the jack. The jack is only meant for changing the tire.

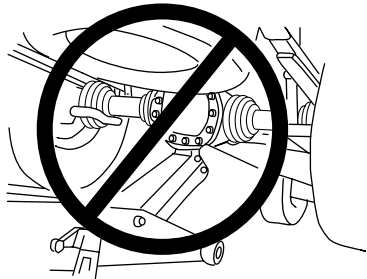

6. Remove the lug nuts with the lug wrench.
  7. Replace the flat tire with the spare tire, making sure the valve stem is facing outward. Reinstall lug nuts until the wheel is snug against the hub. Do not fully tighten the lug nuts until the wheel has been lowered.
- If you are using the temporary tire, the lug nut washers will not appear to be flush with the rim. This is normal only when using the temporary spare tire.
8. Lower the wheel by turning the jack handle counterclockwise.
  9. Remove the jack and fully tighten the lug nuts in the order shown.
  10. Put flat tire, jack and lug wrench away. Make sure jack is fastened so it does not rattle when you drive.
  11. Unblock the wheels.

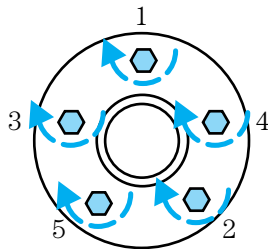

### Anti-theft lug nuts (if equipped)

If your vehicle is equipped with this feature, one of the lug nuts on each wheel must be removed and replaced with a special key. The key and registration card are attached to the lug wrench and stored with the spare tire. If you lose the key, send the registration card to the manufacturer (not the dealer) to get a replacement key. If the lug wrench/lug nut key assembly is lost, see your nearest Ford or Lincoln/Mercury dealer who has access to the master set of keys. **Do not use an impact wrench with the anti-theft key.**



## Roadside emergencies

To remove the anti-theft lug nut:

1. Insert the key over the locking lug nut. Make sure you hold the key square to the lug nut. If you hold the key at an angle, you could damage the key and the lug nut.

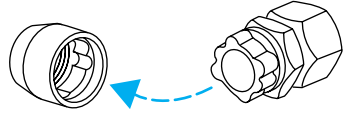

2. Place the lug nut wrench over the lug nut key and apply pressure on the key with the wrench.

3. Turn the wrench in a counterclockwise direction to remove the lug nut.

To install the anti-theft lug nut:

1. Insert the key over the locking lug nut.

2. Place the lug nut wrench over the lug nut key and apply pressure on the key with the wrench.

3. Install the lug nut.

## JUMP STARTING YOUR VEHICLE



The gases around the battery can explode if exposed to flames, sparks, or lit cigarettes. An explosion could result in injury or vehicle damage.



Do not push start your vehicle. You could damage the catalytic converter.



Batteries contain sulfuric acid which can burn skin, eyes, and clothing, if contacted.

**Do not attempt to push start your vehicle. Automatic transmissions do not have push-start capability.**

## Preparing your vehicle

Your battery is located in the trunk of your vehicle.

When the battery is disconnected or a new battery is installed, the transmission must relearn its adaptive strategy. As a result of this, the transmission may shift firmly. This operation is considered normal and will not effect function or durability of the transmission. Over time, the

## Roadside emergencies

adaptive learning process will fully update transmission operation to its optimum shift feel.

1. **Use only a 12-volt supply to start your vehicle.**
2. Do not disconnect the battery of your disabled vehicle as this could damage the vehicle's electrical system. Keep the battery vent hose attached at all times.
3. Park the booster vehicle close to the trunk of your disabled vehicle making sure the two vehicles **do not** touch. Set the parking brake on both vehicles and stay clear of the engine cooling fan and other moving parts.
4. Check all battery terminals and remove any excessive corrosion before you attach the battery cables.
5. Turn the heater fan on in both vehicles to protect any electrical surges. Turn all other accessories off.

### Connecting the jumper cables

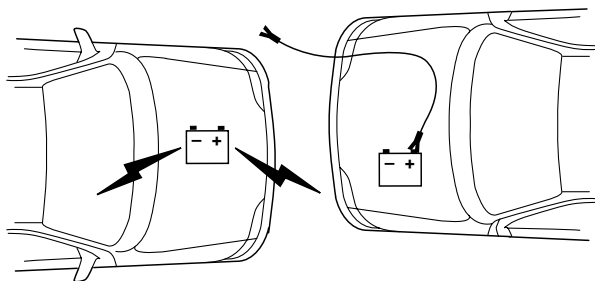

1. Connect the positive (+) booster cable to the positive (+) terminal of the discharged battery.

**Note:** In the illustrations, *lightning bolts* are used to designate the assisting (boosting) battery.

## Roadside emergencies

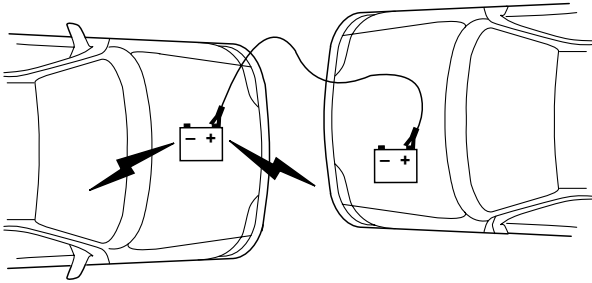

2. Connect the other end of the positive (+) cable to the positive (+) terminal of the assisting battery.

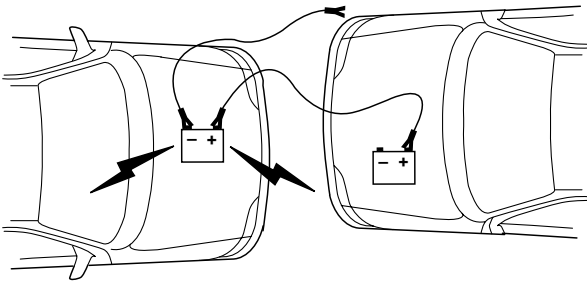

3. Connect the negative (-) cable to the negative (-) terminal of the assisting battery.

## Roadside emergencies

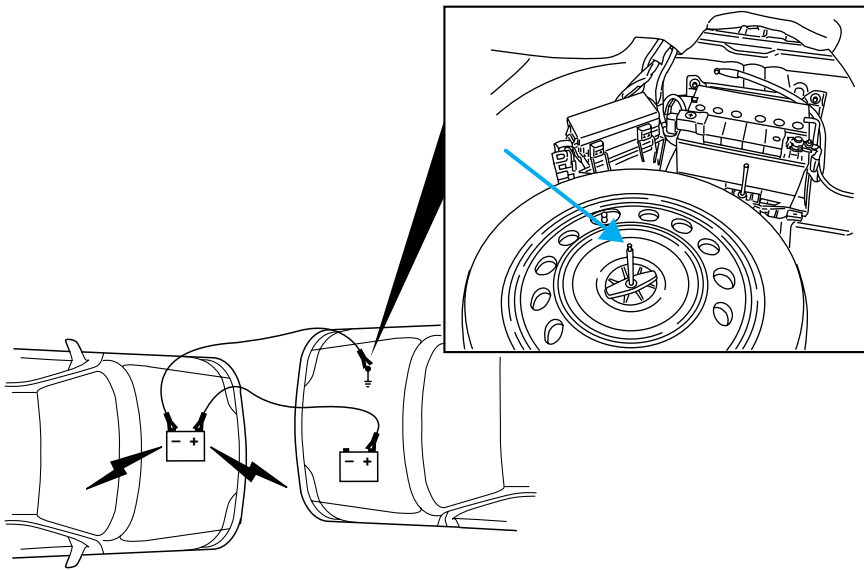

4. Make the final connection of the negative (-) cable to the spare tire tie-down stud. (Your vehicle may be equipped with a plastic cap on top of the tire tie-down stud. This cap must be removed prior to attaching the cable to the stud.)



Do not connect the end of the second cable to the negative (-) terminal of the battery to be jumped. A spark may cause an explosion of the gases that surround the battery.

5. Ensure that the cables are clear of fan blades, belts, moving parts of both engines, or any fuel delivery system parts.

### **Jump starting**

1. Start the engine of the booster vehicle and run the engine at moderately increased speed.
2. Start the engine of the disabled vehicle.
3. Once the disabled vehicle has been started, run both engines for an additional three minutes before disconnecting the jumper cables.

## Roadside emergencies

### Removing the jumper cables

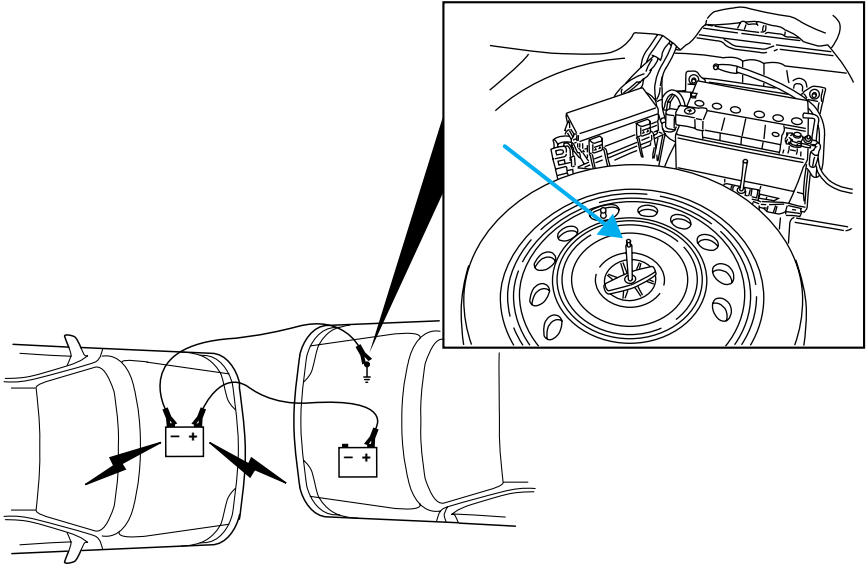

**Remove the jumper cables in the reverse order that they were connected.**

1. Remove the jumper cable from the spare tire tie-down stud.

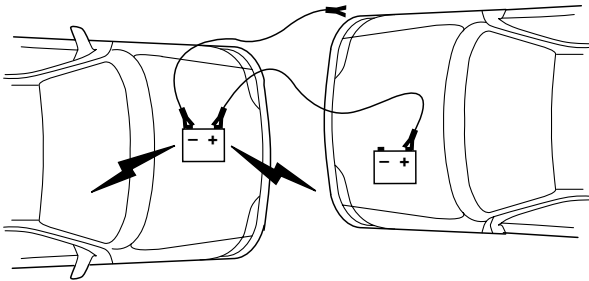

2. Remove the jumper cable on the negative (-) connection of the booster vehicle's battery.

## Roadside emergencies

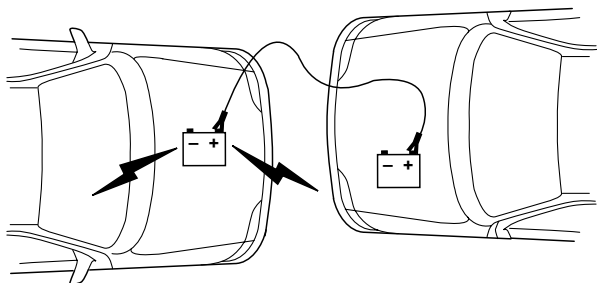

3. Remove the jumper cable from the positive (+) terminal of the booster vehicle's battery.

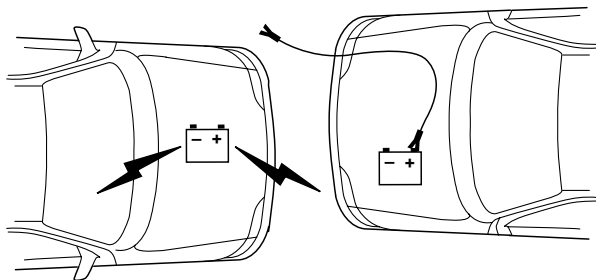

4. Remove the jumper cable from the positive (+) terminal of the disabled vehicle's battery.

After the disabled vehicle has been started and the jumper cables removed, allow it to idle for several minutes so the engine computer can *relearn* its idle conditions.

When the battery is disconnected or a new battery is installed, the transmission must relearn its adaptive strategy. As a result of this, the transmission may shift firmly. This operation is considered normal and will not effect function or durability of the transmission. Over time, the adaptive learning process will fully update transmission operation to its optimum shift feel.

## Roadside emergencies

### WRECKER TOWING

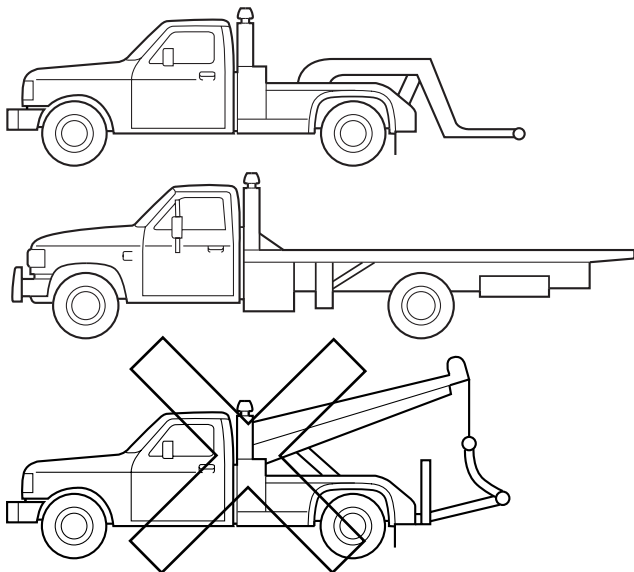

If you need to have your vehicle towed, contact a professional towing service or, if you are a member, your roadside assistance center.

It is recommended that your vehicle be towed with a wheel lift or flatbed equipment. Do not tow with a slingbelt. Ford Motor Company has not approved a slingbelt towing procedure.

**If the vehicle is towed by other means or incorrectly, vehicle damage may occur.**

Ford Motor Company provides a towing manual for all authorized tow truck operators. Have your tow truck operator refer to this manual for proper hook-up and towing procedures for your vehicle.

# Maintenance and care

## SERVICE RECOMMENDATIONS

To help you service your vehicle:

- We highlight do-it-yourself items in the engine compartment for easy location.
- We provide a scheduled maintenance guide which makes tracking routine service easy.

If your vehicle requires professional service, your dealership can provide the necessary parts and service. Check your “Warranty Guide” to find out which parts and services are covered.

Use only recommended fuels, lubricants, fluids and service parts conforming to specifications. Motorcraft parts are designed and built to provide the best performance in your vehicle.

## PRECAUTIONS WHEN SERVICING YOUR VEHICLE

Be especially careful when inspecting or servicing your vehicle.

- Do not work on a hot engine.
- When the engine is running, keep loose clothing, jewelry or long hair away from moving parts.
- Do not work on a vehicle with the engine running in an enclosed space, unless you are sure you have enough ventilation.
- Keep all lit cigarettes, open flames and other lit material away from the battery and all fuel related parts.

If you disconnect the battery, the engine must “relearn” its idle conditions before your vehicle will drive properly, as explained in the *Battery* section in this chapter.

## Working with the engine off

- Automatic transmission:
  1. Set the parking brake and ensure the gearshift is securely latched in P (Park).
  2. Turn off the engine and remove the key.
  3. Block the wheels to prevent the vehicle from moving unexpectedly.
- Manual transmission:
  1. Set the parking brake.
  2. Depress the clutch and place the gearshift in 1 (First).



## Maintenance and care

3. Turn off the engine and remove the key.
4. Block the wheels to prevent the vehicle from moving unexpectedly.

### Working with the engine on

- Automatic transmission:
  1. Set the parking brake and ensure the gearshift is securely latched in P (Park).
  2. Block the wheels to prevent the vehicle from moving unexpectedly.



Do not start your engine with the air cleaner removed and do not remove it while the engine is running.

- Manual transmission:
  1. Set the parking brake, depress the clutch and place the gearshift in neutral.
  2. Block the wheels to prevent the vehicle from moving unexpectedly.



Do not start your engine with the air cleaner removed and do not remove it while the engine is running.



The cooling fan is automatic and may come on at any time. Always disconnect the negative terminal of the battery before working near the fan.

### OPENING THE HOOD

1. Inside the vehicle, pull the hood release handle located at the bottom left of the instrument panel.
2. Go to the front of the vehicle and release the auxiliary latch that is located under the front center of the hood by pushing upward on the handle.
3. Lift the hood until the lift cylinders hold it open.

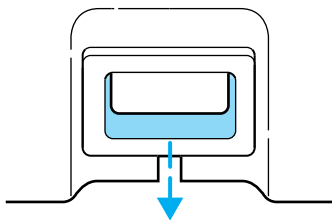

## Maintenance and care

### IDENTIFYING COMPONENTS IN THE ENGINE COMPARTMENT

#### 3.0L DOHC V6 engine

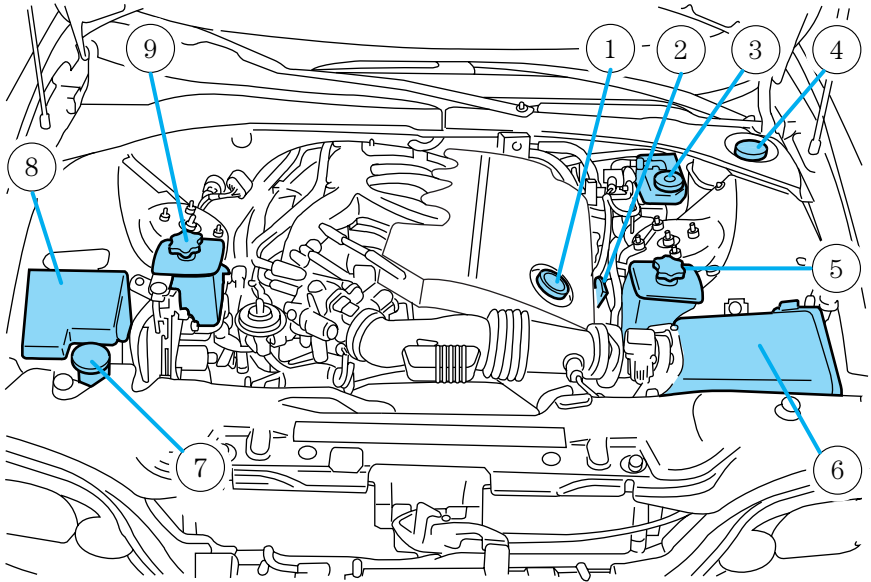

1. Engine oil filler cap
2. Engine oil dipstick
3. Brake (and clutch, if equipped) fluid reservoir
4. Engine coolant reservoir
5. Power steering fluid reservoir
6. Air filter assembly
7. Windshield washer fluid reservoir
8. Power distribution box
9. Engine cooling fan fluid reservoir

## Maintenance and care

### 3.9L-4V V8 engine

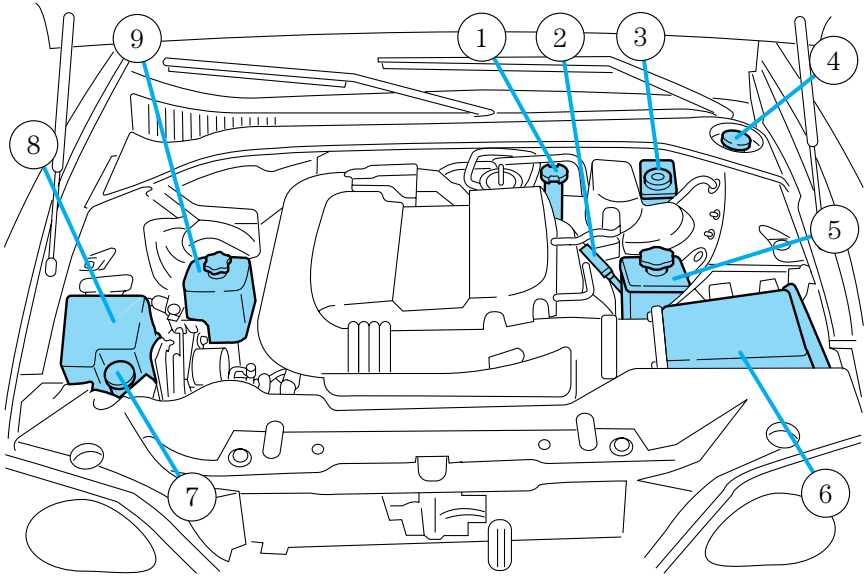

1. Engine oil filler cap
2. Engine oil dipstick
3. Brake fluid reservoir
4. Engine coolant reservoir
5. Power steering fluid reservoir
6. Air filter assembly
7. Windshield washer fluid reservoir
8. Power distribution box
9. Engine cooling fan fluid reservoir

### ENGINE OIL

#### Checking the engine oil

Refer to the scheduled maintenance guide for the appropriate intervals for checking the engine oil.

1. Make sure the vehicle is on level ground.

## Maintenance and care

2. Turn the engine off and wait a few minutes for the oil to drain into the oil pan.
3. Set the parking brake and ensure the gearshift is securely latched in P (Park) (automatic transmission) or 1 (First) (manual transmission).
4. Open the hood. Protect yourself from engine heat.
5. Locate and carefully remove the engine oil level indicator (dipstick).

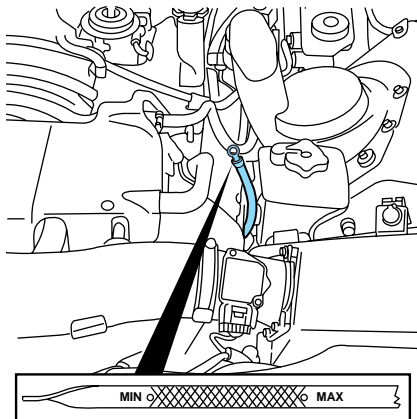

6. Wipe the indicator clean. Insert the indicator fully, then remove it again.

- If the oil level is **between the MIN and MAX marks**, the oil level is acceptable. **DO NOT ADD OIL.**
- If the oil level is below the MIN mark, add enough oil to raise the level within the MIN-MAX range.

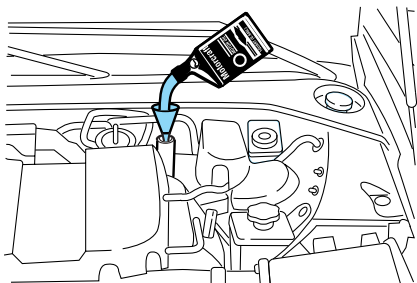

- Oil levels above the MAX mark may cause engine damage. Some oil must be removed from the engine by a service technician.

7. Put the indicator back in and ensure it is fully seated.

### Adding engine oil

1. Check the engine oil. For instructions, refer to *Checking the engine oil* in this chapter.
2. If the engine oil level is not within the normal range, add only certified engine oil of the recommended viscosity. Remove the engine oil filler cap and use a funnel to pour the engine oil into the opening.
3. Recheck the engine oil level. Make sure the oil level is not above the MAX mark on the engine oil level indicator (dipstick).
4. Install the indicator and ensure it is fully seated.
5. Fully install the engine oil filler cap by turning the filler cap clockwise tightly until snug.

**To avoid possible oil loss, DO NOT operate the vehicle with the engine oil level indicator and/or the engine oil filler cap removed.**

### Engine oil and filter recommendations

#### 3.0L Engine

Look for this certification trademark.

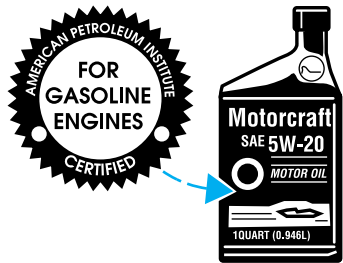

**SAE 5W-20 engine oil is recommended.**

Only use oils “Certified For Gasoline Engines” by the American Petroleum Institute (API). Use the Motorcraft (Part: XO-5W20-QSP in U.S.) or an equivalent oil meeting Ford Specification WSS-M2C153-H. **SAE 5W-20 oil provides optimum fuel economy and durability performance meeting all requirements for your vehicle’s engine.**

Change your engine oil and filter according to the appropriate schedule listed in the scheduled maintenance guide.

Do not use supplemental engine oil additives, oil treatments or engine treatments. They are unnecessary and could, under certain conditions, lead to engine damage which is not covered by your warranty.

## Maintenance and care

Ford production and aftermarket (Motorcraft) oil filters are designed for added engine protection and long life. If a replacement oil filter is used that does not meet Ford material and design specifications, start-up engine noises or knock may be experienced.

It is recommended you use the appropriate Motorcraft oil filter (or another brand meeting Ford specifications) for your engine application.

### 3.9L Engine

Look for this certification trademark.

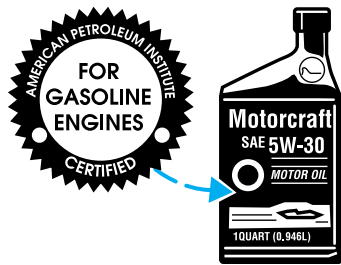

### ***SAE 5W-30 engine oil is recommended.***

Only use oils “Certified For Gasoline Engines” by the American Petroleum Institute (API). Use Motorcraft or an equivalent oil meeting Ford Specification WSS-M2C153-G.

Do not use supplemental engine oil additives, oil treatments or engine treatments. They are unnecessary and could, under certain conditions, lead to engine damage which is not covered by your warranty.

Change your engine oil according to the appropriate schedule listed in the scheduled maintenance guide.

### **Engine Oil Filter Recommendation**

Change your engine oil filter according to the appropriate schedule listed in the scheduled maintenance guide. Ford production and aftermarket (Motorcraft) oil filters are designed for added engine protection and long life. If a replacement oil filter is used that does not meet Ford Material and design specifications, start-up engine noises or knock may be experienced.

It is recommended you use the appropriate Motorcraft oil filter (or another brand meeting Ford specifications) for your engine.

### BRAKE FLUID (⚠)

#### Checking and adding brake fluid

Brake fluid should be checked and refilled as needed. Refer to the scheduled maintenance guide for the service interval schedules.

1. Clean the reservoir cap before removal to prevent dirt or water from entering the reservoir.

2. Visually inspect the fluid level.

3. If necessary, add brake fluid from a clean un-opened container until the level reaches MAX. Do not fill above this line.

4. Use only brake fluids certified to meet Ford specifications. Refer to *Lubricant specification* in the *Capacities and specifications* chapter. DOT 3 fluid is recommended. However, if DOT 3 is not available, DOT 4 fluid can be used.

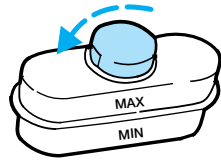
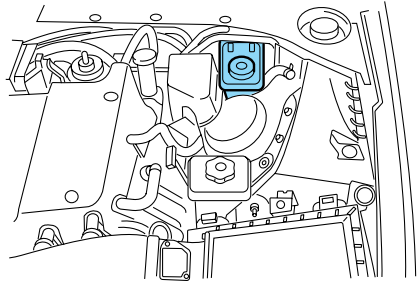

Brake fluid is toxic. If brake fluid contacts the eyes, flush eyes with running water for 15 minutes. Seek medical attention if irritation persists. If taken internally, drink water and induce vomiting. Seek medical attention immediately.



If you use DOT 5 or any other brake fluid that is not DOT 3 or DOT 4, you will cause permanent damage to your brakes.



Do not let the fluid level in the reservoir for the master cylinder fall below the MIN mark. If master cylinder runs dry, this may cause the brakes to fail.

## Maintenance and care

### CLUTCH FLUID (IF EQUIPPED)

The clutch master cylinder and brake master cylinder are part of the same system; both are refillable through the brake master cylinder with brake fluid. For more information on brake fluid maintenance, refer to *Brake fluid* in this chapter.

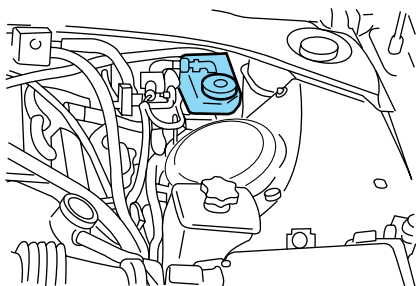

Brake fluid is toxic. If brake fluid contacts the eyes, flush eyes with running water for 15 minutes. Seek medical if irritation persists. If taken internally, drink water and induce vomiting. Seek medical attention immediately.

### WASHER FLUID

Check the washer fluid whenever you stop for fuel. The reservoir is highlighted with a  symbol.

If the level is low, add enough fluid to fill the reservoir. In very cold weather, do not fill the reservoir all the way.



Only use a washer fluid that meets Ford specification. Refer to *Lubricant specifications* in the *Capacities and specifications* chapter.

State or local regulations on volatile organic compounds may restrict the use of methanol, a common windshield washer antifreeze additive.

Washer fluids containing non-methanol antifreeze agents should be used



only if they provide cold weather protection without damaging the vehicle's paint finish, wiper blades or washer system.

**Do not put washer fluid in the engine coolant reservoir. Washer fluid placed in the cooling system may harm engine and cooling system components.**

### ENGINE COOLANT

#### Checking engine coolant

The concentration and level of engine coolant should be checked at the mileage intervals listed in the scheduled maintenance guide. The coolant concentration should be maintained at 50/50 coolant and water, which equates to a freeze point of  $-36^{\circ}\text{C}$  ( $-34^{\circ}\text{F}$ ). Coolant concentration testing is possible with a hydrometer or antifreeze tester (such as the Rotunda Battery and Antifreeze Tester, 014-R1060). The level of coolant should be maintained at the “cold full” or “cold fill range” level in the coolant reservoir. If the level falls below, add coolant per the instructions in the *Adding Engine Coolant* section.

Your vehicle was factory-filled with a 50/50 engine coolant and water concentration. If the concentration of coolant falls below 40% or above 60%, the engine parts could become damaged or not work properly. **A 50-50 mixture of coolant and water provides the following:**

- **freeze protection down to  $-36^{\circ}\text{C}$  ( $-34^{\circ}\text{F}$ ).**
- **boiling protection up to  $129^{\circ}\text{C}$  ( $265^{\circ}\text{F}$ ).**
- **protection against rust and other forms of corrosion.**
- **enables calibrated gages to function properly.**

## Maintenance and care

When the engine is cold, check the level of the engine coolant in the reservoir.

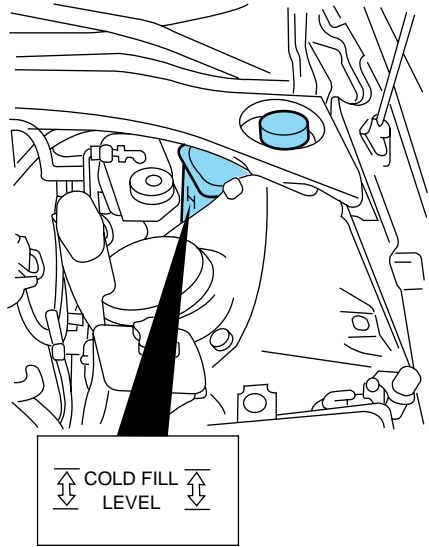

- The engine coolant should be at the “cold fill level” as listed on the engine coolant reservoir.
- Refer to the scheduled maintenance guide for service interval schedules.
- Be sure to read and understand *Precautions when servicing your vehicle* in this chapter.

If the engine coolant has not been checked at the recommended interval, the engine coolant reservoir may become low or empty:

- If the reservoir is low, add engine coolant to the reservoir. Refer to *Adding engine coolant* in this chapter.
- If the engine coolant reservoir has become completely empty, have the engine cooling system inspected and refilled by a qualified service technician.



Automotive fluids are not interchangeable; do not use engine coolant, antifreeze or windshield washer fluid outside of its specified function and vehicle location.

### Adding engine coolant

Use only **Ford Premium Engine Coolant (green in color)** or a **premium engine coolant that meets Ford specification ESE-M97B44-A**.

- **DO NOT USE Ford Extended Life Engine Coolant F6AZ-19544-AA (orange in color).**
- **DO NOT USE a DEX-COOL® engine coolant or an equivalent engine coolant that meets Ford specification WSS-M97B44-D.**
- **DO NOT USE alcohol or methanol antifreeze or any engine coolants mixed with alcohol or methanol antifreeze.**
- **DO NOT USE supplemental coolant additives in your vehicle. These additives may harm your engine's cooling system.**
- **DO NOT MIX recycled coolant and conventional coolant together in your vehicle. Mixing of engine coolants may harm your engine's cooling system.**
- **The use of an improper coolant may harm engine and cooling system components and may void the warranty of your vehicle's engine cooling system. If you are unsure which type of coolant your vehicle requires, contact your local dealer.**



To avoid scalding hot steam or coolant from being released from the engine cooling system, never remove the pressure relief cap from the engine coolant reservoir while the engine is running or hot. Failure to follow this warning may result in damage to the engine's cooling system and possible severe personal injury.



Do not put engine coolant in the windshield washer fluid reservoir. If engine coolant is sprayed onto the windshield, it could make it difficult to see through the windshield.

When the engine is cool, add a **50/50 mixture** of engine coolant and distilled water to the engine coolant reservoir, until the coolant is at the “cold fill level” or within the “cold fill range” as listed in the engine coolant reservoir (depending upon application).

- **NEVER increase the coolant concentration above 60%.**
- **NEVER decrease the coolant concentration below 40%.**

## Maintenance and care

- **Engine coolant concentrations above 60% or below 40% will decrease the freeze protection characteristics of the engine coolant and may cause engine damage.**

Plain water may be added in an emergency, but you **must** replace it with a 50/50 mixture of engine coolant and distilled water as soon as possible.

Check the coolant level in the reservoir before you drive your vehicle the next few times (with the engine cool). If necessary, add a **50/50 mixture** of engine coolant and distilled water to the engine coolant reservoir until the coolant level is at the “cold fill level” or within the “cold fill range” as listed on the reservoir (depending upon application).

Have your dealer check the engine cooling system for leaks if you have to add more than 1.0 liter (1.0 quart) of engine coolant per month.



To avoid scalding hot steam or coolant from being released from the engine cooling system, never remove the pressure relief cap from the engine coolant reservoir while the engine is running or hot. Failure to follow this warning may result in damage to the engine's cooling system and possible severe personal injury.

If you must remove the pressure relief cap from the engine coolant reservoir, follow these steps to avoid personal injury:

1. Before you remove the cap, turn the engine off and let it cool.
2. When the engine is cool, wrap a thick cloth around the cap. Slowly turn cap counterclockwise until pressure begins to release.
3. Step back while the pressure releases.
4. When you are sure that all the pressure has been released, use the cloth to turn it counterclockwise and remove the cap.

### Recycled engine coolant

Ford Motor Company recommends the use of a recycled engine coolant produced by Ford-approved processes.

Not all coolant recycling processes produce coolant which meets Ford specification WSS-M97B51-A1. Use of a recycled engine coolant which does not meet the Ford G05 specification may harm engine and cooling system components.



Always dispose of used automotive fluids in a responsible manner. Follow your community's regulations and standards for recycling and disposing of automotive fluids.

### Coolant refill capacity

To find out how much fluid your vehicle's cooling system can hold, refer to *Refill capacities* in the *Capacities and specifications* chapter.

Fill your engine coolant reservoir as outlined in *Adding engine coolant* in this chapter.

### Severe climates

If you drive in extremely cold climates (less than  $-36^{\circ}\text{C}$  [ $-34^{\circ}\text{F}$ ]):

- **it may be necessary to increase the coolant concentration above 50%.**
- **NEVER increase the coolant concentration above 60%.**
- **increased engine coolant concentrations above 60% will decrease the overheat protection characteristics of the engine coolant and may cause engine damage.**
- **refer to the chart on the coolant container to ensure the coolant concentration in your vehicle will provide adequate freeze protection at the temperatures in which you drive in the winter months.**

If you drive in extremely hot climates:

- **it is still necessary to maintain the coolant concentration above 40%.**
- **NEVER decrease the coolant concentration below 40%.**
- **decreased engine coolant concentrations below 40% will decrease the corrosion protection characteristics of the engine coolant and may cause engine damage.**
- **decreased engine coolant concentrations below 40% will decrease the freeze protection characteristics of the engine coolant and may cause engine damage.**
- **refer to the chart on the coolant container to ensure the coolant concentration in your vehicle will provide adequate protection at the temperatures in which you drive.**

## Maintenance and care



Vehicles driven year-round in non-extreme climates should use a 50/50 mixture of engine coolant and distilled water for optimum cooling system and engine protection.

### What you should know about fail-safe cooling

If the engine coolant supply is depleted, this feature allows the vehicle to be driven temporarily before incremental component damage is incurred. The “fail-safe” distance depends on ambient temperatures, vehicle load and terrain.

#### How fail-safe cooling works

If the engine begins to overheat:

- the engine coolant temperature gauge will move to the H (hot) area.
- the  symbol will illuminate.
- the  symbol will illuminate.
- the  symbol will illuminate.

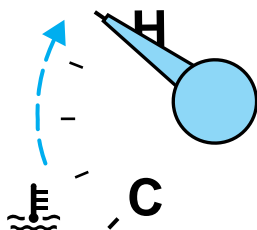

If the engine reaches a preset over-temperature condition, the engine will automatically switch to alternating cylinder operation. Each disabled cylinder acts as an air pump and cools the engine.

When this occurs the vehicle will still operate. However:

- the engine power will be limited.
- the air conditioning system will be disabled.

Continued operation will increase the engine temperature and the engine will completely shut down, causing steering and braking effort to increase

Once the engine temperature cools, the engine can be re-started. Take your vehicle to a service facility as soon as possible to minimize engine damage.

#### When fail-safe mode is activated

You have limited engine power when in the fail-safe mode, so drive the vehicle with caution. The vehicle will not be able to maintain high-speed operation and the engine will run rough. Remember that the engine is capable of completely shutting down automatically to prevent engine damage, therefore:

## Maintenance and care

1. Pull off the road as soon as safely possible and turn off the engine.
2. Arrange for the vehicle to be taken to a service facility.
3. If this is not possible, wait a short period for the engine to cool.
4. Check the coolant level and replenish if low.



Never remove the coolant reservoir cap while the engine is running or hot.

5. Re-start the engine and take your vehicle to a service facility.



Driving the vehicle without repairing the engine problem increases the chance of engine damage. Take your vehicle to a service facility as soon as possible.

### Checking and adding engine cooling fan hydraulic fluid

Check the engine cooling fan hydraulic fluid. Refer to the scheduled maintenance guide for the service interval schedules. If adding fluid is necessary, use only MERCON® ATF.

Check the fluid level when it is at ambient temperature ( $-7^{\circ}$  to  $25^{\circ}$  C [ $20^{\circ}$  to  $80^{\circ}$  F]):

1. Check the fluid level in the reservoir. It should be between the MIN and MAX lines. Do not add fluid if the level is in this range.
2. If the fluid is low, add fluid in small amounts, continuously checking the level until it reaches the range between the MIN and MAX lines. Be sure to put the cap back on the reservoir.

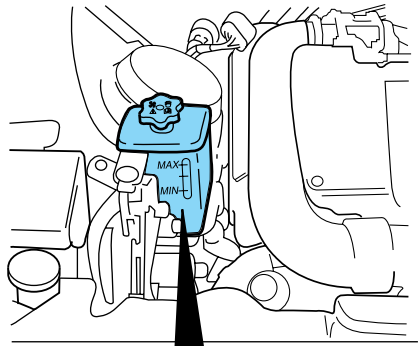

## Maintenance and care

### POWER STEERING FLUID

Refer to the scheduled maintenance guide for the service interval schedules. If adding fluid is necessary, use only MERCON® ATF.

1. Start the engine and let it run until it reaches normal operating temperature (the engine coolant temperature gauge indicator will be near the center of the normal area between H and C).
2. While the engine idles, turn the steering wheel left and right several times.
3. Turn the engine off.
4. Check the fluid level in the reservoir. It should be between the MIN and MAX lines. Do not add fluid if the level is in this range.
5. If the fluid is low, add fluid in small amounts, continuously checking the level until it reaches the range between the MIN and MAX lines. Be sure to put the cap back on the reservoir.

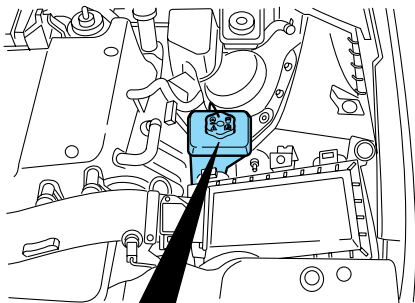

### TRANSMISSION FLUID

#### Checking automatic transmission fluid

The 5R55N transmission does not have a transmission fluid dipstick.

Refer to your scheduled maintenance guide for scheduled intervals for fluid checks and changes. Your transmission does not consume fluid. However, the fluid level should be checked if the transmission is not working properly, i.e., if the transmission slips or shifts slowly or if you notice some sign of fluid leakage.

**Transmission fluid should be checked and, if required, fluid should be added by a qualified technician.**

Before adding any fluid, make sure the correct type is used. Use only MERCON® V automatic transmission fluid. The type of fluid used is indicated on the transmission fluid pan, extension housing and also in



## Maintenance and care

the *Lubricant specifications* section in the *Capacities and specifications* chapter.

**Use of a non-approved automatic transmission fluid may cause internal transmission component damage and void the warranty.**

### Checking and adding manual transmission fluid (if equipped)

1. Clean the filler plug.
2. Remove the filler plug and inspect the fluid level.

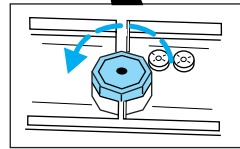
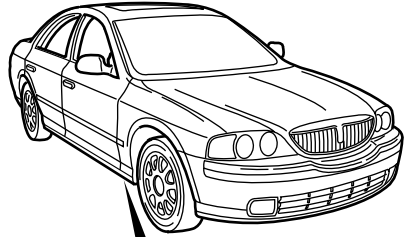

3. Fluid level should be at bottom of the opening.
4. Add enough fluid through the filler opening so that the fluid level is at the bottom of the opening.
5. Install and tighten the fill plug securely.

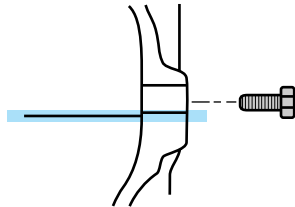

Use only fluid that meets Ford specifications. Refer to the *Capacities and specifications* chapter.

## Maintenance and care

### BATTERY

Your vehicle is equipped with a Motorcraft maintenance-free battery which is located in the luggage compartment, next to the spare tire.

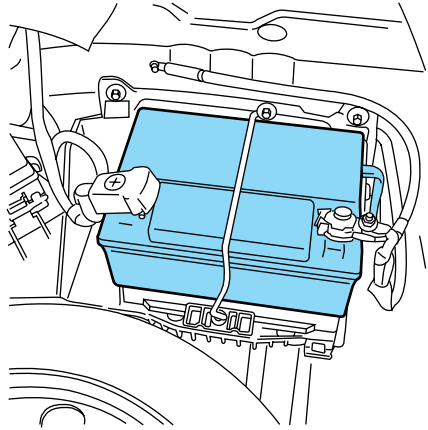

Your battery is designed to purge any battery gases to the outside of the vehicle by means of a vent hose. This vent hose **MUST** be attached at all times. Replacement batteries must be of the same vented design.

**If your battery has a cover/shield, make sure it is reinstalled after the battery has been cleaned or replaced.**

Your battery normally does not require additional water during its life of service. For longer, trouble-free operation, keep the top of the battery clean and dry. Make certain that the vent hose is attached. Also, make certain the battery cables are always tightly fastened to the battery terminals.

When the battery is disconnected or a new battery installed, the transmission must relearn its adaptive strategy. As a result of this, the transmission may shift firmly. This operation is considered normal and will not affect function or durability of the transmission. Over time the adaptive learning process will fully update transmission operation to its optimum shift feel.

If you see any corrosion on the battery or terminals, remove the cables from the terminals and clean with a wire brush. You can neutralize the acid with a solution of baking soda and water.

## Maintenance and care



Batteries normally produce explosive gases which can cause personal injury. Therefore, do not allow flames, sparks or lighted substances to come near the battery. When working near the battery, always shield your face and protect your eyes. Always provide proper ventilation.



When lifting a plastic-cased battery, excessive pressure on the end walls could cause acid to flow through the vent caps, resulting in personal injury and/or damage to the vehicle or battery. Lift the battery with a battery carrier or with your hands on opposite corners.



Keep batteries out of reach of children. Batteries contain sulfuric acid. Avoid contact with skin, eyes or clothing. Shield your eyes when working near the battery to protect against possible splashing of acid solution. In case of acid contact with skin or eyes, flush immediately with water for a minimum of 15 minutes and get prompt medical attention. If acid is swallowed, call a physician immediately.



Battery posts, terminals and related accessories contain lead and lead compounds. **Wash hands after handling.**

Because your vehicle's engine is electronically controlled by a computer, some control conditions are maintained by power from the battery. When the battery is disconnected or a new battery is installed, the engine must relearn its idle and fuel trim strategy for optimum driveability and performance. To begin this process:

1. With the vehicle at a complete stop, set the parking brake.
  2. Put the gearshift in P (Park), turn off all accessories and start the engine.
  3. Run the engine until it reaches normal operating temperature.
  4. Allow the engine to idle for at least one minute.
  5. Turn the A/C on and allow the engine to idle for at least one minute.
  6. Drive the vehicle to complete the relearning process.
- The vehicle may need to be driven to relearn the idle and fuel trim strategy.

## Maintenance and care

- **If you do not allow the engine to relearn its idle trim, the idle quality of your vehicle may be adversely affected until the idle trim is eventually relearned.**

When the battery is disconnected or a new battery installed, the transmission must relearn its adaptive strategy. As a result of this, the transmission may shift firmly. This operation is considered normal and will not affect function or durability of the transmission. Over time the adaptive learning process will fully update transmission operation to its optimum shift feel.

If the battery has been disconnected or a new battery has been installed, the clock and the preset radio stations must be reset once the battery is reconnected.

- Always dispose of automotive batteries in a responsible manner. Follow your local authorized standards for disposal. Call your local authorized recycling center to find out more about recycling automotive batteries.

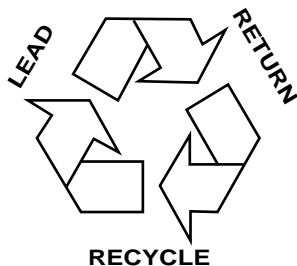

### AIR FILTER MAINTENANCE

Refer to the scheduled maintenance guide for the appropriate intervals for changing the air filter element.

When changing the air filter element, use only the Motorcraft air filter element listed. Refer to *Motorcraft Part Numbers* in the *Capacities and specifications* chapter.



Do not start your engine with the air cleaner removed and do not remove it while the engine is running.

## Maintenance and care

### Changing the air filter element

1. Loosen the hose clamp on the outlet tube at the air filter housing.
2. Release the two clamps that secure the cover to the air filter housing and place the cover aside.

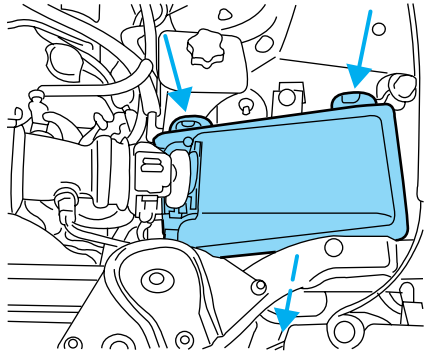
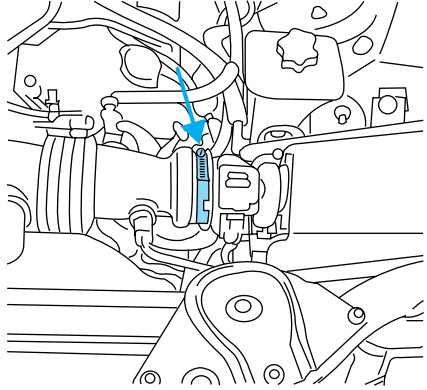

## Maintenance and care

3. Remove the air filter element from the air filter housing.

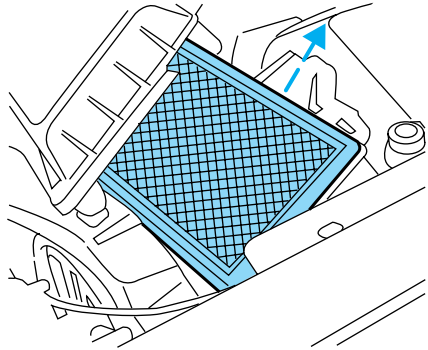

4. Wipe the air filter housing and cover clean to remove any dirt or debris and to ensure good sealing.

5. Install a new air filter element. Be careful not to crimp the filter element edges between the air filter housing and cover. This could cause filter damage and allow unmetered air to enter the engine if not properly seated.

6. Replace the air filter housing cover and secure the clamps.

## CABIN AIR FILTER

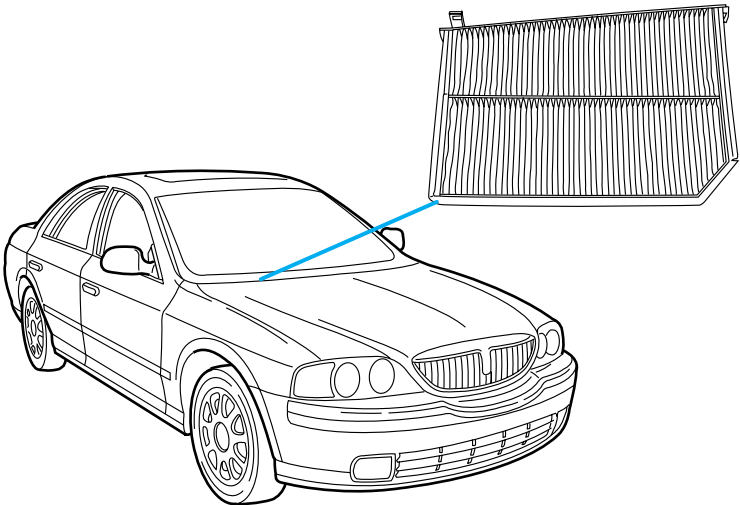

## Maintenance and care

The particulate air filtration system is designed to reduce the concentration of airborne particles such as dust, spores and pollen in the air being supplied to the interior of the vehicle. The particulate filtration system gives the following benefits to customers:

- Improves the customer's driving comfort by reducing particle concentration
- Improves the interior compartment cleanliness
- Protects the climate control components from particle deposits

The filter is located just in front of the windshield under the cowl grille on the passenger side of the vehicle.

To replace the filter, perform the following procedure:

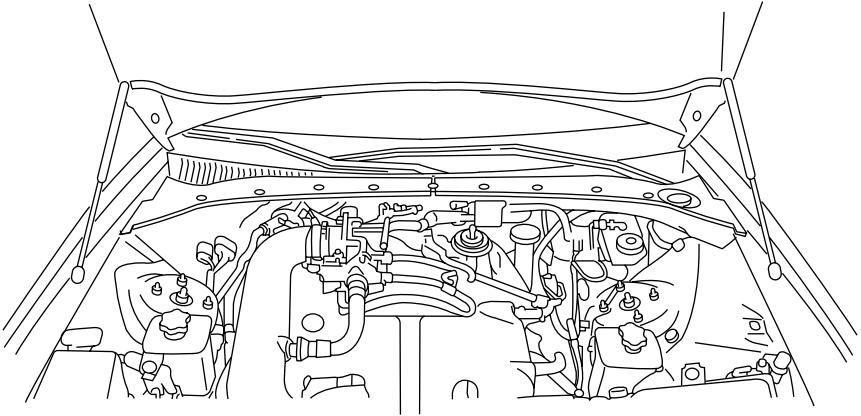

1. Open the hood.

## Maintenance and care

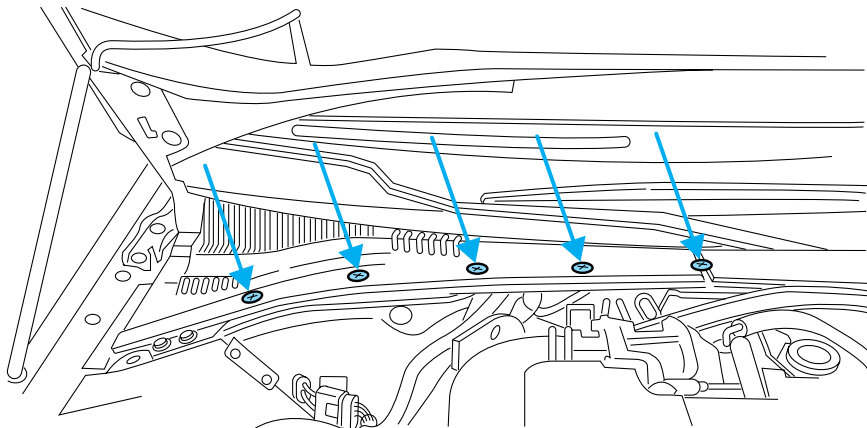

2. Remove the five pushpins that retain the passenger side portion of the cowl screen. To release the pins, depress the center “button” of the pins using a key or similar object. Note also that the cowl screen is retained to the rubber hood hinge cover with Velcro. This must be released to remove the cowl screen.

3. Remove the cowl cover.

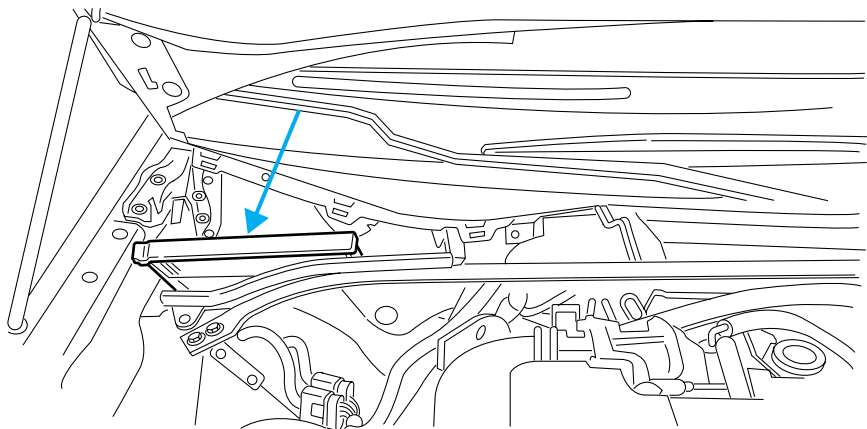

4. Release the clips in order to remove the cabin air filter from the cabin air filter housing. (Please note that releasing the clips might require a slight downward force).



## Maintenance and care

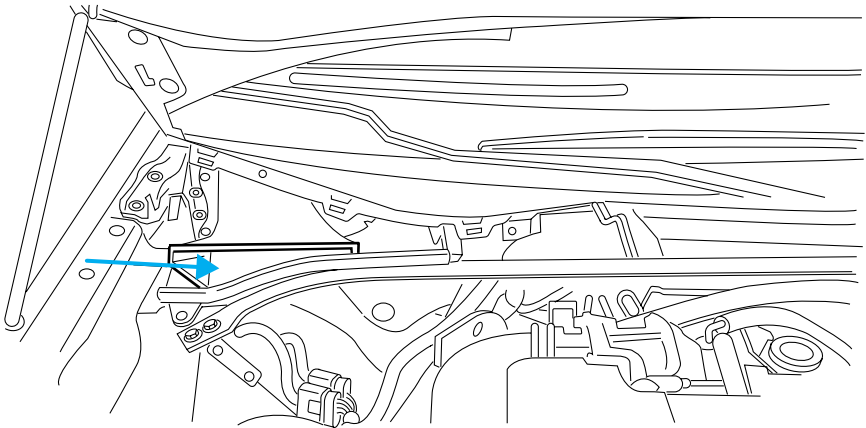

5. Insert the new cabin air filter into the cabin air filter housing until the clips are secure.

6. Install the cowl cover.

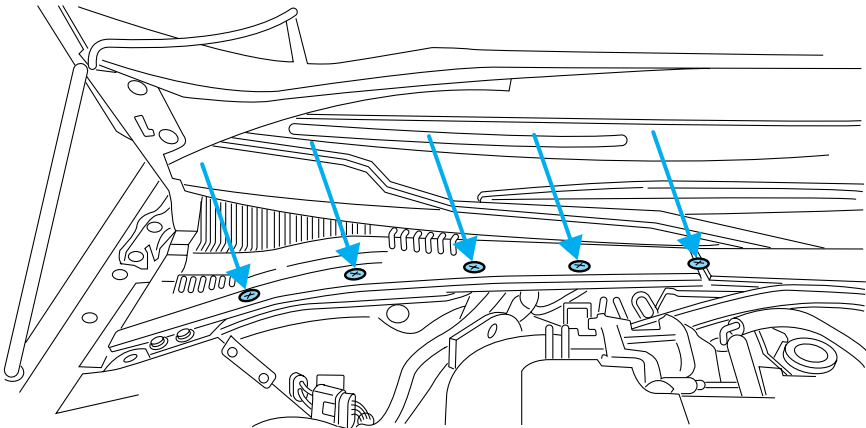

7. Insert the five pushpins that retain the passenger side portion of the cowl screen. Push up the center “button” of the pins, to insert the pins. Refasten the velcro at the rubber hood hinge cover.

8. Close the hood.

## Maintenance and care

### WINDSHIELD WIPER BLADES

Check the wiper blades at least twice a year or when they seem less effective. Substances such as tree sap and some hot wax treatments used by commercial car washes reduce the effectiveness of wiper blades.

In cold weather conditions, the wiper blades need to be thawed before operating in order to prevent premature wear to the wiper blades. Before operating the wiper blades in cold weather, refer to the *Electric window heaters* section of the *Controls and Features* chapter.

#### Checking the wiper blades

If the wiper blades do not wipe properly, clean both the windshield and wiper blades using undiluted windshield wiper solution or a mild detergent. Rinse thoroughly with clean water. To avoid damaging the blades, do not use fuel, kerosene, paint thinner or other solvents.

#### Changing the wiper blades

To replace the wiper blades:

1. Pull the passenger side wiper arm away from the windshield into the service position. Turn the blade at an angle from the wiper arm.

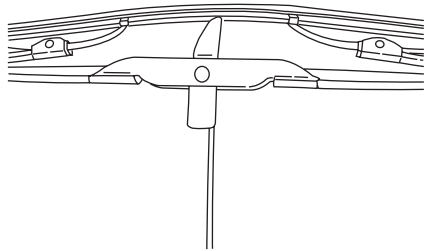

## Maintenance and care

2. Firmly press the release tab to unlock wiper blade from wiper arm.

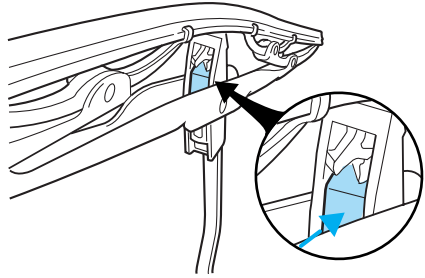

3. Pull the wiper blade down toward the windshield to remove it from the arm.

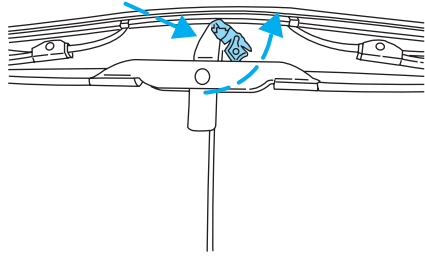

4. Attach the new wiper to the wiper arm and reposition the clip until it locks.

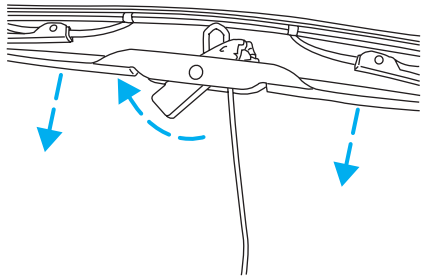

Repeat for driver's side wiper arm.

### INFORMATION ABOUT UNIFORM TIRE QUALITY GRADING

New vehicles are fitted with tires that have a rating on them called Tire Quality Grades. The Quality grades can be found where applicable on the tire sidewall between tread shoulder and maximum section width. For example:

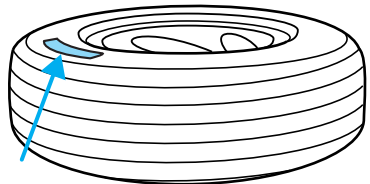

## Maintenance and care

### • Treadwear 200 Traction AA Temperature A

These Tire Quality Grades are determined by standards that the United States Department of Transportation has set.

Tire Quality Grades apply to new pneumatic tires for use on passenger cars. They do not apply to deep tread, winter-type snow tires, space-saver or temporary use spare tires, tires with nominal rim diameters of 10 to 12 inches or limited production tires as defined in Title 49 Code of Federal Regulations Part 575.104(c)(2).

**U.S. Department of Transportation-Tire quality grades:** The U.S. Department of Transportation requires Ford to give you the following information about tire grades exactly as the government has written it.

### Treadwear

The treadwear grade is a comparative rating based on the wear rate of the tire when tested under controlled conditions on a specified government test course. For example, a tire graded 150 would wear one and one-half (1 1/2) times as well on the government course as a tire graded 100. The relative performance of tires depends upon the actual conditions of their use, however, and may depart significantly from the norm due to variations in driving habits, service practices, and differences in road characteristics and climate.

### Traction AA A B C

The traction grades, from highest to lowest are AA, A, B, and C. Those grades represent the tire's ability to stop on wet pavement as measured under controlled conditions on specified government test surfaces of asphalt and concrete. A tire marked C may have poor traction performance.



The traction grade assigned to this tire is based on straight-ahead braking traction tests, and does not include acceleration, cornering, hydroplaning or peak traction characteristics.

### Temperature A B C

The temperature grades are A (the highest), B, and C, representing the tire's resistance to the generation of heat and its ability to dissipate heat when tested under controlled conditions on a specified indoor laboratory test wheel. Sustained high temperature can cause the material of the tire to degenerate and reduce tire life, and excessive temperature can lead to

## Maintenance and care

sudden tire failure. The grade C corresponds to a level of performance which all passenger car tires must meet under the Federal Motor Vehicle Safety Standard No. 109. Grades B and A represent higher levels of performance on the laboratory test wheel than the minimum required by law.



The temperature grade for this tire is established for a tire that is properly inflated and not overloaded. Excessive speed, underinflation, or excessive loading, either separately or in combination, can cause heat buildup and possible tire failure.

### SERVICING YOUR TIRES

#### Checking the tire pressure

- Use an accurate tire pressure gauge.
- Check the tire pressure when tires are cold, after the vehicle has been parked for at least one hour or has been driven less than 5 km (3 miles).
- Adjust tire pressure to recommended specifications found on the inflation placard.



Improperly inflated tires can affect vehicle handling and can fail suddenly, possibly resulting in loss of vehicle control.

## Maintenance and care

### Tire rotation

Because your vehicle's tires perform different jobs, they often wear differently. To make sure your tires wear evenly and last longer, rotate them as indicated in the scheduled maintenance guide. If you notice that the tires wear unevenly, have them checked.

- Four tire rotation

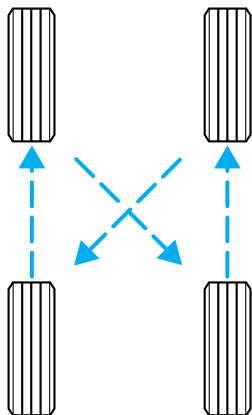

- Five tire rotation  
(with full-size spare tire)

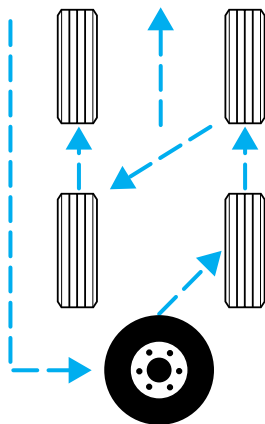

## Maintenance and care

- Unidirectional tire rotation

For vehicles equipped with original equipment unidirectional tires and full-size spare, your vehicle can be driven with the unidirectional full-size spare, rotating counter to the directional arrow on the tire sidewall.

Your unidirectional full-size spare tire is rotated for wear balance. Best performance may be achieved by remounting the tire to the wheel, if necessary, to permit tire rotation with the directional arrow on the tire sidewall.

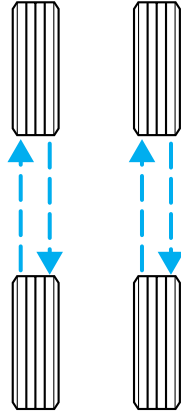

### Replacing the tires

Replace the tires when the wear band is visible through the tire treads.

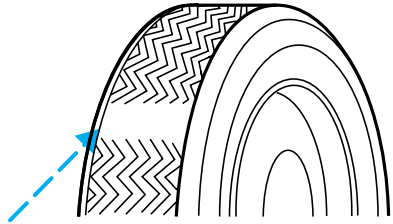

When replacing full size tires, never mix radial bias-belted, or bias-type tires. Use only the tire sizes that are listed on the Certification or Tire Label. Make sure that all tires are the same size, speed rating, and load-carrying capacity. Use only the tire combinations recommended on the label. If you do not follow these precautions, your vehicle may not drive properly and safely.



Make sure that all replacement tires are of the same size, type, load-carrying capacity and tread design (e.g., “All Terrain”, etc.), as originally offered by Ford.

## Maintenance and care



Failure to follow these precautions may adversely affect the handling of the vehicle and make it easier for the driver to lose control and roll over.

Tires that are larger or smaller than your vehicle's original tires may also affect the accuracy of your speedometer.

### SNOW TIRES AND CHAINS



Snow tires must be the same size and grade as the tires you currently have on your vehicle.

The tires on your vehicle have all weather treads to provide traction in rain and snow. However, in some climates, you may need to use snow tires or chains. If you need to use chains, it is recommended that steel wheels (of the same size and specifications) be used as chains may chip aluminum wheels.

Follow these guidelines when using snow tires and chains:

- Use only SAE Class S chains with P215/60R16 tires.
- Do not use tire chains with size P235/50R17 tires. Use of SAE Class S chains or other chain types may damage your vehicle.
- Install chains securely, verifying that the chains do not touch any wiring, brake lines or fuel lines.
- Drive cautiously. If you hear the chains rub or bang against your vehicle, stop and re-tighten the chains. If this does not work, remove the chains to prevent damage to your vehicle.
- If possible, avoid fully loading your vehicle.
- Remove the tire chains when they are no longer needed. Do not use tire chains on dry roads.
- The suspension insulation and bumpers will help prevent vehicle damage. Do not remove these components from your vehicle when using snow tires or chains.



## Maintenance and care

### WHAT YOU SHOULD KNOW ABOUT AUTOMOTIVE FUELS

#### Important safety precautions



Do not overfill the fuel tank. The pressure in an overfilled tank may cause leakage and lead to fuel spray and fire.



The fuel system may be under pressure. If the fuel filler cap is venting vapor or if you hear a hissing sound, wait until it stops before completely removing the fuel filler cap. Otherwise, fuel may spray out and injure you or others.



If you do not use the proper fuel filler cap, excessive pressure or vacuum in the fuel tank may damage the fuel system or cause the fuel cap to disengage in a collision, which may result in possible personal injury.



Automotive fuels can cause serious injury or death if misused or mishandled.



Gasoline may contain benzene, which is a cancer-causing agent.

Observe the following guidelines when handling automotive fuel:

- Extinguish all smoking materials and any open flames before fueling your vehicle.
- Always turn off the vehicle before fueling.
- Automotive fuels can be harmful or fatal if swallowed. Fuel such as gasoline is highly toxic and if swallowed can cause death or permanent injury. If fuel is swallowed, call a physician immediately, even if no symptoms are immediately apparent. The toxic effects of fuel may not be visible for hours.

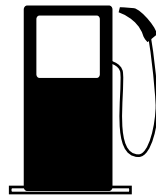

## Maintenance and care

- Avoid inhaling fuel vapors. Inhaling too much fuel vapor of any kind can lead to eye and respiratory tract irritation. In severe cases, excessive or prolonged breathing of fuel vapor can cause serious illness and permanent injury.
- Avoid getting fuel liquid in your eyes. If fuel is splashed in the eyes, remove contact lenses (if worn), flush with water for 15 minutes and seek medical attention. Failure to seek proper medical attention could lead to permanent injury.
- Fuels can also be harmful if absorbed through the skin. If fuel is splashed on the skin and/or clothing, promptly remove contaminated clothing and wash skin thoroughly with soap and water. Repeated or prolonged skin contact with fuel liquid or vapor causes skin irritation.
- Be particularly careful if you are taking “Antabuse” or other forms of disulfiram for the treatment of alcoholism. Breathing gasoline vapors, or skin contact could cause an adverse reaction. In sensitive individuals, serious personal injury or sickness may result. If fuel is splashed on the skin, promptly wash skin thoroughly with soap and water. Consult a physician immediately if you experience an adverse reaction.



When refueling always shut the engine off and never allow sparks or open flames near the filler neck. Never smoke while refueling. Fuel vapor is extremely hazardous under certain conditions. Care should be taken to avoid inhaling excess fumes.



The flow of fuel through a fuel pump nozzle can produce static electricity, which can cause a fire if fuel is pumped into an ungrounded fuel container.

Use the following guidelines to avoid static build-up when filling an ungrounded fuel container:

- Place approved fuel container on the ground.
- DO NOT fill a fuel container while it is in the vehicle.
- Keep the fuel pump nozzle in contact with the fuel container while filling.
- DO NOT use a device that would hold the fuel pump handle in the fill position.

### Fuel Filler Cap

Your fuel tank filler cap has an indexed design with a 1/8 turn on/off feature.

When fueling your vehicle:

1. Turn the engine off.
2. Carefully turn the filler cap counterclockwise 1/8 of a turn until it stops.
3. Pull to remove the cap from the fuel filler pipe.
4. To install the cap, align the tabs on the cap with the notches on the filler pipe.
5. Turn the filler cap clockwise 1/8 of a turn until it stops.

If the “Check Fuel Cap” indicator comes on and stays on after you start the engine, the fuel filler cap may not be properly installed. Turn off the engine, remove the fuel filler cap, align the cap properly and reinstall it.

**If you must replace the fuel filler cap, replace it with a fuel filler cap that is designed for your vehicle. The customer warranty may be void for any damage to the fuel tank or fuel system if the correct genuine Ford or Motorcraft fuel filler cap is not used.**



The fuel system may be under pressure. If the fuel filler cap is venting vapor or if you hear a hissing sound, wait until it stops before completely removing the fuel filler cap. Otherwise, fuel may spray out and injure you or others.



If you do not use the proper fuel filler cap, excessive pressure or vacuum in the fuel tank may damage the fuel system or cause the fuel cap to disengage in a collision, which may result in possible personal injury.

### Choosing the right fuel

Use only UNLEADED FUEL. The use of leaded fuel is prohibited by law and could damage your vehicle.

Do not use fuel containing methanol. It can damage critical fuel system components.

Your vehicle was not designed to use fuel or fuel additives with metallic compounds, including manganese-based compounds containing MMT.

## Maintenance and care

Repairs to correct the effects of using a fuel for which your vehicle was not designed may not be covered by your warranty.

### Octane recommendations

Your vehicle is designed to use “Premium” unleaded gasoline with an (R+M)/2 octane rating of 91 or higher for optimum performance.

The use of gasolines with lower octane ratings may degrade performance. We do not recommend the use of gasolines labeled as “Premium” in high altitude areas that are sold with octane ratings of less than 91.

Do not be concerned if your engine sometimes knocks lightly. However, if it knocks heavily under most driving conditions while you are using fuel with the recommended octane rating, see your dealer or a qualified service technician to prevent any engine damage.

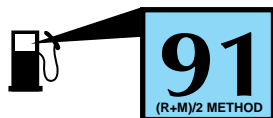

### Fuel quality

If you are experiencing starting, rough idle or hesitation driveability problems during a cold start, try a different brand of “Premium” unleaded gasoline. If the problems persist, see your dealer or a qualified service technician.

It should not be necessary to add any aftermarket products to your fuel tank if you continue to use high quality fuel of the recommended octane rating. Aftermarket products could cause damage to the fuel system. Repairs to correct the effects of using an aftermarket product in your fuel may not be covered by your warranty.

Many of the world’s automakers issued the World-wide Fuel Charter that recommends gasoline specifications to provide improved performance and emission control system protection for your vehicle. Gasolines that meet the World-wide Fuel Charter should be used when available. Ask your fuel supplier about gasolines that meet the World-wide Fuel Charter. In Canada, look for fuels that display the **Auto Makers’ Choice**™ logo.



### Cleaner air

Ford endorses the use of reformulated “cleaner-burning” gasolines to improve air quality.

### Running out of fuel

Avoid running out of fuel because this situation may have an adverse affect on powertrain components.

If you have run out of fuel:

- You may need to cycle the ignition from OFF to ON several times after refueling, to allow the fuel system to pump the fuel from the tank to the engine.
- Your “Check Engine” indicator may come on. For more information on the “Check Engine” indicator, refer to the *Instrumentation* chapter.

### Fuel Filter

For fuel filter replacement, see your dealer or a qualified service technician. Refer to the scheduled maintenance guide for the appropriate intervals for changing the fuel filter.

**Replace the fuel filter with an authorized Motorcraft part. The customer warranty may be void for any damage to the fuel system if an authorized Motorcraft fuel filter is not used.**

## ESSENTIALS OF GOOD FUEL ECONOMY

### Measuring techniques

Your best source of information about actual fuel economy is you, the driver. You must gather information as accurately and consistently as possible. Fuel expense, frequency of fillups or fuel gauge readings are NOT accurate as a measure of fuel economy. We do not recommend taking fuel economy measurements during the first 1 600 km (1 000 miles) of driving (engine break-in period). You will get a more accurate measurement after 3 000 km–5 000 km (2 000 miles–3 000 miles).

### Filling the tank

The advertised fuel capacity of the fuel tank on your vehicle is equal to the rated refill capacity of the fuel tank as listed in the *Refill Capacities* section of the *Capacities and specifications* chapter.

The advertised capacity is the amount of the indicated capacity and the empty reserve combined. Indicated capacity is the difference in the

## Maintenance and care

amount of fuel in a full tank and a tank when the fuel gauge indicates empty. Empty reserve is the small amount of fuel remaining in the fuel tank after the fuel gauge indicates empty.

**The amount of usable fuel in the empty reserve varies and should not be relied upon to increase driving range. When refueling your vehicle after the fuel gauge indicates empty, you might not be able to refuel the full amount of the advertised capacity of the fuel tank due to the empty reserve still present in the tank.**

For consistent results when filling the fuel tank:

- Turn the engine/ignition switch to the off position prior to refueling, an error in the reading will result if the engine is left running.
- Use the same filling rate setting (low — medium — high) each time the tank is filled.
- Allow no more than 2 automatic click-offs when filling.
- Always use fuel with the recommended octane rating.
- Use a known quality gasoline, preferably a national brand.
- Use the same side of the same pump and have the vehicle facing the same direction each time you fill up.
- Have the vehicle loading and distribution the same every time.

Your results will be most accurate if your filling method is consistent.

### Calculating fuel economy

1. Fill the fuel tank completely and record the initial odometer reading (in kilometers or miles).
2. Each time you fill the tank, record the amount of fuel added (in liters or gallons).
3. After at least three to five tank fill-ups, fill the fuel tank and record the current odometer reading.
4. Subtract your initial odometer reading from the current odometer reading.
5. Follow one of the simple calculations in order to determine fuel economy:

**Multiply liters used by 100, then divide by total kilometers traveled.**

**Divide total miles traveled by total gallons used.**

## Maintenance and care

Keep a record for at least one month and record the type of driving (city or highway). This will provide an accurate estimate of the vehicle's fuel economy under current driving conditions. Additionally, keeping records during summer and winter will show how temperature impacts fuel economy. In general, lower temperatures give lower fuel economy.

### **Driving style — good driving and fuel economy habits**

Give consideration to the lists that follow and you may be able to change a number of variables and improve your fuel economy.

#### ***Habits***

- Smooth, moderate operation can yield up to 10% savings in fuel.
- Steady speeds without stopping will usually give the best fuel economy.
- Idling for long periods of time (greater than one minute) may waste fuel.
- Anticipate stopping; slowing down may eliminate the need to stop.
- Sudden or hard accelerations may reduce fuel economy.
- Slow down gradually.
- Driving at reasonable speeds (traveling at 88 km/h [55 mph] uses 15% less fuel than traveling at 105 km/h [65 mph]).
- Revving the engine before turning it off may reduce fuel economy.
- Using the air conditioner or defroster may reduce fuel economy.
- You may want to turn off the speed control in hilly terrain if unnecessary shifting between third and fourth gear occurs. Unnecessary shifting of this type could result in reduced fuel economy.
- Warming up a vehicle on cold mornings is not required and may reduce fuel economy.
- Resting your foot on the brake pedal while driving may reduce fuel economy.
- Combine errands and minimize stop-and-go driving.

#### ***Maintenance***

- Keep tires properly inflated and use only recommended size.
- Operating a vehicle with the wheels out of alignment will reduce fuel economy.

## Maintenance and care

- Use recommended engine oil. Refer to *Lubricant Specifications*.
- Perform all regularly scheduled maintenance items. Follow the recommended maintenance schedule and owner maintenance checks found in your vehicle scheduled maintenance guide.

### Conditions

- Heavily loading a vehicle or towing a trailer may reduce fuel economy at any speed.
- Carrying unnecessary weight may reduce fuel economy (approximately 0.4 km/L [1 mpg] is lost for every 180 kg [400 lb] of weight carried).
- Adding certain accessories to your vehicle (for example bug deflectors, rollbars/light bars, running boards, ski/luggage racks) may reduce fuel economy.
- Using fuel blended with alcohol may lower fuel economy.
- Fuel economy may decrease with lower temperatures during the first 12–16 km (8–10 miles) of driving.
- Driving on flat terrain offers improved fuel economy as compared to driving on hilly terrain.
- Transmissions give their best fuel economy when operated in the top cruise gear and with steady pressure on the gas pedal.
- Close windows for high speed driving.

### EPA window sticker

Every new vehicle should have the EPA window sticker. Contact your dealer if the window sticker is not supplied with your vehicle. The EPA window sticker should be your guide for the fuel economy comparisons with other vehicles.

It is important to note the box in the lower left corner of the window sticker. These numbers represent the Range of L/100 km (MPG) expected on the vehicle under optimum conditions. Your fuel economy may vary depending upon the method of operation and conditions.

### EMISSION CONTROL SYSTEM

Your vehicle is equipped with various emission control components and a catalytic converter which will enable your vehicle to comply with applicable exhaust emission standards. To make sure that the catalytic converter and other emission control components continue to work properly:



## Maintenance and care

- Use only the specified fuel listed.
- Avoid running out of fuel.
- Do not turn off the ignition while your vehicle is moving, especially at high speeds.
- Have the items listed in your scheduled maintenance guide performed according to the specified schedule.

The scheduled maintenance items listed in the scheduled maintenance guide are essential to the life and performance of your vehicle and to its emissions system.

If other than Ford, Motorcraft or Ford-authorized parts are used for maintenance replacements or for service of components affecting emission control, such non-Ford parts should be equivalent to genuine Ford Motor Company parts in performance and durability.



Do not park, idle, or drive your vehicle in dry grass or other dry ground cover. The emission system heats up the engine compartment and exhaust system, which can start a fire.

Illumination of the “Check Engine” light, charging system warning light or the temperature warning light, fluid leaks, strange odors, smoke or loss of engine power, could indicate that the emission control system is not working properly.



Exhaust leaks may result in entry of harmful and potentially lethal fumes into the passenger compartment.

Do not make any unauthorized changes to your vehicle or engine. By law, vehicle owners and anyone who manufactures, repairs, services, sells, leases, trades vehicles, or supervises a fleet of vehicles are not permitted to intentionally remove an emission control device or prevent it from working. Information about your vehicle’s emission system is on the Vehicle Emission Control Information Decal located on or near the engine. This decal identifies engine displacement and gives some tune up specifications.

Please consult your “Warranty Guide” for complete emission warranty information.

## Maintenance and care

### Readiness for Inspection/Maintenance (I/M) testing

In some localities, it may be a legal requirement to pass an I/M test of the on-board diagnostics system. If your “Check Engine/Service Engine Soon” light is on, refer to the description in the *Warning Lights and Chimes* section of the *Instrumentation* chapter. Your vehicle may not pass the I/M test with the “Check Engine/Service Engine Soon” light on.

If the vehicle’s powertrain system or its battery has just been serviced, the on-board diagnostics system is reset to a “not ready for I/M test” condition. To ready the on-board diagnostics system for I/M testing, a minimum of 30 minutes of city and highway driving is necessary as described below:

- First, at least 10 minutes of driving on an expressway or highway.
- Next, at least 20 minutes driving in stop-and-go, city-type traffic with at least four idle periods.

Allow the vehicle to sit for at least eight hours without starting the engine. Then, start the engine and complete the above driving cycle. The engine must warm up to its normal operating temperature. Once started, do not turn off the engine until the above driving cycle is complete.

## BULBS

### Replacing exterior bulbs

Check the operation of the following lamps frequently:

- Headlamps
- Tail lamps
- Brakelamps
- High-mount brakelamp
- Turn signals
- Backup lamps
- License plate lamp
- Fog lamps

Do not remove lamp bulbs unless they will be replaced immediately. If a bulb is removed for an extended period of time, contaminants may enter the lamp housings and affect performance.

### Replacing headlamp bulbs

To remove the high or low beam headlamp bulb:

1. Make sure headlamp switch is in OFF position.
2. Lift the hood, push and release four tabs and remove the protective cover from the headlamps.
3. Disconnect the electrical connector from the bulb by pulling rearward.
4. Remove the old bulb from the lamp assembly by turning to unlock and pulling it straight out of the lamp assembly.

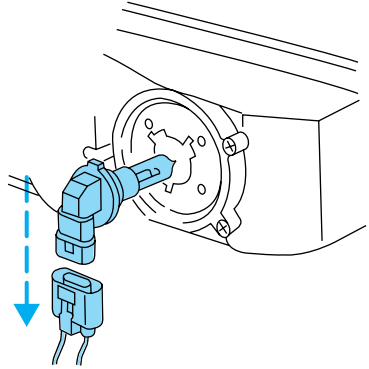

To install the new bulb:



Handle a halogen headlamp bulb carefully and keep out of children's reach. Grasp the bulb only by its plastic base and do not touch the glass. The oil from your hand could cause the bulb to break the next time the headlamps are operated.

1. Install the new bulb in lamp assembly by pushing straight in and turning to lock in position. You may need to turn the bulb slightly to align the grooves in the plastic base with the tabs in the lamp assembly.
2. Connect the electrical connector to the bulb.
3. Install the protective cover and secure with four tabs.
4. Turn the headlamps on and make sure they work properly. If the headlamp was correctly aligned before you changed the bulb, you should not need to align it again.

### Replacing foglamp bulbs

**The halogen bulb contains gas under pressure. The bulb may shatter if the glass envelope is scratched or if the bulb is dropped. Handle the bulb carefully. Grasp the bulb only by its base. Avoid touching the glass envelope.**

## Maintenance and care

1. Disconnect the electrical connector from the foglamp bulb.
2. Rotate the foglamp bulb counterclockwise and remove from the foglamp (the rear side of the foglamp is shown).
3. Install the foglamp bulb in foglamp by rotating clockwise.
4. Connect the electrical connector to the new foglamp bulb.

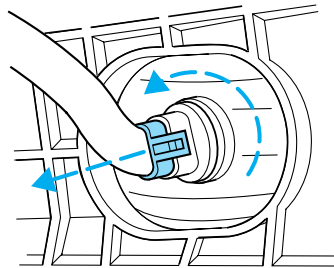

### ***Replacing front parking lamp/turn signal lamp bulbs***

For bulb replacement, see a dealer or qualified technician.

### ***Replacing high-mount brakelamp bulbs***

For bulb replacement, see a dealer or qualified technician.

### ***Replacing tail lamp/backup bulbs***

For bulb replacement, see a dealer or qualified technician.

### ***Replacing license plate lamp bulbs***

For bulb replacement, see a dealer or qualified technician.

## **Interior bulbs**

Check the operation of the following interior bulbs frequently:

- front map lamps
- Rear dome/reading lamp

For bulb replacement, see a dealer or qualified technician.

### ***Map lamps***

For bulb replacement, see a qualified service technician or your dealer.

## **Using the right bulbs**

Replacement bulbs are specified in the chart below. Headlamp bulbs must be marked with an authorized “D.O.T.” for North America and an “E” for Europe to assure lamp performance, light brightness and pattern and safe visibility. The correct bulbs will not damage the lamp assembly or void the lamp assembly warranty and will provide quality bulb burn time.

## Maintenance and care

Function	Trade Number
Headlamp low beam	9006
Headlamp high beam	9005
Park and turn lamp (front)	3157K
Side marker lamp (front)	168
Foglamp	9145
Tail lamp, brakelamp, side lamp	3157K
Rear turn lamp	3156K
Backup lamp	3157K
Tail/body side	161
Tail/deck (trunk) lid	161
License plate lamp	W5WL
High-mount brakelamp	3156K
Front door courtesy lamp	192
Map lamp (with moon roof)	212-2
Dome lamp (rear)	212-2
Map lamp (front)	212-2
Sun visor lighted mirror lamp	Part # E9SB-13465-BA
Glove compartment	194
Ashtray	194
Luggage compartment lamp	212-2
All replacement bulbs are clear in color except where noted.	
To replace all instrument panel lights - see your dealer.	

### AIMING THE HEADLAMPS

Your vehicle is equipped with a Vehicle Headlamp Aim Device (VHAD) on each headlamp body. Each headlamp may be properly aimed in the horizontal direction (left/right) and the vertical position (up/down).

A non-zero bubble reading does not necessarily indicate out-of-aim headlamps. If your vehicle is not positioned on a level surface, the slope will be included in the level indicator. Therefore, vertical headlamp adjustment should be performed only when beam direction appears to be incorrect.

The horizontal aim must be adjusted first. You will need one 4 mm wrench or socket to make the adjustments.

## Maintenance and care

If the vehicle has been in an accident, the vehicle's front structure should be properly aligned before aiming the headlamps.

### Horizontal aim adjustment

1. Park the vehicle on a level surface.
2. With the hood open, remove the protective cover, then locate the horizontal indicator and the adjusting screw.
3. Use a 4 mm wrench or socket to turn the horizontal adjusting screw until the end of the shaft within the clear tube lines up with the "0" reference mark on the indicator when viewed directly from above.

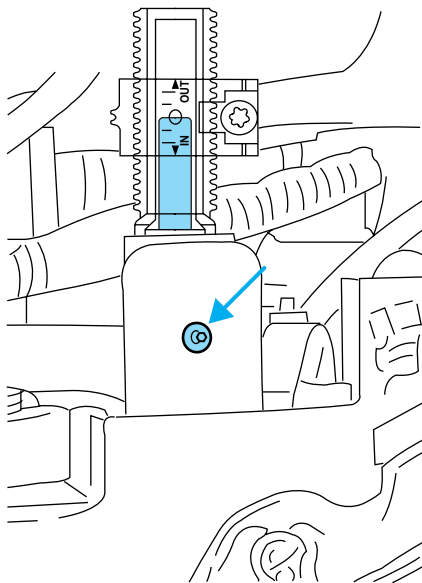

## Maintenance and care

### Vertical aim adjustment

1. Park the vehicle on a level surface.
2. With the hood open, remove protective cover, then locate the bubble level and the vertical adjustment screw.
3. The numbers shown on the vial indicate the directional change (up or down) of the vertical aim.
4. Use a 4 mm wrench or socket to turn the vertical adjusting screw until the bubble is below the “0” mark position when viewed directly from above.
5. Install protective cover.

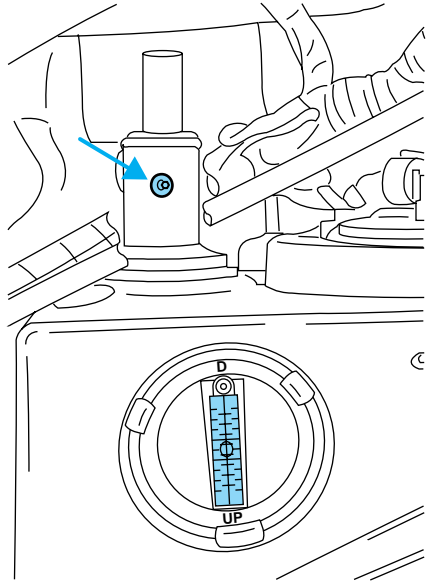

When the horizontal and vertical indicators are set to the “0” mark, the headlamp has been properly aimed.

### CLEANING AND CARING FOR YOUR VEHICLE

Refer to the Customer Assistance chapter for a list of Ford-approved cleaners, polishes and waxes.

#### Washing your vehicle

Wash your vehicle regularly with cold or lukewarm water. Never use strong detergents or soap. If your vehicle is particularly dirty, use a quality car wash detergent. Always use a clean sponge, washing glove or similar device and plenty of water for best results. To avoid spots, avoid washing when the hood is still warm, immediately after or during exposure to strong sunlight.

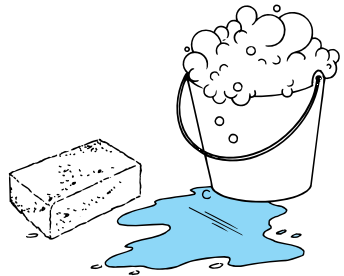

## Maintenance and care

During winter months, it is especially important to wash the vehicle on a regular basis. Large quantities of dirt and road salt are difficult to remove and also cause damage to the vehicle.

Any gasoline spilled on the vehicle or deposits such as bird droppings should be washed and sponged off as soon as possible. Deposits not removed promptly can cause damage to the vehicle's paintwork.

Remove any exterior accessories, such as antennas, before entering a car wash. If you have wax applied to the vehicle at a commercial car wash, it is recommended that you clean the wiper blades and windshield as described in *Cleaning the wiper blades and windshield*.

After washing, apply the brakes several times to dry them.

### Underbody

Flush the complete underside of vehicle frequently. Keep body drain holes unplugged. Inspect for road damage.

### Waxing your vehicle

Waxing your vehicle on a regular basis will reduce minor scratches and paint damage.

Wax when water stops beading on the surface. This could be every three or four months, depending on operating conditions.

Use only carnauba or synthetic-based waxes. Use a cleaning fluid with a clean cloth to remove any bugs before waxing your vehicle. Use tar remover to remove any tar spots.

Avoid getting wax on the windshield, or on any surfaces which appear coarse or bumpy. If you have wax applied at a commercial car wash, it is recommended that you clean the wiper blades and windshield as described in *Cleaning the wiper blades and windshield*.

### Repairing paint chips

Minor scratches or paint damage from road debris may be repaired with the Ultra Touch Prep and Finishing Kit (#F7AZ-19K507-BA), Lacquer Touch-up Paint (#ALBZ-19500-XXXXA), or Exterior Acrylic Spray Lacquer (#ALAZ-19500-XXXXA) from the Ford Car Care Chemicals line. Please note that the part numbers (shown as XXXX above) will vary with your vehicle's specific coloring. Observe the application instructions on the products.



## Maintenance and care

Remove particles such as bird droppings, tree sap, insect remains, tar spots, road salt and industrial fallout immediately.

### **Cleaning the wheels**

Wash with the same detergent as the body of your vehicle. Do not use acid-based or alcohol-based wheel cleaners, steel wool, fuel or strong detergents. Never use abrasives that will damage the finish of special wheel surfaces. Use a tar remover to remove grease and tar.

The brushes used in some automatic car washes may damage the finish on your wheels. Before going to a car wash, find out if the brushes are abrasive.

### **Cleaning non-painted plastic exterior parts**

Use vinyl cleaner for routine cleaning. Clean with a tar remover if necessary. Do not clean plastic parts with thinners, solvents or petroleum-based cleaners.

### **Cleaning mirrors**

Do not clean your mirrors with a dry cloth or abrasive materials. Use a soft cloth and mild detergent and water. Be careful when removing ice from outside mirrors because you may damage the reflective surface.

### **Cleaning the exterior lamps**

Wash with the same detergent as the exterior of your vehicle. If necessary, use a tar remover such as Ford Extra Strength Tar and Road Oil Remover (B7A-19520-AA).

To avoid scratching the lamps, do not use a dry paper towel, chemical solvents or abrasive cleaners.

### **Cleaning the wiper blades, windshield and rear window**

If the wiper blades do not wipe properly, clean the wiper blade rubber element with undiluted windshield washer solution or a mild detergent. To avoid damaging the blades, do not use fuel, kerosene, paint thinner or other solvents.

If the wiper still does not wipe properly, this could be caused by substances on the windshield or rear window such as tree sap and some hot wax treatments used by commercial car washes. Clean the outside of the windshield or rear window with a non-abrasive cleaner such as Ford Ultra-Clear Spray Glass Cleaner, (E4AZ-19C507-AA), available from your

## Maintenance and care

Ford Dealer. **Do not** use abrasive cleansers on glass as they may cause scratches. The windshield or rear window is clean if beads do not form when you rinse it with water. The windshield, rear window and wiper blades should be cleaned on a regular basis, and blades or rubber elements replaced when worn.

### Cleaning the engine

Engines are more efficient when they are clean because grease and dirt buildup keep the engine warmer than normal. When washing:

- Take care when using a power washer to clean the engine. The high pressure fluid could penetrate the sealed parts and cause damage.
- Do not spray with cold water to avoid cracking the engine block or other engine components.
- Never apply anything to the drive belt (including belt dressing).

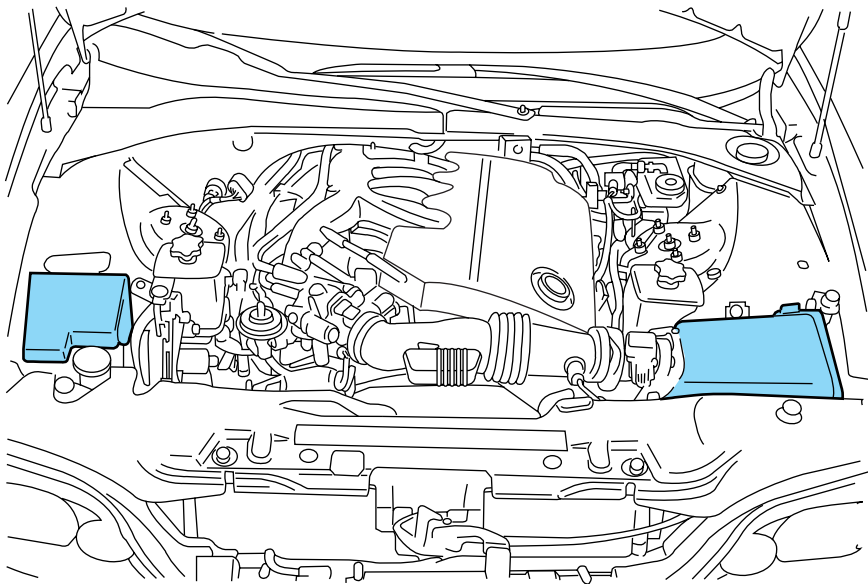

## Maintenance and care

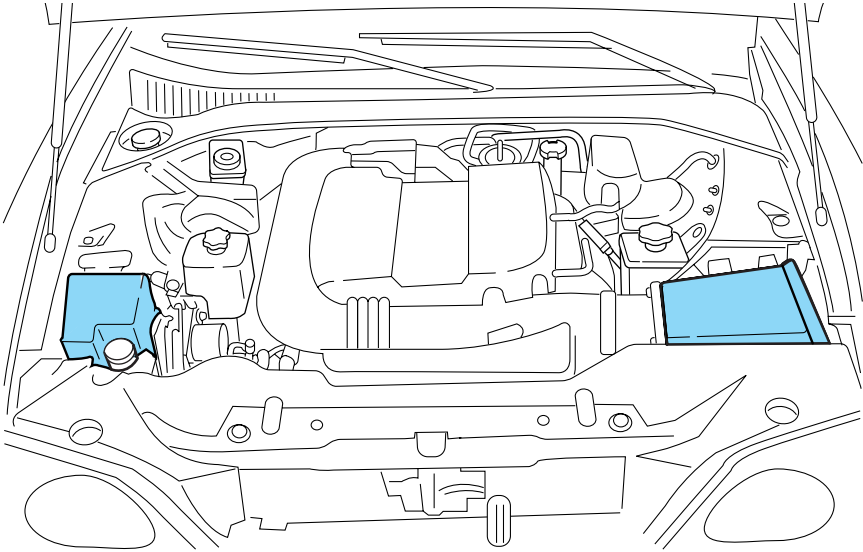

- Cover the highlighted areas to prevent water damage when cleaning the engine.
- Never wash or rinse the engine while it is running; water in the running engine may cause internal damage.

### **Cleaning the instrument panel**

Clean with a damp cloth, then dry with a dry cloth.

Avoid cleaner or polish that increases the gloss of the upper portion of the instrument panel. The dull finish in this area helps protect the driver from undesirable windshield reflection.



Do not use chemical solvents or strong detergents when cleaning the steering wheel or instrument panel to avoid contamination of the air bag system.

### ***Cleaning the instrument cluster lens***

Clean with a damp cloth, then dry with a dry cloth.

Do not use household or glass cleaners as these may damage the lens.

## Maintenance and care

### Cleaning seats equipped with side air bags

Remove dust and loose dirt with a whisk broom or a vacuum cleaner. Remove fresh spots immediately. Follow the directions that come with the cleaner. Do not saturate the seat cover with upholstery cleaner.



Do not use chemical solvents or strong detergents when cleaning the seat mounted side air bag. Such products could contaminate the side air bag system and affect performance of the side air bag in a collision.

### Woodtone trim

Wipe stains with a soft cloth and a multi-purpose cleaning solution.

### Inside windows

Use Ultra-Clear Spray Glass Cleaner (E4AZ-19C507-AA) for the inside windows if they become fogged.

### Cleaning and maintaining the safety belts

Clean the safety belts with a mild soap solution recommended for cleaning upholstery or carpets. Do not bleach or dye the belts, because these actions may weaken the belt webbing.

Check the safety belt system periodically to make sure there are no nicks, tears or cuts. If your vehicle has been involved in an accident, refer to the *Safety belt maintenance* section in the *Seating and safety restraints* chapter.

### Cleaning leather seats

To clean, simply use a soft cloth dampened with water and a mild soap. Wipe the leather again with a damp cloth to remove soap residue. Dry with a soft cloth. For tougher soiling concerns, Ford recommends using the Deluxe Leather Care Kit F8AZ-19G253-AA, which is available from your Ford Dealer. This mild cleaner and special pad, cleans the leather and maintains its natural beauty. Follow the instructions on the cleaner label. Regular cleaning of your leather upholstery helps maintain its resiliency and color.

**Do not use household cleaning products, alcohol solutions, solvents or cleaners intended for rubber, vinyl or plastics.**

## Maintenance and care

### **Cleaning the interior fabric**

Remove dust and loose dirt with a whisk broom or a vacuum cleaner. Remove fresh spots immediately. Do not use household or glass cleaners. These agents can stain and discolor the fabric. Use a mild soap and water solution if necessary.

## Capacities and specifications

### MOTORCRAFT PART NUMBERS

Component	3.0L-4V V6 engine	3.9L-4V V8 engine
Air filter element	FA-1679	FA-1679
Fuel filter	FG-986	FG-986
Battery (standard)	BXT-66-650	BXT-66-650
Battery (optional)	BXT-66-750	BXT-66-750
Oil filter	FL-400S	FL-2008
PCV valve	EV-243	N/A
Spark plugs*	AGSF-32FS	AGSP-32F

\* Refer to Vehicle Emissions Control Information (VECI) decal for spark plug information.

### REFILL CAPACITIES

Fluid	Ford Part Name	Application	Capacity
Brake fluid and clutch fluid (if equipped)	High Performance DOT 3 Motor Vehicle Brake Fluid <sup>1</sup>	All	Fill to MAX line on reservoir
Engine oil (includes filter change)	Motorcraft SAE 5W-20 Super Premium Motor Oil	3.0L-4V V6 engine	6.5L (6.9 quarts)
	Motorcraft SAE 5W-30 Super Premium Motor Oil	3.9L-4V V8 engine	5.7L (6.0 quarts)
Engine coolant <sup>2</sup>	Premium Engine Coolant	3.0L-4V V6 engine	10.6L (11.2 quarts)
		3.9L-4V V8 engine	11.3L (11.9 quarts)
Power steering fluid	Motorcraft MERCON® ATF	All	Fill to MAX line on reservoir
Engine cooling fan fluid	Motorcraft MERCON® ATF	All	Fill to MAX line on reservoir

## Capacities and specifications

Fluid	Ford Part Name	Application	Capacity
Rear axle <sup>3</sup>	Motorcraft SAE 75W-140 High Performance Synthetic Rear Axle Lubricant	All	1.4L (2.9-3.0 pints)
Fuel tank	N/A	All	68.2L (18.0 gallons)
Transmission fluid <sup>4</sup>	Motorcraft MERCON®V ATF	Automatic (5R55N)	11.2L (11.9 quarts) <sup>5</sup>
	Motorcraft MERCON® ATF	Manual	1.1L (2.3 pints) <sup>6</sup>
Windshield washer fluid	Ultra-Clear Windshield Washer Concentrate	All	Fill to line on reservoir

<sup>1</sup> Use only brake fluids certified to meet Ford specifications. Refer to *Lubricant Specifications* in this chapter. DOT 3 fluid is recommended. However, if DOT 3 is not available, DOT 4 fluid can be used.

<sup>2</sup> Use Ford Premium Engine Coolant (green in color). DO NOT USE Ford Extended Life Engine Coolant (orange in color). Refer to *Adding engine coolant, in the Maintenance and Care chapter*.

<sup>3</sup> Your vehicle's rear axle is filled with a synthetic rear axle lubricant and is considered lubricated for life. These lubricants do not need to be checked or changed unless a leak is suspected, service is required or the axle assembly has been submerged in water. The axle lubricant should be changed any time the rear axle has been submerged in water. Fill 6 mm to 14 mm (1/4 inch to 9/16 inch) below bottom of fill hole.

<sup>4</sup> Ensure the correct automatic transmission fluid is used. MERCON® and MERCON® V are not interchangeable. DO NOT MIX MERCON® and MERCON® V. Refer to the scheduled maintenance guide to determine the correct service interval.

<sup>5</sup> Approximate dry capacity, includes cooler and tubes. Fluid level should be checked by a qualified service technician.

<sup>6</sup> Service refill capacity is determined by filling the transmission to the bottom of the filler hole with the vehicle on a level surface.

# Capacities and specifications

## LUBRICANT SPECIFICATIONS

Item	Ford part name	Ford part number	Ford specification
Brake fluid and clutch fluid (if equipped)	High Performance DOT 3 Motor Vehicle Brake Fluid <sup>1</sup>	C6AZ-19542-AB	ESA-M6C25-A and DOT 3
Door weatherstrips	Silicone Lubricant	F7AZ-19G208-BA and F5AZ-19553-AA	ESR-M13P4-A
Door latch, hood latch, auxiliary hood latch, door hinges, striker plates, seat tracks and fuel filler door hinge	Multi-Purpose Grease	D0AZ-19584-AA or F5AZ-19G209-AA	ESB-M1C93-B or ESR-M1C159-A
Engine coolant	Ford Premium Engine Coolant (green colored)	VC-4- A (in Canada, Motorcraft CXC-10)	ESE-M97B44-A
Engine oil 3.0L - 4V V6 Engine	Motorcraft SAE 5W-20 Super Premium Motor Oil	XO-5W20-QSP	WSS-M2C153-H with API Certification Mark
Engine oil 3.9L - 4V V8 Engine	SAE 5W-30 Super Premium Motor Oil	XO-5W30-QSP	WSS-M2C153-G with API Certification Mark
Lock cylinders	Motorcraft Penetrating and Lock Lubricant	Motorcraft XL-1	none
Power steering and engine cooling fan fluid	Motorcraft MERCON® ATF	XT-2-QDX	MERCON®



## Capacities and specifications

Item	Ford part name	Ford part number	Ford specification
Rear Axle Lubricant	Motorcraft SAE 75W-140 High Performance Synthetic Rear Axle Lubricant <sup>2</sup>	F1TZ-19580-B	WSL-M2C192-A
Automatic transmission fluid	Motorcraft MERCON®V ATF <sup>3</sup>	XT-5-QM	MERCON®V
Manual transmission fluid	Motorcraft MERCON® ATF <sup>3</sup>	XT-2-QDX	MERCON®
Windshield washer fluid	Ultra-clear Windshield Washer Concentrate	C9AZ-19550-AC	ESR-M17P5-A

<sup>1</sup> Use only brake fluids certified to meet Ford specifications. DOT 3 fluid is recommended. However, if DOT 3 is not available, DOT 4 fluid can be used.

<sup>2</sup> Ford design rear axles contain a synthetic lubricant that does not require changing unless the axle has been submerged in water.

<sup>3</sup> Ensure the correct automatic transmission fluid is used. MERCON® and MERCON® V are not interchangeable. DO NOT MIX MERCON® and MERCON® V. Refer to the scheduled maintenance guide to determine the correct service interval.

### ENGINE DATA

Engine	3.0L-4V V6 engine	3.9L-4V V8 engine
Displacement	2 968 cc (181 cid)	3 949 cc (241 cid)
Required fuel	91 octane	91 octane
Firing order	1-4-2-5-3-6	1-5-4-2-6-3-7-8
Spark plug gap	1.30-1.45 mm (0.051-0.057 inch)	0.99-1.09 mm (0.039-0.043 inch)
Ignition system	Coil on plug	Coil on plug
Compression ratio	10.5:1	10.55:1

## Capacities and specifications

### VEHICLE DIMENSIONS

Vehicle dimensions	mm (in)
(1) Overall length	4 925 mm (193.9 in)
(2) Overall width	1 859 mm (73.2 in)
(3) Overall height	1 426 mm (56.1 in)
(4) Wheelbase	2 909 mm (114.5 in)
(5) Track - Front	1 537 mm (60.5 in)
(5) Track - Rear	1 544 mm (60.8 in)

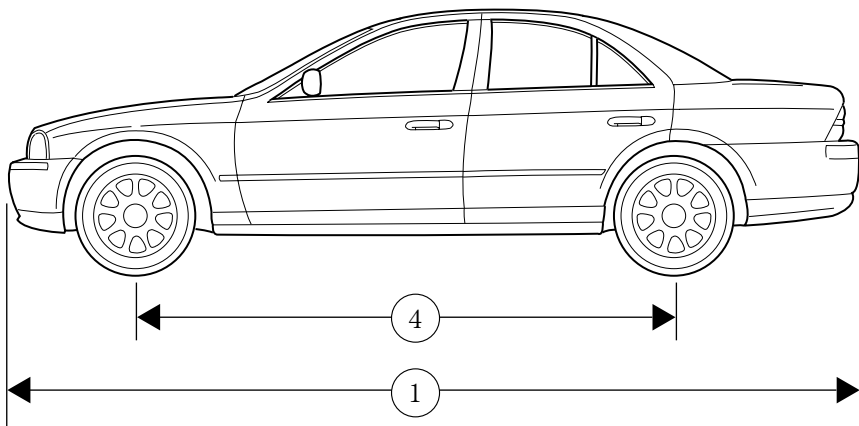
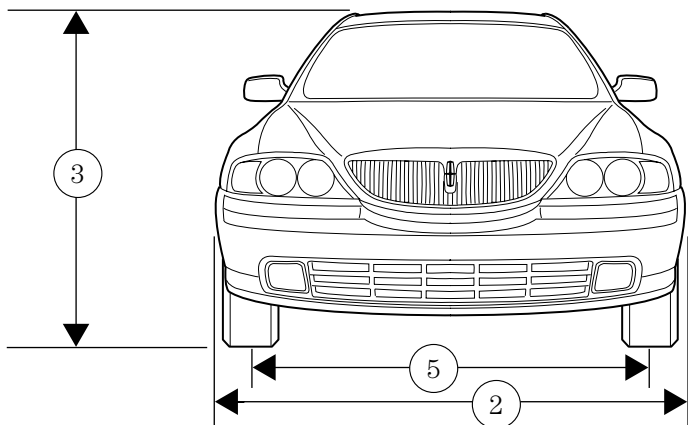

# Capacities and specifications

## IDENTIFYING YOUR VEHICLE

### Certification label

The National Highway Traffic Safety Administration Regulations require that a Certification Label be affixed to a vehicle and prescribe where the Certification Label may be located. The Certification Label is located on the driver's side A-pillar.

<b>MFD. BY FORD MOTOR CO. IN U.S.A.</b>		
DATE: XXXXX	GVWR:XXXXXXXXXXXX	
FRONT GAWR: XXXXXX/XXXXXXXX		
REAR GAWR: XXXXXX/XXXXXXXX		
THIS VEHICLE CONFORMS TO ALL APPLICABLE FEDERAL MOTOR VEHICLE SAFETY, BUMPER, AND THEFT PREVENTION STANDARDS IN EFFECT ON THE DATE OF MANUFACTURE SHOWN ABOVE.		
VIN: XXXXXXXXXXXXXXXXXXXX		XXXXX XXXXX
TYPE: XXXXXXXXXXXXXXXX		
		
EXT PNT: XXXXX XXXXX	RC: XX	DSO: XXXX
BAR   INT TR   TP/PS   R   AXLE   TR   SPR		
X   XX   XXX X   XX   X   XXXX		
UPC VF85B-1520472-AB		

### Vehicle identification number

The vehicle identification number is attached to a metal tag and is located on the driver side instrument panel. (Please note that in the graphic XXXX is representative of your vehicle identification number.)

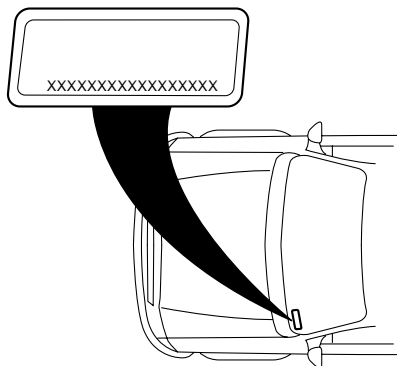

### Engine number

The engine number (the last eight numbers of the vehicle identification number) is stamped on the engine block, transmission, frame and transfer case (if equipped).

## Customer assistance

### Ford Extended Service Plan

You can get more protection for your new car or light truck by purchasing Ford Extended Service Plan (Ford ESP) coverage. Ford ESP is an optional service contract which is backed by Ford Motor Company or Ford Motor Service Company (in the U.S.) and Ford of Canada (in Canada). It provides the following:

- benefits during the warranty period depending on the plan you purchase (such as: reimbursement for rentals; coverage for certain maintenance and wear items)
- protection against covered repair costs after your Bumper to Bumper Warranty expires

You may purchase Ford ESP from any participating Ford and Lincoln Mercury and Ford of Canada dealer. There are several plans available in various time, distance and deductible combinations which can be tailored to fit your own driving needs. Ford ESP also offers reimbursement benefits for towing and rental coverage.

When you buy Ford ESP, you receive Peace-of-Mind protection throughout the United States and Canada, provided by a network of more than 5,000 participating Ford or Lincoln Mercury and Ford of Canada dealers.

If you did not take advantage of the Ford Extended Service Plan at the time of purchasing your vehicle, you may still be eligible. Please contact your dealer for further information. Since this information is subject to change, please ask your dealer for complete details about Ford Extended Service Plan coverage options, or visit the Ford ESP website at [www.ford-esp.com](http://www.ford-esp.com).

### Getting the service you need

#### At home

Ford Motor Company and Ford of Canada have authorized dealerships to service your vehicle. When you need warranty repairs your selling dealer would like you to return to it for that service, but you may also take your vehicle to another Ford Motor Company or Ford of Canada dealership authorized for warranty repairs. Certain warranty repairs require special training though, so not all dealers are authorized to perform all warranty repairs. That means that depending on the warranty repair needed, the vehicle may need to be taken to another dealer. If a particular dealership can not assist you, then contact the Customer Relationship Center.

## Customer assistance

If you have questions or concerns, or are unsatisfied with the service you are receiving, follow these steps:

1. Contact your Sales Representative or Service Advisor at your selling/servicing dealership.
2. If your inquiry or concern remains unresolved, contact the Sales Manager or Service Manager at the dealership.
3. If the inquiry or concern cannot be resolved at the dealership level, please contact the Ford Customer Relationship Center.

Ford Motor Company and Ford of Canada dealerships also carry quality parts and accessories, providing you with equipment reliability.

### Away from home

If you own a Ford or Mercury vehicle and are away from home when your vehicle needs service, or if you need more help than the dealership could provide, after following the steps described above, contact the Ford Customer Relationship Center to find an authorized dealership to help you. In the United States:

Ford Motor Company  
Customer Relationship Center  
16800 Executive Plaza Drive  
P.O. Box 6248  
Dearborn, Michigan 48121  
1-800-392-3673 (FORD)  
(TDD for the hearing impaired: 1-800-232-5952)

In Canada:  
Customer Relationship Centre  
Ford Motor Company of Canada, Limited  
P.O. Box 2000  
Oakville, Ontario L6J 5E4  
1-800-565-3673 (FORD)

## Customer assistance

If you own a Lincoln vehicle and are away from home when your vehicle needs service, or if you need more help than the dealership could provide, after following the steps described above, contact the Ford Customer Relationship Center to find an authorized dealership to help you. In the United States:

Ford Motor Company  
Customer Relationship Center  
16800 Executive Plaza Drive  
P.O. Box 6248  
Dearborn, Michigan 48121  
1-800-521-4140  
(TDD for the hearing impaired: 1-800-232-5952)

In Canada:  
Customer Relationship Centre  
Ford Motor Company of Canada, Limited  
P.O. Box 2000  
Oakville, Ontario L6J 5E4  
1-800-565-3673 (FORD)

In order to help you service your Ford or Lincoln Mercury vehicle, please have the following information available when contacting a Customer Relationship Center:

- Your telephone number (home and business)
- The name of the dealer and the city where the dealership is located
- The year and make of your vehicle
- The date of vehicle purchase
- The current odometer reading
- The vehicle identification number (VIN)

If you still have a complaint involving a warranty dispute, you may wish to contact the Dispute Settlement Board (U.S.) or the Canadian Motor Vehicle Arbitration Plan (CAMVAP), available in all of Canada (except Quebec).

In some states (in the U.S.) you must directly notify Ford in writing before pursuing remedies under your state's warranty laws. Ford is also allowed a final repair attempt in some states.

In the United States, a warranty dispute must be submitted to the Dispute Settlement Board before taking action under the Magnuson-Moss Warranty Act, or to the extent allowed by state law, before pursuing

## Customer assistance

replacement or repurchase remedies provided by certain state laws. This dispute handling procedure is not required prior to enforcing state created rights or other rights which are independent of the Magnuson-Moss Warranty Act or state replacement or repurchase laws.

### **THE DISPUTE SETTLEMENT BOARD (U.S. ONLY)**

The Dispute Settlement Board is:

- an independent, third-party arbitration program for warranty disputes
- available free to owners and lessees of qualifying Ford Motor Company vehicles

The Dispute Settlement Board may not be available in all states. Ford Motor Company reserves the right to change eligibility limitations, modify procedures and/or to discontinue this service without notice and without incurring obligations per applicable state law.

### **What kinds of cases does the Board review?**

Unresolved warranty repair concerns or vehicle performance as designed concerns on Ford and Lincoln Mercury cars and Ford and Lincoln Mercury light trucks which are within the terms of any applicable written new vehicle warranty are eligible for review, except those involving:

- a non-Ford product
- a non-Ford dealership
- sales disputes between customer and dealer except those associated with warranty repairs or concerns with the vehicle's performance as designed
- a request for reimbursement of consequential expenses unless a service or product concern is being reviewed
- items not covered by the New Vehicle Limited Warranty (including maintenance and wear items)
- alleged personal injury/property damage claims
- cases currently in litigation
- vehicles not used primarily for family, personal or household purposes (except in states where the Dispute Settlement Board is required to review commercial vehicles)
- vehicles with non-U.S. warranties

## Customer assistance

Concerns are ineligible for review if the New Vehicle Limited Warranty has expired at receipt of your application and, in certain states eligibility is dependent upon the customer's possession of the vehicle.

Eligibility may differ according to state law. For example, see the unique brochures for California, West Virginia, Georgia and Wisconsin purchasers/lessees.

### **Board membership**

The Board consists of:

- three consumer representatives
- a Ford or Lincoln Mercury dealership representative

Consumer candidates for Board membership are recruited and trained by an independent consulting firm. The dealership Board member is chosen from Ford and Lincoln Mercury dealership management, recognized for their business leadership qualities.

### ***What the Board needs***

To have your case reviewed you must complete the application in the DSB brochure and mail it to the address provided on the application form. Some states will require you to use certified mail, with return receipt requested.

Your application is reviewed and, if it is determined to be eligible, you will receive an acknowledgment indicating:

- the file number assigned to your application
- the toll-free phone number of the DSB's independent administrator

Your dealership and a Ford Motor Company representative will then be asked to submit statements.

To properly review your case, the Board needs the following information:

- legible copies of all documents and maintenance or repair orders relevant to the case
- the year, make, model, and Vehicle Identification Number (VIN) listed on your vehicle ownership license
- the date of repair(s) and mileage at the time of occurrence(s)
- the current mileage
- the name of the dealer(s) who sold or serviced the vehicle
- a brief description of your unresolved concern



## Customer assistance

- a brief summary of the action taken by the dealer(s) and Ford Motor Company
- the names (if known) of all the people you contacted at the dealership(s)
- a description of the action you expect to resolve your concern

You will receive a letter of explanation if your application does not qualify for Board review.

### ***Oral presentations***

If you would like to make an oral presentation, indicate YES to question #6 on the application. While it is your right to make an oral presentation before the Board, this is not a requirement and the Board will decide the case whether or not an oral presentation is made. Oral presentation may be requested by the Board as well.

### ***Making a decision***

Board members review all available information related to each complaint, including oral presentations, and arrive at a fair and impartial decision. Board review may be terminated at any time by either party.

Every effort is made to decide the case within 40 days of the date that all requested information is received by the Board. Since the Board generally meets once a month, it may take longer for the Board to consider some cases.

After a case is reviewed, the Board mails you a decision letter and a form on which to accept or reject the Board's decision. The decisions of the Board are binding on Ford (and, in some cases, on the dealer) but not on consumers who are free to pursue other remedies available to them under state or federal law.

### **To Request a DSB Brochure/Application**

For a brochure/application, speak to your dealer or write/call to the Board at the following address/phone number:

Dispute Settlement Board  
P.O. Box 5120  
Southfield, MI 48086-5120  
1-800-428-3718

## Customer assistance

You may also contact the North American Customer Relationship Center at 1-800-392-3673 (Ford), TDD for the hearing impaired: 1-800-232-5952 or by writing to the Center at the following address:

Ford Motor Company  
Customer Relationship Center  
16800 Executive Plaza Drive  
P.O. Box 6248  
Dearborn, Michigan 48121

### **UTILIZING THE MEDIATION/ARBITRATION PROGRAM (CANADA ONLY)**

In those cases where you continue to feel that the efforts by Ford and the dealer to resolve a factory-related vehicle service concern have been unsatisfactory, Ford of Canada participates in an impartial third party mediation/arbitration program administered by the Canadian Motor Vehicle Arbitration Plan (CAMVAP).

The CAMVAP program is a straight-forward and relatively speedy alternative to resolve a disagreement when all other efforts to produce a settlement have failed. This procedure is without cost to you and is designed to eliminate the need for lengthy and expensive legal proceedings.

In the CAMVAP program, impartial third-party arbitrators conduct hearings at mutually convenient times and places in an informal environment. These impartial arbitrators review the positions of the parties, make decisions and, when appropriate, render awards to resolve disputes. CAMVAP decisions are fast, fair, and final; the arbitrator's award is binding both to you and Ford of Canada.

CAMVAP services are available in all territories and provinces, except Quebec. For more information, without charge or obligation, call your CAMVAP Provincial Administrator directly at 1-800-207-0685.

### **GETTING ASSISTANCE OUTSIDE THE U.S. AND CANADA**

Before exporting your vehicle to a foreign country, contact the appropriate foreign embassy or consulate. These officials can inform you of local vehicle registration regulations and where to find unleaded fuel.

If you cannot find unleaded fuel or can only get fuel with an anti-knock index lower than is recommended for your vehicle, contact a district or owner relations/customer relationship office.

## Customer assistance

The use of leaded fuel in your vehicle without proper conversion may damage the effectiveness of your emission control system and may cause engine knocking or serious engine damage. Ford Motor Company/Ford of Canada is not responsible for any damage caused by use of improper fuel.

In the United States, using leaded fuel may also result in difficulty importing your vehicle back into the U.S.

If your vehicle must be serviced while you are traveling or living in Central or South America, the Caribbean, or the Middle East, contact the nearest Ford dealership. If the dealership cannot help you, write or call:

FORD MOTOR COMPANY  
WORLDWIDE DIRECT MARKET OPERATIONS

1555 Fairlane Drive  
Fairlane Business Park #3  
Allen Park, Michigan 48101  
U.S.A.  
Telephone: (313) 594-4857  
FAX: (313) 390-0804

If you are in another foreign country, contact the nearest Ford dealership. If the dealership employees cannot help you, they can direct you to the nearest Ford affiliate office.

If you buy your vehicle in North America and then relocate outside of the U.S. or Canada, register your vehicle identification number (VIN) and new address with Ford Motor Company Worldwide Direct Market Operations.

### **FORD CAR CARE PRODUCTS FOR YOUR VEHICLE**

Ford has many quality products available from your dealer to clean your vehicle and protect its finishes. For best results, use the following or products of equivalent quality:

Ford Custom Clearcoat Polish\*

Ford Custom Silicone Gloss Polish

Ford Custom Vinyl Protectant\*

Ford Deluxe Leather and Vinyl Cleaner

Ford Extra Strength Tar and Road Oil Remover\*

Ford Extra Strength Upholstery Cleaner

Ford Metal Surface Cleaner

## Customer assistance

Ford Multi-Purpose Cleaner\*

Motorcraft Car Wash Concentrate

Motorcraft Carlite Glass Cleaner

Ford Spot and Stain Remover\*

Ford Super Premium Tire and Trim Dressing

Ford Triple Clean

Ford Ultra-Clear Spray Glass Cleaner

\* May be sold with the Motorcraft name

### **FORD ACCESSORIES FOR YOUR VEHICLE**

A wide selection of Ford accessories are available for your vehicle through your local authorized Lincoln Mercury dealer. These quality accessories have been specifically engineered to fulfill your automotive needs; they are custom designed to complement the style and aerodynamic appearance of your vehicle. In addition, each accessory is made from high quality materials and meets or exceeds Ford's rigid engineering and safety specifications. Ford accessories are warranted for up to 12 months or 20,000 km (12,000 miles) on all cars unless the accessory is installed on a new vehicle, then the warranty becomes the balance of the new vehicle's warranty or the accessories warranty, whichever is greater. See your dealer for complete warranty information and availability.

**Not all accessories are available for all models.**

#### **Vehicle Security**

Styled wheel locks

Vehicle security systems

#### **Comfort and convenience**

Cargo nets

Cargo organizers (trunk)

Cargo tray

Electrochromic compass inside mirror

Engine block heaters

Manual gear shift knob (woodgrain)

### Travel equipment

Removable luggage rack

Removable luggage rack adapters

### Protection and appearance equipment

Air bag anti-theft locks

Car cover

Carpet floor mats

Emergency kit

First aid kit

Front end covers (mini)

HomeLink®

Molded splash guards

Molded vinyl floor mats

Moon roof air deflector

Park pilot/reverse park aid

Rear spoiler

Wood/Leather steering wheel

For maximum vehicle performance, keep the following information in mind when adding accessories or equipment to your vehicle:

- When adding accessories, equipment, passengers and luggage to your vehicle, do not exceed the total weight capacity of the vehicle or of the front or rear axle (GVWR or GAWR as indicated on the Safety compliance certification label). Consult your dealer for specific weight information.
- The Federal Communications Commission (FCC) and Canadian Radio Telecommunications Commission (CRTC) regulate the use of mobile communications systems - such as two-way radios, telephones and theft alarms - that are equipped with radio transmitters. Any such equipment installed in your vehicle should comply with FCC or CRTC regulations and should be installed only by a qualified service technician.
- Mobile communications systems may harm the operation of your vehicle, particularly if they are not properly designed for automotive use or are not properly installed. When operated, such systems may

## Customer assistance

cause the engine to stumble or stall or cause the transmission to be damaged or operate improperly. In addition, such systems may be damaged or their performance may be affected by operating your vehicle. (Citizens band [CB] transceivers, garage door openers and other transmitters with outputs of five watts or less will not ordinarily affect your vehicle's operation.)

- Ford cannot assume responsibility for any adverse effects or damage that may result from the use of such equipment.

### **ORDERING ADDITIONAL OWNER'S LITERATURE**

To order the publications in this portfolio:

Make checks payable to:

HELM, INCORPORATED

P.O. Box 07150

Detroit, Michigan 48207

**For a free publication catalog, order toll free: 1-800-782-4356**

Monday-Friday 8:00 a.m. - 6:00 p.m. EST,  
for credit card holders only

### **Obtaining a French owner's guide**

French Owner's Guides can be obtained from your dealer or by writing to Ford Motor Company of Canada, Limited, Service Publications, P.O. Box 1580, Station B, Mississauga, Ontario L4Y 4G3.

### IN CALIFORNIA (U.S. ONLY)

California Civil Code Section 1793.2(d) requires that, if a manufacturer or its representative is unable to repair a motor vehicle to conform to the vehicle's applicable express warranty after a reasonable number of attempts, the manufacturer shall be required to either replace the vehicle with one substantially identical or repurchase the vehicle and reimburse the buyer in an amount equal to the actual price paid or payable by the consumer (less a reasonable allowance for consumer use). The consumer has the right to choose whether to receive a refund or replacement vehicle.

California Civil Code Section 1793.22(b) presumes that the manufacturer has had a reasonable number of attempts to conform the vehicle to its applicable express warranties if, within the first 18 months of ownership of a new vehicle or the first 29 000 km (18 000 miles), whichever occurs first:

1. Two or more repair attempts are made on the same nonconformity likely to cause death or serious bodily injury OR
2. Four or more repair attempts are made on the same nonconformity (a defect or condition that substantially impairs the use, value or safety of the vehicle) OR
3. The vehicle is out of service for repair of nonconformities for a total of more than 30 calendar days (not necessarily all at one time)

In the case of 1 or 2 above, the consumer must also notify the manufacturer of the need for the repair of the nonconformity at the following address:

16800 Executive Plaza Drive  
Mail Drop 3NE-B  
Dearborn, MI 48126

## Reporting safety defects

### REPORTING SAFETY DEFECTS (U.S. ONLY)

If you believe that your vehicle has a defect that could cause a crash, or could cause injury or death, you should immediately inform the National Highway Traffic Safety Administration (NHTSA) in addition to notifying Ford Motor Company.

*Ford Motor Company*

If NHTSA receives similar complaints, it may open an investigation, and if it finds that a safety defect exists in a group of vehicles, it may order a recall and remedy campaign. However, NHTSA cannot become involved in individual problems between you, your dealer or Ford Motor Company.

To contact NHTSA, you may either call the Auto Safety Hotline toll-free at 1-800-424-9393 (202-366-0123 in the Washington D.C. area) or write to:

NHTSA  
U.S. Department of Transportation  
400 Seventh Street  
Washington D.C. 20590

You can also obtain other information about motor vehicle safety from the Hotline.



**A**

- Accessory delay .....91
- AdvanceTrac .....148
- Air bag supplemental restraint system .....122, 126
  - and child safety seats .....124
  - description .....122, 126
  - disposal .....129
  - driver air bag .....124, 127
  - indicator light .....11, 126, 128
  - operation .....124, 127
  - passenger air bag .....124, 127
  - side air bag .....126
- Air cleaner filter .....212–213, 246
- Air conditioning .....31
  - automatic temperature control system .....31
- Air filter, cabin .....214
- Antifreeze
  - (see Engine coolant) .....201
- Anti-lock brake system
  - (see Brakes) .....144–145
- Anti-theft system .....99
  - arming the system .....99
  - disarming a triggered system ..99
- Audio system (see Radio) ...42, 54
- Automatic transmission .....150
  - driving an automatic overdrive .....151
  - fluid, adding .....208
  - fluid, checking .....208
  - fluid, refill capacities .....246
  - fluid, specification .....249
- Axle
  - lubricant specifications ..248–249
  - refill capacities .....246

**B**

- Battery .....210
  - acid, treating emergencies .....210
  - charging system warning light .....10
  - jumping a disabled battery ...185
  - maintenance-free .....210
  - replacement, specifications ..246
  - servicing .....210
- Belt minder .....118
- Brakes .....144
  - anti-lock .....144–145
  - anti-lock brake system (ABS) warning light .....9, 144
  - brake warning light .....10
  - fluid, checking and adding ...199
  - fluid, refill capacities .....246
  - fluid, specifications .....248–249
  - lubricant specifications ..248–249
  - parking .....145
  - shift interlock .....150
- Break-in period .....3

**C**

- Capacities for refilling fluids ....246
- Cassette tape player .....54
- CD changer .....67
- Certification Label .....251
- Child safety restraints .....130
  - child safety belts .....130
- Child safety seats .....130–131
  - attaching with tether straps ..134
  - in front seat .....132
  - in rear seat .....132
  - LATCH .....136
- Cleaning your vehicle .....239

# Index

- engine compartment .....242
- exterior .....240
- exterior lamps .....241
- instrument cluster lens .....243
- instrument panel .....243
- interior .....244–245
- mirrors .....241
- plastic parts .....241
- safety belts .....244
- washing .....239
- waxing .....240
- wheels .....241
- windows .....244
- wiper blades .....241
- woodtone trim .....244
  
- Climate control (see Air conditioning or Heating) .....31
- Clock .....50, 66
- Clutch
  - fluid .....200
  - operation while driving .....160
  - recommended shift speeds ....161
- Compass, electronic .....84
  - calibration .....85
  - set zone adjustment .....85
- Console .....92
- Controls
  - power seat .....106
  - steering column .....75
- Coolant
  - checking and adding .....201
  - coolant temperature light .....8
  - refill capacities .....205, 246
  - specifications .....248–249
- Cruise control (see Speed control) .....77
- Customer Assistance .....170
  
- Ford accessories
  - for your vehicle .....259
  - Ford Extended Service Plan .....252
  - Getting assistance outside the U.S. and Canada .....258
  - Getting roadside assistance ...170
  - Getting the service you need .....252
  - Ordering additional owner's literature .....262
  - The Dispute Settlement Board .....255
  - Utilizing the Mediation/Arbitration Program .....258
  
- D**
- Daytime running lamps (see Lamps) .....27
- Defrost
  - rear window .....42
- Dipstick
  - automatic transmission fluid .....208
  - engine oil .....195
- Doors
  - central unlocking .....92
  - door ajar warning .....13
  - lubricant specifications .....248
- Driving under special conditions
  - through water .....163
  
- E**
- Emergencies, roadside
  - jump-starting .....185
- Emission control system .....232

- Engine .....249–250  
   check engine/  
   service engine soon light .....8  
   cleaning .....242  
   coolant .....201  
   fail-safe coolant .....206  
   idle speed control .....210  
   lubrication  
   specifications .....248–249  
   refill capacities .....246  
   service points .....194–195  
   starting after a collision .....171
- Engine block heater .....142
- Engine fan .....207
- Engine oil .....195  
   checking and adding .....195  
   dipstick .....195  
   filter, specifications .....197, 246  
   recommendations .....197  
   refill capacities .....246  
   specifications .....248–249
- Exhaust fumes .....142
- F**
- Fail safe cooling .....206
- Floor mats .....93
- Fluid capacities .....246
- Foglamps .....28
- Fuel .....225  
   calculating  
   fuel economy .....19, 229  
   cap .....13, 227  
   capacity .....246  
   choosing the right fuel .....227  
   comparisons with EPA fuel  
   economy estimates .....232  
   detergent in fuel .....229
- filling your vehicle  
   with fuel .....225, 227, 229  
   filter, specifications .....229, 246  
   fuel pump shut-off switch .....171  
   gauge .....16  
   improving fuel economy .....229  
   low fuel warning light .....11  
   octane rating .....228, 249–250  
   quality .....228  
   running out of fuel .....229  
   safety information relating to  
   automotive fuels .....225
- Fuses .....172–173
- G**
- Garage door opener .....86
- Gas cap (see Fuel cap) .....13, 227
- Gas mileage  
 (see Fuel economy) .....229
- Gauges .....15  
   engine coolant  
   temperature gauge .....15  
   fuel gauge .....16  
   odometer .....17  
   speedometer .....16  
   tachometer .....16  
   trip odometer .....17
- GAWR  
 (Gross Axle Weight Rating) .....163  
   definition .....163  
   driving with a heavy load .....163  
   location .....163
- GVWR (Gross  
 Vehicle Weight Rating) .....163  
   calculating .....163  
   definition .....163  
   driving with a heavy load .....163  
   location .....163

# Index

## H

- Hazard flashers .....171
- Head restraints .....105
- Headlamps .....27
  - aiming .....237–239
  - autolamp system .....29
  - bulb specifications .....236
  - daytime running lights .....27
  - flash to pass .....28
  - high beam .....10
  - replacing bulbs .....235
  - turning on and off .....27
  - warning chime .....14

Heating .....31

HomeLink universal  
transceiver (see  
Garage door opener) .....86–89

Hood .....193

## I

Ignition .....72, 249–250

- removing the key .....163

Infant seats  
(see Safety seats) .....130–131

Inspection/maintenance  
(I/M) testing .....234

Instrument panel

- cleaning .....243
- cluster .....8, 243
- lighting up
- panel and interior .....29
- location of components .....8

## J

Jack .....181

- positioning .....181

storage .....181

Jump-starting your vehicle .....185

## K

Keyless entry system

- autolock .....97

Keys .....72, 100, 102

- key in ignition chime .....14
- positions of the ignition .....72
- removing from the ignition ....163
- valet key .....72

## L

Lamps

- autolamp system .....29
- bulb replacement
- specifications chart .....236
- cargo lamps .....29
- daytime running light .....27
- fog lamps .....28
- headlamps .....27
- headlamps, flash to pass .....28
- instrument panel, dimming ....29
- interior lamps .....83, 236
- replacing bulbs .....234–236

Lane change indicator  
(see Turn signal) .....73

Lights, warning and indicator .....8

- AdvanceTrac .....12
- air bag .....11
- anti-lock brakes (ABS) .....9, 144
- brake .....10
- bulb warning .....12
- charging system .....10
- check engine .....8
- cruise indicator .....13
- door ajar .....13
- fuel cap light .....13

- high beam .....10, 12
  - low coolant .....8
  - low fuel .....11
  - low washer fluid .....12
  - oil pressure .....11
  - safety belt .....11
  - speed control .....82
  - steering column lock .....12
  - transmission PRNDL
    - indicator .....13
    - turn signal indicator .....10
  - Load limits .....163
    - GAWR .....163
    - GVWR .....163
    - trailer towing .....163
  - Locks
    - autolock .....97
    - childproof .....92
    - doors .....91
  - Lubricant specifications ...248–249
  - Lug nuts, anti-theft .....184
  - Lumbar support, seats .....108
- M**
- Manual transmission .....160
    - fluid capacities .....246
    - lubricant specifications .....249
    - reverse .....162
  - Message center .....17–18
    - select button .....17
    - warning messages .....21
  - Mirrors .....86
    - automatic dimming
      - rearview mirror .....84
      - cleaning .....241
      - heated .....30
      - programmable memory .....98
      - side view mirrors (power) .....29
  - Moon roof .....83
  - Motorcraft parts .....229, 246
- O**
- Octane rating .....228
  - Odometer .....17
  - Oil (see Engine oil) .....195
- P**
- Panic alarm feature, remote
    - entry system .....96
  - Parking brake .....145
  - Parts (see Motorcraft parts) ...246
  - Power distribution box
    - (see Fuses) .....176, 179
  - Power door locks .....91, 97
  - Power steering .....146–147
    - fluid, checking and adding ....208
    - fluid, refill capacity .....246
    - fluid, specifications .....248–249
- R**
- Radio .....42
  - Relays .....172
  - Remote entry system .....93, 96
    - illuminated entry .....96
    - locking/unlocking doors ....94–95
    - opening the trunk .....95
    - panic alarm .....96
    - replacement/additional
      - transmitters .....97
      - replacing the batteries .....96
  - Roof rack .....169

# Index

## S

- Safety belts (see Safety restraints) ....14, 110, 112–115, 117
- Safety defects, reporting .....264
- Safety restraints .....110, 112–117
  - belt minder .....118
  - cleaning the
    - safety belts .....121, 244
  - extension assembly .....121
  - for adults .....112–115
  - for children .....129–130
  - warning light
    - and chime .....11, 14, 117
- Safety seats for children ..130–131
- Seat belts  
(see Safety restraints) .....110
- Seats .....105
  - child safety seats .....130–131
  - cleaning .....244
  - easy access/easyout feature ..108
  - memory seat .....98, 109
- SecuriLock passive anti-theft system .....100, 102
- Select Shift Transmission (SST) shifter .....156
- Servicing your vehicle .....192
- Spark plugs, specifications .....246, 249–250
- Specification chart, lubricants .....248–249
- Speed control .....77
- Speedometer .....16
- Starting your vehicle .....139, 141
  - jump starting .....185

## Steering

- speed sensitive .....147
- Steering column lock .....71
- Steering wheel
  - controls .....75
  - tilting .....12, 74

## T

- Tachometer .....16
- Tires .....181, 219–221
  - changing .....181–182
  - checking the pressure .....221
  - replacing .....223
  - rotating .....222
  - snow tires and chains .....224
  - tire grades .....220
  - treadwear .....220
- Towing .....165
  - recreational towing .....168
  - trailer towing .....165
  - wrecker .....191
- Traction control .....147
  - active light .....12
- Transmission .....13
  - automatic operation .....150
  - fluid, checking and adding (automatic) .....208
  - fluid, checking and adding (manual) .....209
  - fluid, refill capacities .....246
  - lubricant specifications ..248–249
  - manual operation .....13, 160
- Trip odometer .....17
- Trunk .....103
  - remote release .....30, 95
- Turn signal .....10, 14, 73

- V**
- Vehicle dimensions .....250
  - Vehicle Identification Number (VIN) .....251
  - Vehicle loading .....163
  - Ventilating your vehicle .....143
- W**
- Warning chimes .....14
  - Warning lights (see Lights) .....8
  - Water, Driving through .....163
  - Windows
    - power .....90
  - Windshield washer fluid and wipers
    - checking and cleaning .....218
    - operation .....73
    - replacing wiper blades .....218
  - Wrecker towing .....191

## Filling station information

Item	Information
Required fuel	Unleaded premium fuel only - 91 octane
Fuel tank capacity	68.2L (18.0 gallons)
Engine oil capacity-3.0L V6 engine (includes filter change)	6.5L (6.9 quarts). Use Motorcraft SAE 5W-20 Super Premium Motor Oil, Ford specification WSS-M2C153-H.
Engine oil capacity-3.9L V8 engine (includes filter change)	5.7L (6.0 quarts). Use Motorcraft SAE 5W-30 Super Premium Motor Oil, Ford specification WSS-M2C153-G.
Tire size and pressure	Refer to label on right rear passenger door jamb.
Hood release	Pull handle under the instrument panel.
Coolant capacity-3.0L V6 engine <sup>1</sup>	10.6L (11.2 quarts)
Coolant capacity-3.9L V8 engine <sup>1</sup>	11.3L (11.9 quarts)
Power steering fluid capacity	Fill to MAX line on reservoir. Use Motorcraft MERCON® ATF.
Engine cooling fan fluid capacity	Fill to MAX line on reservoir. Use Motorcraft MERCON® ATF.
Manual transmission fluid capacity <sup>2, 3</sup>	1.1L (1.2 quarts). Use Motorcraft MERCON® ATF.
Automatic transmission fluid capacity (5R55N) <sup>2, 4</sup>	11.2L (11.9 quarts). Use Motorcraft MERCON® V ATF.

<sup>1</sup> Use Ford Premium Engine Coolant (green in color). DO NOT USE Ford Extended Life Engine Coolant (orange in color). Refer to *Adding engine coolant, in the Maintenance and Care chapter*.

<sup>2</sup> Ensure the correct automatic transmission fluid is used. MERCON® and MERCON® V are not interchangeable. DO NOT mix MERCON® and MERCON® V. Refer to your scheduled maintenance guide to determine the correct service interval.

<sup>3</sup> Service refill capacity is determined by filling the transmission to the bottom of the filler hole with the vehicle on a level surface.

<sup>4</sup> Approximate dry capacity, includes cooler and tubes. Fluid level should be checked by a qualified service technician.