

Contents

Before driving

Introduction 2

Instrumentation 6

Controls and features 22

Seating and safety restraints 92

Starting and driving

Starting 120

Driving 125

Roadside emergencies 141

Servicing

Maintenance and care 162

Capacities and specifications 209

Customer assistance 214

Reporting safety defects 225

Index 226

All rights reserved. Reproduction by any means, electronic or mechanical including photocopying, recording or by any information storage and retrieval system or translation in whole or part is not permitted without written authorization from Ford Motor Company. Ford may change the contents without notice and without incurring obligation.

Copyright © 1999 Ford Motor Company

Introduction

The following warning may be required by California law:

CALIFORNIA Proposition 65 Warning



Engine exhaust, some of its constituents, and certain vehicle components contain or emit chemicals known to the State of California to cause cancer, or birth defects or other reproductive harm.

ICONS

Indicates a safety alert. Read the following section on *Warnings*.



Indicates vehicle information related to recycling and other environmental concerns will follow.



Correct vehicle usage and the authorized disposal of waste cleaning and lubrication materials are significant steps towards protecting the environment.

Indicates a message regarding child safety restraints. Refer to *Seating and safety restraints* for more information.



Indicates that this Owner Guide contains information on this subject. Please refer to the Index to locate the appropriate section which will provide you more information.



WARNINGS

Warnings provide information which may reduce the risk of personal injury and prevent possible damage to others, your vehicle and its equipment.

BREAKING-IN YOUR VEHICLE

There are no particular breaking-in rules for your vehicle. During the first 1 600 km (1 000 miles) of driving, vary speeds frequently. This is necessary to give the moving parts a chance to break in.

INFORMATION ABOUT THIS GUIDE

The information found in this guide was in effect at the time of printing. Ford may change the contents without notice and without incurring obligation.

Introduction

These are some of the symbols you may see on your vehicle.

Vehicle Symbol Glossary

Safety Alert		See Owner's Guide	
Fasten Safety Belt		Air Bag-Front	
Air Bag-Side		Child Seat	
Child Seat Installation Warning		Child Seat Tether Anchorage	
Brake System		Anti-Lock Brake System	
Brake Fluid - Non-Petroleum Based		Traction Control	
Master Lighting Switch		Hazard Warning Flasher	
Fog Lamps-Front		Fuse Compartment	
Fuel Pump Reset		Windshield Wash/Wipe	
Windshield Defrost/Demist		Rear Window Defrost/Demist	
Power Windows Front/Rear		Power Window Lockout	

Vehicle Symbol Glossary

Child Safety Door Lock/Unlock		Interior Luggage Compartment Release Symbol	
Panic Alarm		Engine Oil	
Engine Coolant		Engine Coolant Temperature	
Do Not Open When Hot		Battery	
Avoid Smoking, Flames, or Sparks		Battery Acid	
Explosive Gas		Fan Warning	
Power Steering Fluid		Maintain Correct Fluid Level	
Emission System		Engine Air Filter	
Passenger Compartment Air Filter		Jack	

Instrumentation

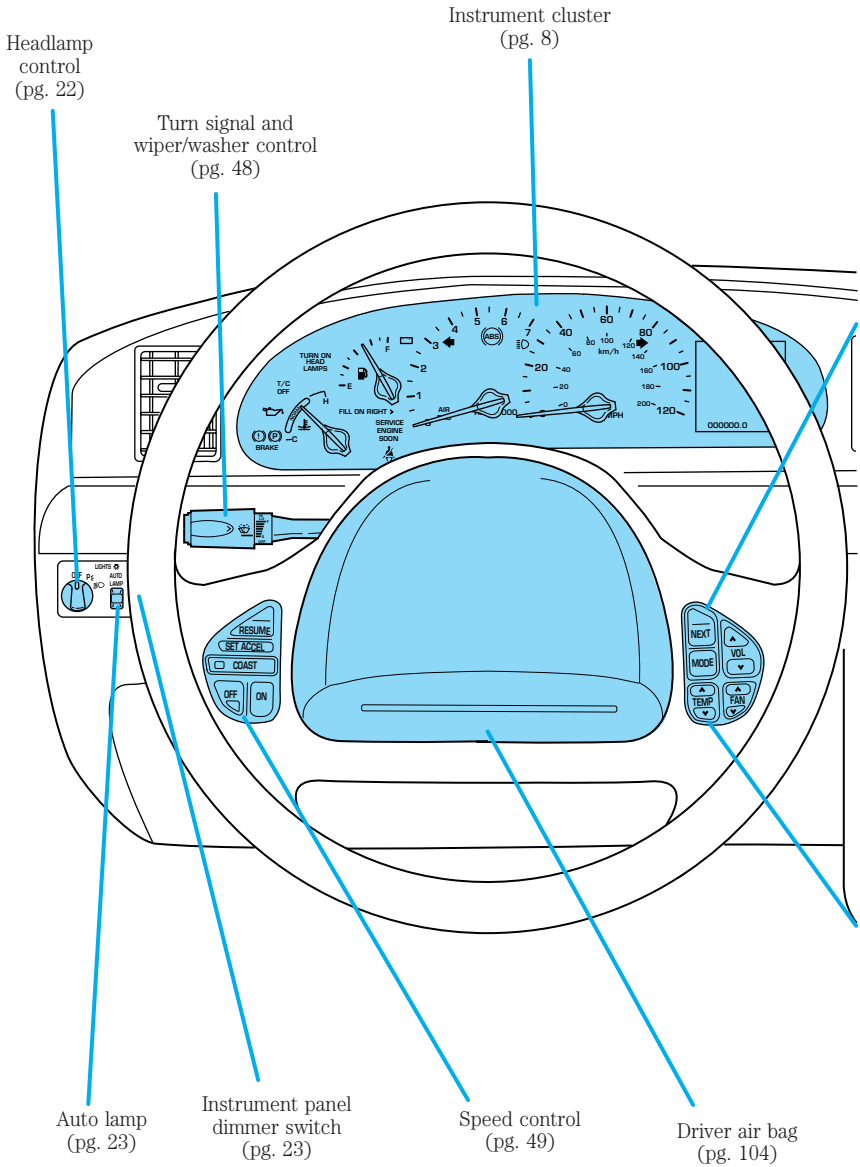

Instrumentation

Electronic sound system controls*
(pg. 48)

Message Center
(pg. 14)

Clock
(pg. 30)

Electronic sound system
(pg. 30)

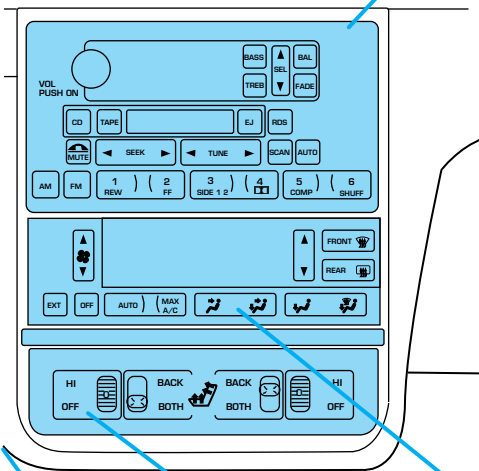
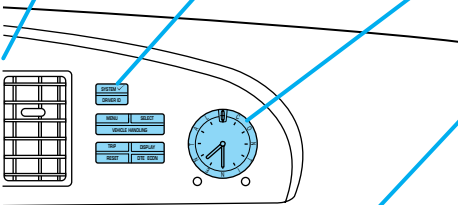

Climate controls
(pg. 48)

Heated seat control
(pg. 94)

Climate control system
(pg. 24)

* if equipped

Instrumentation

WARNING LIGHTS AND CHIMES

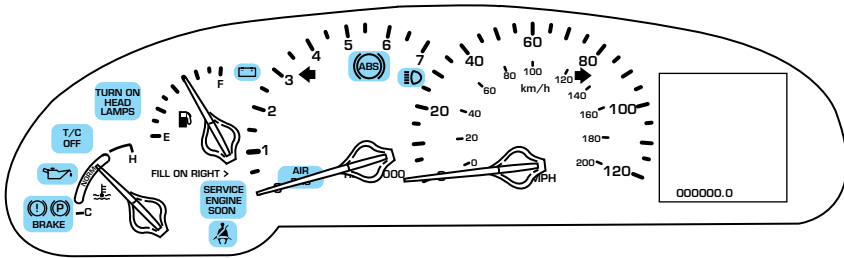

Service engine soon

Your vehicle is equipped with a computer that monitors the engine's emission control system. This system is commonly known as the On Board Diagnostics System (OBD II). The OBD II system protects the environment by ensuring that your vehicle continues to meet government emission standards. The OBD II system also assists the service technician in properly servicing your vehicle.

**SERVICE
ENGINE
SOON**

The *Service Engine Soon* indicator light illuminates when the ignition is first turned to the ON position to check the bulb. If it comes on after the engine is started, one of the engine's emission control systems may be malfunctioning. The light may illuminate without a driveability concern being noted. The vehicle will usually be drivable and will not require towing.

What you should do if the *Service Engine Soon* light illuminates Light turns on solid:

This means that the OBD II system has detected a malfunction.

Temporary malfunctions may cause your *Service Engine Soon* light to illuminate. Examples are:

1. The vehicle has run out of fuel. (The engine may misfire or run poorly.)
2. Poor fuel quality or water in the fuel.
3. The fuel cap may not have been properly installed and securely tightened.

Instrumentation

These temporary malfunctions can be corrected by filling the fuel tank with high quality fuel of the recommended octane and/or properly installing and securely tightening the gas cap. After three driving cycles without these or any other temporary malfunctions present, the *Service Engine Soon* light should turn off. (A driving cycle consists of a cold engine startup followed by mixed city/highway driving.) No additional vehicle service is required.

If the *Service Engine Soon* light remains on, have your vehicle serviced at the first available opportunity.

Light is blinking:

Engine misfire is occurring which could damage your catalytic converter. You should drive in a moderate fashion (avoid heavy acceleration and deceleration) and have your vehicle serviced at the first available opportunity.



Under engine misfire conditions, excessive exhaust temperatures could damage the catalytic converter, the fuel system, interior floor coverings or other vehicle components, possibly causing a fire.

Air bag readiness

Momentarily illuminates when the ignition is turned ON. If the light fails to illuminate, continues to flash or remains on, have the system serviced immediately.

**AIR
BAG**

Safety belt

Momentarily illuminates when the ignition is turned to the ON position to remind you to fasten your safety belts. For more information, refer to the *Seating and safety restraints* chapter.



Instrumentation

Brake system warning

Momentarily illuminates when the ignition is turned to the ON position. Also illuminates if the parking brake is engaged. If the brake warning lamp does not illuminate at these times, seek service immediately. Illumination after releasing the parking brake indicates low brake fluid level and the brake system should be inspected immediately.

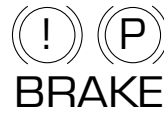

Anti-lock brake system (ABS)

Momentarily illuminates when the ignition is turned to the ON position. If the light remains on, continues to flash or fails to illuminate, have the system serviced immediately. With the ABS light on, the anti-lock brake system is disabled and normal braking is still effective unless the brake warning light also remains illuminated with the parking brake released.

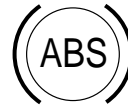

Turn signal

Illuminates when the left or right turn signal or the hazard lights are turned on. If one or both of the indicators stay on continuously or flash faster, check for a burned-out turn signal bulb. Refer to *Exterior bulbs* in the *Maintenance and care* chapter.

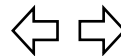

High beams

Illuminates when the high beam headlamps are turned on.



Turn on headlamps (if equipped)

Illuminates to remind the driver to turn the headlamps on when:

- the daytime running lamps are on (if equipped)
- the autolamps are off
- the autolamp sensor determines it is night time

**TURN ON
HEAD
LAMPS**

Charging system

Illuminates when the ignition is turned to the ON position and the engine is off. The light also illuminates when the battery is not charging properly, requiring electrical system service.

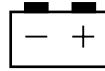

Engine oil pressure

Momentarily illuminates when the ignition is turned to the ON position and the engine is off. Illuminates when the oil pressure falls below the normal range. Stop the vehicle as soon as safely possible and switch off the engine immediately. Check the oil level and add oil if needed. Refer to *Engine oil* in the *Maintenance and care* chapter.

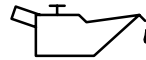

Traction Control™ off light

Illuminates when the Traction Control™ system has been disabled (by the driver or as a result of a system failure). For more information, refer to the *Driving* chapter.

**T/C
OFF**

Safety belt warning chime

Sounds to remind you to fasten your safety belts.

For information on the safety belt warning chime, refer to the *Seating and safety restraints* chapter.

Instrumentation

Supplemental restraint system (SRS) warning chime

For information on the SRS warning chime, refer to the *Seating and safety restraints* chapter.

Key-in-ignition warning chime

Sounds when the key is left in the ignition in the OFF/LOCK or ACC position and the driver's door is opened.

Headlamps on warning chime

Sounds when the headlamps or parking lamps are on, the ignition is off (and the key is not in the ignition) and the driver's door is opened.

GAUGES

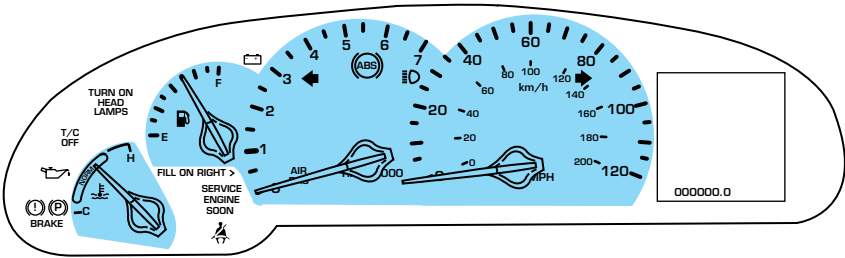

Fuel gauge

Displays approximately how much fuel is in the fuel tank (when the key is in the ON position). The fuel gauge may vary slightly when the vehicle is in motion. The ignition should be in the OFF position while the vehicle is being refueled. When the gauge first indicates empty, there is a small amount of reserve fuel in the tank. When refueling the vehicle from an empty indication, the amount of fuel that can be added will be less than the advertised capacity due to the reserve fuel.

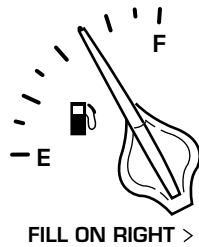

Instrumentation

Speedometer

Indicates the current vehicle speed.

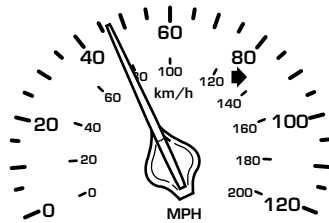

Odometer

The odometer is located in the message center. It registers the total kilometers (miles) of the vehicle. Pressing the E/M control (if equipped) will alternate between English (miles) and Metric (kilometers) measurements.

Tachometer

Indicates the engine speed in revolutions per minute.

Driving with your tachometer pointer in the red zone may damage the engine.

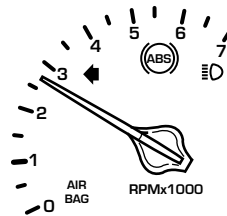

Engine coolant temperature gauge

Indicates the temperature of the engine coolant. At normal operating temperature, the needle remains within the normal area (the area between the "H" and "C"). If it enters the red section, the engine is overheating. Stop the vehicle as soon as safely possible, switch off the engine immediately and let the engine cool. Refer to *Engine coolant* in the *Maintenance and care* chapter.

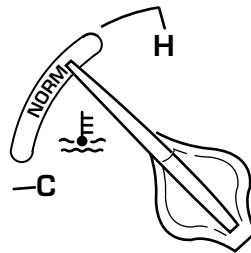

Never remove the coolant reservoir cap while the engine is running or hot.

Instrumentation

This gauge indicates the temperature of the engine coolant, not the coolant level. If the coolant is not at its proper level the gauge indication will not be accurate.

ELECTRONIC MESSAGE CENTER

The electronic message center only works when the ignition is in the ON position.

The message center tells you about the condition of your vehicle by two methods:

- operator selectable features
- continuous warning reporting of monitored systems

You can select different features for the message center to display by using the message center controls located to the right of the instrument cluster.

You will hear a tone when you press one of these controls.

However, the message center will display the appropriate warning message if it detects a warning from any of the monitored systems.

If you have a vehicle with the Driver Select System, which allows you to save operator selectable features to DRIVER 1 or DRIVER 2, you have a DRIVER ID control in place of the E/M control.

The message center will display the **Memory Profile System** features (operator selectable features) which are selected from the MENU and VEHICLE HANDLING controls.

The Memory Profile System allows for two primary drivers to save their individual seat and outside rearview mirror position preferences. The feature will then be set to the remote entry transmitter, that will automatically recall the saved individualized preferences. Refer to *Basic Operation of Memory Profile System* in this section.

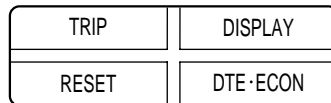
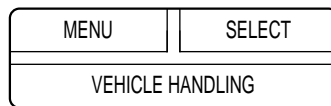
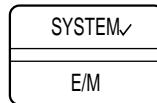

Basic operation of Memory Profile System

In order for the system to be able to store or recall an individual's seat and mirror position preferences, the Memory Profile must first recognize who will be driving the vehicle. Drivers may identify themselves to the system one of two ways:

- Pressing the unlock control on the appropriate remote transmitter (Memory position 1 or Memory position 2 is identified by the number on the back of the remote transmitter) before opening the driver's door.
- Entering either the Personality 1 or Personality 2 personalized code into the keyless entry keypad before opening the driver's door.

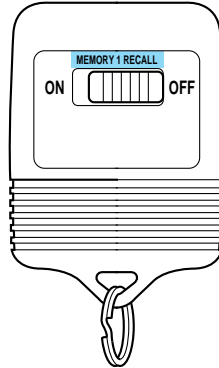

For information on programming personalized codes see *Remote and Keyless entry systems* in the *Control and features* section.

Once the system has identified the driver (Memory position 1 or Memory position 2), the seat and mirror will automatically begin to move to that driver profile. Changes made to the seat and mirror positions will automatically be saved to that profile.

If the driver should enter the vehicle without first identifying themselves, all features will remain at their last setting or position and any settings will be saved to the vehicle not individualized settings.

Instrumentation

If Memory position 1 or Memory position 2 wishes to make temporary changes to their seat or outside mirror positions without affecting their preferred positions they may do so by:

- Using the switch on the back of the remote transmitter to turn the Memory Profile System OFF prior to pressing the unlock control on the remote transmitter or unlocking the vehicle with the key.
- Entering the vehicle without identifying themselves using the two methods listed above.
- Turning the DRIVER ID (if equipped in the message center) OFF to allow for temporary setting changes.

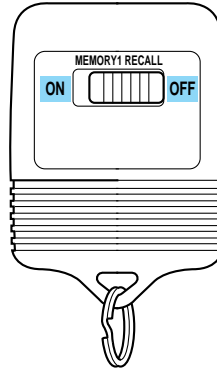

This option may be useful to temporarily reposition the driver's seat and mirrors during an extended drive.

Operator selectable features

System check

Pressing this control causes the message center to cycle through the status of each of the systems being monitored. For each of these systems, the message center will indicate either an OK message or a warning message for three seconds.



The sequence of the system check report is:

- voltage level
- engine temp
- oil level
- coolant level
- washer fluid
- doors (driver and passenger side). This message can only be reset by closing the door(s). If the RESET control is pressed, PLEASE CLOSE DOOR will be displayed.
- trunk closed
- exterior lamps (front turn, brake and tail)

- fuel level
- distance to empty
- traction control
- ride control

System warnings

System warnings alert you to possible problems or malfunctions in your vehicle's operating systems.

The message center will display the last selected feature if there are no more warning messages. This allows you to use the full functionality of the message center after you acknowledge the warning by pressing the RESET control and clearing the warning message.



Door Ajar	Cannot be reset
Driver's Door Ajar	
Check Engine Temp	Warning returns after 10 minutes
Transmission Overheat	
Check Transmission	
Low Oil Level	
Check Charging System	
Low Fuel Level	
Low Engine Coolant	
Low Tire Pressure (if equipped)	

Instrumentation

Gear Display Data ERR	Warning reappears after key is turned from OFF to ON
Brake Lamp Out	
Check Traction Control	
Check Ride Control	
Trunk Ajar	
Check Steering Assist	
Low Washer Fluid	
Air Leveling Disabled	
Tail Lamp Out	
Check FRT Turn Lamps	
Turn on Headlamps	

Warning messages that have been reset are divided into two categories:

- They will reappear on the display ten minutes from the reset.
- They will not reappear until an ignition OFF-ON cycle has been completed. This acts as a reminder that these warning conditions still exist within the vehicle.

E/M (if equipped)

Press this control to switch the odometer and display readouts from metric (kilometers) to English (miles) units.

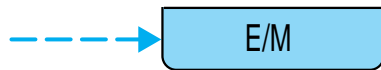

DRIVER ID (if equipped)

Press this control and use SELECT to choose DRIVER 1 or DRIVER 2 when choosing operator selectable features. Seat and mirror positions and nine operator selectable features, found under the MENU and VEHICLE HANDLING controls, will be saved to DRIVER 1 or DRIVER 2. These will be automatically recalled when the drivers identify themselves to the system with the remote entry transmitter (refer to *Basic Operation of Memory Profile System* in this section) or selecting DRIVER 1 or DRIVER 2 in the message center. When a vehicle setting is changed, the message center will display “SAVED TO DRIVER 1 or DRIVER 2” for 5 seconds to confirm the change has been made. Press the SELECT to choose “OFF” for temporary position/setting changes which will not be stored.



MENU

Press this control to change various convenience settings throughout the vehicle. Each press of the MENU control will display the following:

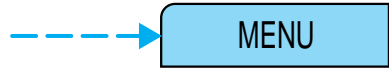

- Traction control (returns to “ON” everytime vehicle is started).
- Express window (completely goes down with one touch on the power switch).
- Auto lock (locks the doors when the vehicle reaches 5 km/h [3 mph]).
- Horn chirp (sounds horn one time whenever the doors are locked using the remote transmitter).
- Seat access (moves seat back to aid entry/exit from the vehicle).
- Reverse mirrors (tilts the exterior mirrors downward to assist parking using reverse).
- English/metric (changes the odometer and display readouts)

Press the SELECT control to change the settings to ON or OFF.

These settings will be saved to the vehicle not individualized settings.

Vehicles equipped with the DRIVER ID control, the settings will be saved to DRIVER 1 or DRIVER 2.

SELECT

Press the SELECT control to change settings in MENU or VEHICLE HANDLING modes.



VEHICLE HANDLING

Press this control to adjust the STEERING EFFORT SETTINGS between NORMAL, LOW and HIGH.

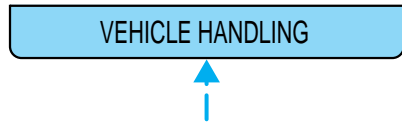

Vehicles equipped with the DRIVER ID control, press this control once to adjust RIDE CONTROL SETTINGS between NORMAL, PLUSH and FIRM.

Press this control a second time to adjust the STEERING EFFORT SETTINGS between NORMAL, LOW and HIGH. The combination of firm ride control and low steering effort cannot be selected.

Press the SELECT control to change settings.

Instrumentation

TRIP

Press this control to display the first of two trip odometers. Press it again to display the second trip odometer.

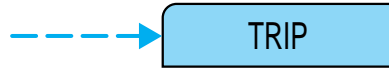

To reset the displayed trip odometer, press the RESET control.

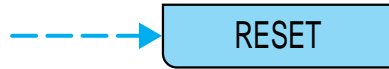

DISPLAY

Press this control to turn the message center display off. Press it again to turn the display on. Warnings override an off display and must be reset for the display to be off again.



RESET

Press this control to reset:

- warnings
- average fuel economy
- trip odometers



The other selectable features are unaffected by pressing RESET.

DTE/ECON

- Press the DTE/ECON control once to display approximately how far you can drive before running out of fuel, or the distance to empty (DTE). To ensure accuracy, turn the ignition OFF when you fill the tank.
- Press the DTE/ECON control a second time to display the average fuel economy in liters/100 kilometers or miles/gallon, based on distance traveled and rate of fuel used information.
- To reset this feature, press the RESET control while average fuel economy is displayed (while you are driving).



Instrumentation

The DTE function will flash for 5 seconds and sound a tone for 1 second when you have approximately:

- 40 km (25 miles)
- 16 km (10 miles)

DTE is calculated using a running average fuel economy initialized by the factory. This value is not the same as the average fuel economy display. The running average fuel economy is based on more than 800 kilometers (500 miles) of driving history, and is reinitialized if the battery is disconnected.

If the FUEL LEVEL ERROR message is displayed, there is a problem with the fuel indication system and you should contact your dealer for service as soon as possible.

Checking your highway fuel economy using the electronic message center display

The following procedure will allow you to accurately monitor your actual highway fuel economy. Since this procedure requires the vehicle speed control system to be set to highway speeds, it must be run only on suitable roadways where long distance speed control can be safely maintained.

You may notice gradual improvement in fuel economy over the course of your vehicle's break-in period (approximately 1 600 kilometers [1 000 miles]).

1. Set the speed control. Refer to *Speed control* in the *Controls and features* chapter.

2. Press the Distance to Empty (DTE) Economy (ECON) control until "Average Miles per Gallon" is displayed.



3. Press the RESET control to clear the DTE/ECON system memory.



- *Actual highway fuel economy is now displayed.* This current average measure will change as the speed control system changes the engine speed to maintain a constant vehicle speed. This is most noticeable in hilly environments.

It is important to press the RESET control after setting the speed control to get accurate highway fuel economy readings.

Controls and features

HEADLAMP CONTROL

Rotate the headlamp control to the first position to turn on the parking lamps only. Rotate to the second position to also turn on the headlamps.

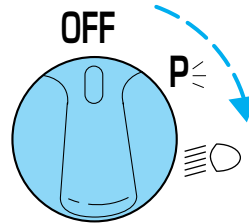

The exterior lamps will illuminate when the ignition is ON and the windshield wiper control is in the interval, LO or HI position.

The instrument panel lighting will dim noticeably approximately 15 seconds after the wipers are turned on. The lights will remain in this state until 30 seconds after the wipers are turned off.

Daytime running lamps (DRL) (if equipped)

Turns the headlamps on with a reduced output. To activate:

- the ignition must be in the ON position and
- the headlamp control is in the OFF or Parking lamps position.



Always remember to turn on your headlamps at dusk or during inclement weather. The Daytime Running Light (DRL) System does not activate your tail lamps and generally may not provide adequate lighting during these conditions. Failure to activate your headlamps under these conditions may result in a collision.

High beams

Push forward to activate.

Pull toward you to deactivate.

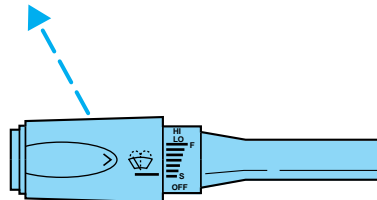

Controls and features

Flash to pass

Pull toward you to activate and release to deactivate.

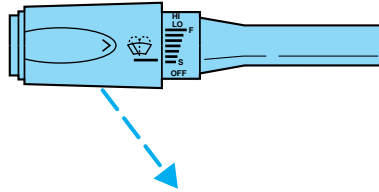

PANEL DIMMER CONTROL

Use to adjust the brightness of the instrument panel during headlight and parklamp operation.

- Push up to brighten.
- Push down to dim.

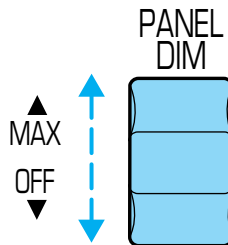

AUTOLAMP CONTROL

The autolamp system provides light sensitive automatic on-off control of the exterior lights normally controlled by the headlamp control.

The autolamp system also keeps the lights on for a preselected period of time after the ignition switch is turned to OFF.

- To turn autolamps on, push the control up toward the MAX position. As you press this switch, the autolamp system's status will be displayed in the message center. The system can be set to provide light for up to three minutes after you turn the ignition OFF.
- To turn autolamps off, push the control down toward OFF.

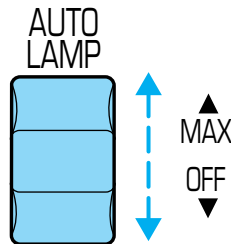

Controls and features

CLIMATE CONTROL SYSTEM

Electronic Automatic Temperature Control (EATC) system

The EATC system will maintain a selected temperature and automatically control airflow. You can override automatic operation with any of the override controls, the fan speed control or the steering wheel controls (if equipped).

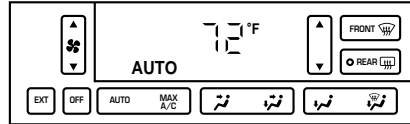

Turning the EATC on

Press AUTO, any of the override controls or the fan speed control. The EATC will only operate when the vehicle is running.

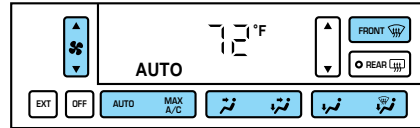

Turning the EATC off

Press OFF. The Outside Temperature (EXT) function will continue to operate until the ignition is turned off.

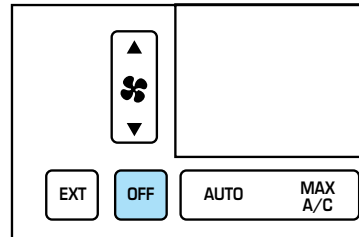

Automatic operation

Press AUTO and select the desired temperature. The selected temperature and the word AUTO will appear in the display window. The EATC system will either heat or cool to achieve the selected temperature. The system will automatically determine fan speed, airflow location and if outside air or recirculated air is required. Fan speed remains automatic unless the fan speed control is pressed or the steering wheel controls (if equipped) are pressed.

When in AUTO and weather conditions require heat, air will be sent to the floor. However, if the engine is not warm enough to provide heat, the fan will not operate. In 3½ minutes or less, the fan speed will start to increase and the airflow location will change to the floor area.

Controls and features

If unusual conditions exist (i.e.-window fogging, etc.), the manual override controls allow you to select airflow locations and the fan control allows you to adjust fan speed as necessary.

Temperature selection

The display window indicates the selected temperature, function (AUTO or one of the override controls) and manual control of fan speed () if automatic fan speed is not desired.

To control the temperature, select any temperature between 18°C (65°F) and 29°C (85°F) by pressing the temperature control.

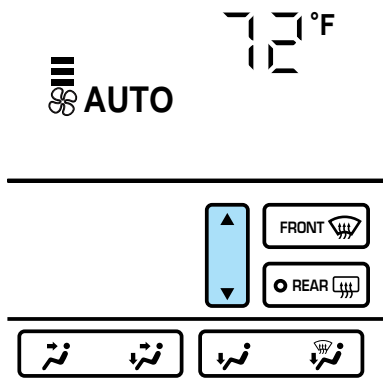

For continuous maximum cooling, push the temperature control until 16°C (60°F) is shown in the display window. The EATC will continue maximum cooling (disregarding the displayed temperature) until a warmer temperature is selected by pressing the temperature control.

For continuous maximum heating, push the temperature control until 32°C (90°F) is shown in the display window. The EATC will continue maximum heating (disregarding the displayed temperature) until a cooler temperature is selected by pressing the temperature control.

Temperature conversion

Press MAX A/C and FRONT  at the same time (for one second) to switch between Fahrenheit and Celsius.

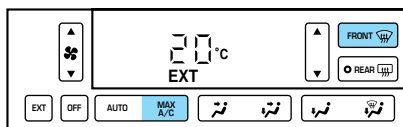

Your vehicle has an English/Metric (E/M) control to change your electronic message center display from English to Metric. This control will also change the temperature display. Refer to *Electronic Message Center* in the *Instrumentation* chapter.

Controls and features

Fan speed ()

When AUTO is pressed, fan speed is adjusted automatically for existing conditions. You can override fan speed at any time. To control fan speed manually, press the fan control or the steering wheel fan speed control to cancel automatic fan speed operation. Press the control up for higher fan speed or down for lower fan speed. Press the steering wheel control up for higher fan speed or down for lower fan speed.

The display will show  and a bar graph to indicate manual fan operation and relative speed.

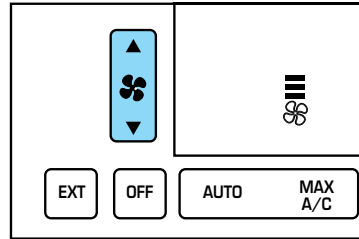



To return to automatic fan operation, press AUTO.

Manual override controls

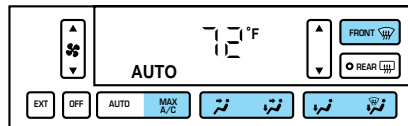
The override controls allow you to determine where airflow is directed. To return to full automatic control, press AUTO.







The air conditioning compressor can operate in all modes except  and . It will also operate only when required when AUTO has been selected. However, the air conditioning will only function if the outside temperature is about 10°C (50°F) or higher.

Since the air conditioner removes considerable moisture from the air during operation, it is normal if clear water drips on the ground under the air conditioner drain while the system is working and even after you have stopped the vehicle.

Under normal conditions, your vehicle's climate control system should be left in any position other than MAX A/C or OFF when the vehicle is parked. This allows the vehicle to “breathe” through the outside air inlet duct.

Controls and features

- MAX A/C-Uses recirculated air to cool the vehicle. The temperature will display 16°C (60°F). To exit, press AUTOMATIC or any other override controls. MAX A/C is noisier than normal A/C but more economical and will cool the inside of the vehicle faster. Airflow is from the instrument panel registers. This mode can also be used to prevent undesirable odors from entering the vehicle.
-  -Distributes outside air through the instrument panel registers. However, the air cannot be cooled below the outside temperature because the air conditioning does not operate in this mode.
-  -Distributes outside air through the instrument panel registers and the floor ducts. Heating and air conditioning capabilities are provided in this mode. The air will be heated or cooled based on the temperature selection. For added customer comfort, the air distributed through the floor ducts will be slightly warmer than the air sent to the instrument panel registers.
-  -Allows for maximum heating by distributing outside air through the floor ducts. However, the air cannot be cooled below the outside temperature because the air conditioning does not operate in this mode.
-  -Distributes outside air through the windshield defroster ducts and the floor ducts. Heating and air conditioning capabilities are provided in this mode. The air will be heated or cooled based on the temperature selection. For added customer comfort, the air distributed through the floor ducts will be slightly warmer than the air sent to the windshield defroster ducts. If the temperature is about 10°C (50°F) or higher, the air conditioner will automatically dehumidify the air to reduce fogging.
- FRONT  -Distributes outside air through the windshield defroster ducts. It can be used to clear ice or fog from the windshield. If the outside air temperature is about 10°C (50°F) or higher, the air conditioner will automatically dehumidify the air to reduce fogging.
- OFF-Outside air is shut out and the fan will not operate. For short periods of time only, use this mode to reduce undesirable odors from entering the vehicle.

Controls and features

Displaying outside temperature

Press EXT to display the outside air temperature. It will be displayed until EXT is pressed again.

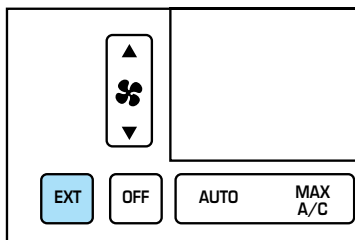

If the selected temperature is changed while the outside temperature is displayed, the new temperature will be displayed for four seconds after it is changed, then the outside temperature will return to the window.

If a manual override function is selected while the outside temperature is displayed, the new function will be displayed for four seconds after it is changed, then the outside temperature will return to the window along with the override selection.

The outside temperature reading is most accurate when the vehicle is moving. Higher readings may be obtained when the vehicle is not moving. The readings that you get may not agree with temperatures given on the radio due to differences in vehicle and station locations.

Operating tips

- In humid weather, select the FRONT  control before driving. This will reduce fogging on your windshield. After a few minutes, select any desired position.
- To prevent humidity buildup inside the vehicle, don't drive with the climate control system in the OFF position.
- Don't put objects under the front seat that will interfere with the airflow to the back seats.
- Remove any snow, ice or leaves from the air intake area (at the bottom of the windshield).

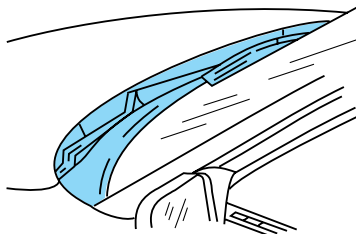

Controls and features

- If your vehicle has been parked with the windows closed during hot weather, the air conditioner will do a much faster job of cooling if you drive for two or three minutes with the windows open. This will force most of the hot, stale air out of the vehicle. Then operate the air conditioner as you would normally.
- If the air conditioner works well in MAX A/C but not in normal A/C, this may indicate that the cabin air filter (if equipped) needs to be replaced.
- When placing objects on top of your instrument panel, be careful to not place them over the defroster outlets. These objects can block airflow and reduce your ability to see through your windshield. Also, avoid placing small objects on top of your instrument panel. These objects can fall down into the defroster outlets and block airflow and possibly damage your climate control system.



Do not place objects on top of the instrument panel, as these objects may become projectiles in a collision or sudden stop.

REAR WINDOW DEFROSTER

The rear defroster control is located on the instrument panel.

Press the rear defroster control to clear the rear window of thin ice and fog.

- A small LED will illuminate when the rear defroster is activated.

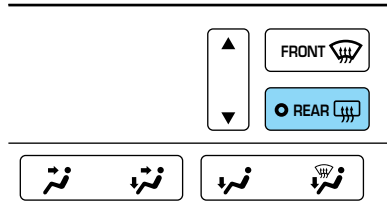

The ignition must be in the ON position to operate the rear window defroster.

The defroster turns off automatically after 10 minutes or when the ignition is turned to the OFF position. To manually turn off the defroster before 10 minutes have passed, push the control again.

Controls and features

CLOCK

Press to increase the time displayed.

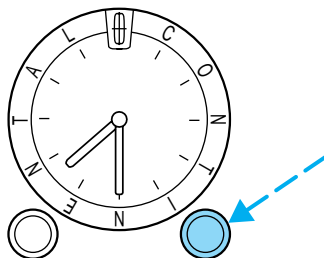

Press to decrease the time displayed.

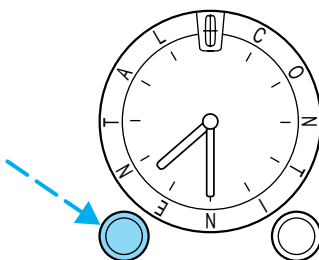

USING YOUR AUDIO SYSTEM

Your audio system is equipped with selective lighting, a unique lighting strategy. This lighting feature is operable when the headlamps are illuminated. During the operation of any selected mode, lighting for the individual function controls will either illuminate or turn off. Those controls which have a function for the specific mode of operation selected will be lit, while the controls which have no function for that mode will be turned off.

Controls and features

High Level Audio System with AM/FM Stereo/Cassette (Radio Controlled CD Changer Compatible)

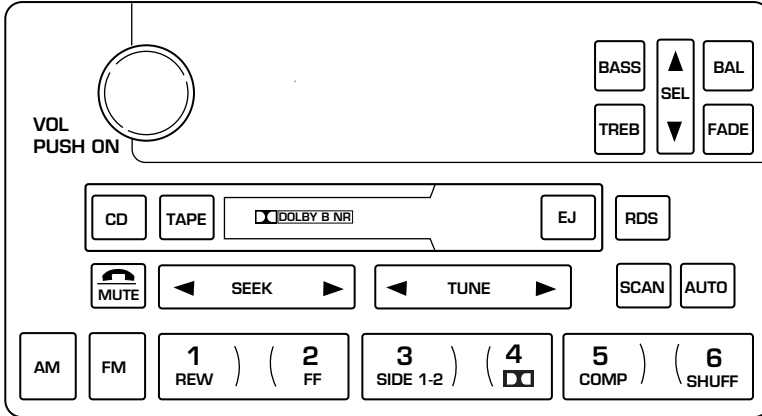

Premium AM/FM Stereo/Cassette/Alpine Audio System (Radio Controlled CD Changer Compatible)

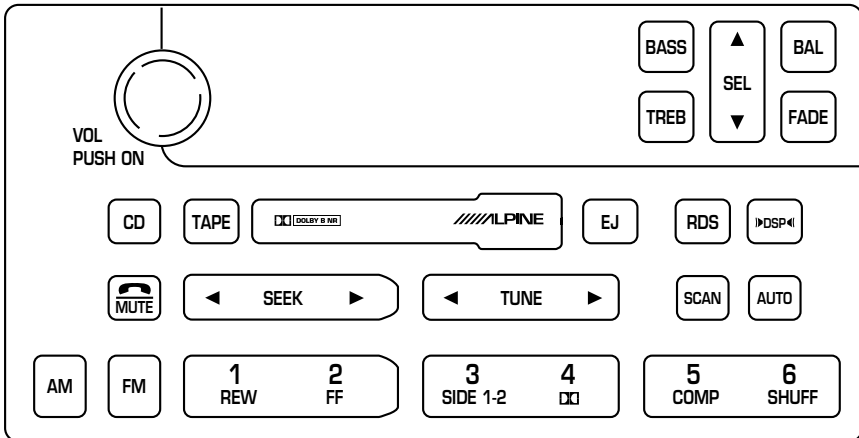

Your vehicle is equipped with a delayed accessory feature. This feature enables the audio playing media to continue playing up to 10 minutes after the ignition has been turned off, or until a door is opened.

Controls and features

Volume/power control

Press the control to turn the audio system on or off.

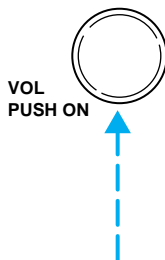

Turn the control to raise or lower volume.

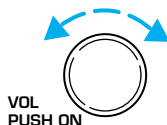

If the volume is set above a certain level and the ignition is turned off, the volume will come back on at a “nominal” listening level when the ignition switch is turned back on.

Speed sensitive volume

With this feature, radio volume changes automatically and slightly with vehicle speed to compensate for road and wind noise.

The recommended level for speed sensitive volume is from level 1 through level 3. Level 0 turns the speed sensitive volume off and level 7 is the maximum setting.

With the radio on, press and hold the volume control for five seconds, then press:

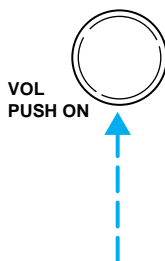

Controls and features

- ▲ to increase volume compensation
- ▼ to decrease or shut off the volume compensation

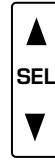

AM/FM select

The AM/FM select control works in radio, tape and CD modes (if equipped).



AM/FM select in radio mode

This control allows you to select AM or FM frequency bands. Press the control to switch between AM, FM1 or FM2 memory preset stations.

AM/FM select in tape mode

Press this control to stop tape play and begin radio play.

AM/FM select in CD mode (if equipped)

Press this control to stop CD play and begin radio play.

Tune adjust

The tune control works in radio or CD mode (if equipped).

Tune adjust in radio mode

- Press ◀ to move to the next frequency down the band (whether or not a listenable station is located there). Hold the control to move through the frequencies quickly.
- Press ▶ to move to the next frequency up the band (whether or not a listenable station is located there). Hold for quick movement.



Tune adjust for CD changer (if equipped)

- Press ◀ to select the previous disc in the CD changer. (Play will begin on the first track of the disc unless the CD changer is in shuffle mode.) Refer to *Shuffle feature* for more information. Hold the control to continue reversing through the disc.





Controls and features

- Press  to select the next disc in the CD changer. Hold the control to fast-forward through the remaining discs.

Seek function



The seek function control works in radio, tape or CD mode (if equipped).

Seek function in radio mode



- Press  to find the next listenable station down the frequency band.
- Press  to find the next listenable station up the frequency band.



Seek function in tape mode

- Press  to listen to the previous selection on the tape or return to the beginning of the current selection.
- Press  to listen to the next selection on the tape.

Seek function for CD changer (if equipped)

- Press  to seek to the previous track of the current disc. If a selection has been playing for three seconds or more and you press , the CD changer will replay that selection from the beginning.
- Press  to seek forward to the next track of the current disc. After the last track has been completed, the first track of the current disc will automatically replay.



Scan function

The scan function works in radio, tape or CD mode (if equipped).



Scan function in radio mode

Press the SCAN control to hear a brief sampling of all listenable stations on the frequency band. Press the SCAN control again to stop the scan mode.

Controls and features

Scan function in tape mode

Press the SCAN control to hear a short sampling of all selections on the tape. (The tape scans in a forward direction. At the end of the tape's first side, direction automatically reverses to the opposite side of the tape.) To stop on a particular selection, press the control again.

Scan function in CD mode (if equipped)

Press the SCAN control to hear a short sampling of all selections on the CD. (The CD scans in a forward direction, wrapping back to the first track at the end of the CD.) To stop on a particular selection, press the control again.

Radio station memory preset

The radio is equipped with four or six station memory preset controls. These controls can be used to select up to four or six preset AM stations and eight or twelve FM stations (four to six in FM1 and four to six in FM2).

Setting memory preset stations

1. Select the frequency band with the AM/FM select control.
2. Select a station. Refer to *Tune adjust* or *Seek function* for more information on selecting a station.
3. Press and hold a memory preset control until the sound returns, indicating the station is held in memory on the control you selected.

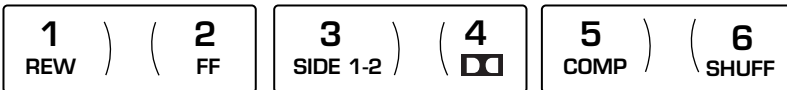

Autoset memory preset

Autoset allows you to set strong radio stations without losing your original manually set preset stations. This feature is helpful on trips when you travel between cities with different radio stations.

Starting autoset memory preset

1. Select a frequency using the AM/FM select controls.
2. Press the control.



Controls and features

3. When the first six strong stations are filled, the station stored in memory preset control 1 will start playing.

If there are less than six strong stations available on the frequency band, the remaining memory preset controls will all store the last strong station available.

To deactivate autoselect and return to your audio system's manually set memory stations, press the control again.

Bass adjust

The bass adjust control allows you to increase or decrease the audio system's bass output.

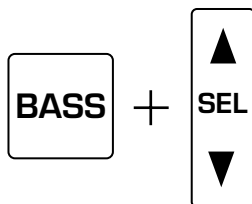

Treble adjust

The treble adjust control allows you to increase or decrease the audio system's treble output.

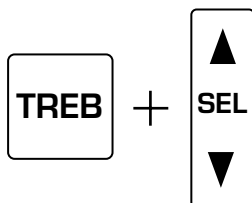

Speaker balance adjust

Speaker sound distribution can be adjusted between the right and left speakers.

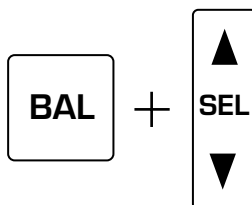

Controls and features

Speaker fade adjust

Speaker sound can be adjusted between the front and rear speakers.

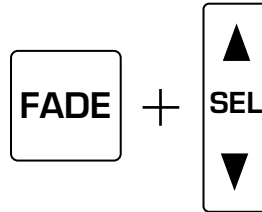

Tape/CD select (if equipped)

- To begin tape play (with a tape loaded into the audio system) while in the radio or CD mode, press the TAPE control. Press the button during rewind or fast forward to stop the rewind or fast forward function.
- To begin CD play (if CD[s] are loaded), press the CD control. The first track of the disc will begin playing. After that, CD play will begin where it stopped last.



Rewind

The rewind control works in tape and CD modes (if equipped).

- In tape mode, radio play will continue until rewind is stopped (with the TAPE control) or the beginning of the tape is reached.



Controls and features

- In CD mode, pressing the REW control for less than three seconds results in slow rewind. Pressing the control for more than three seconds results in fast rewind.

Fast forward

The fast forward control works in tape and CD modes (if equipped).

- In the tape mode, tape direction will automatically reverse when the end of the tape is reached.
- In CD mode, pressing the control for less than three seconds results in slow forward action. Pressing the control for more than three seconds results in fast forward action.

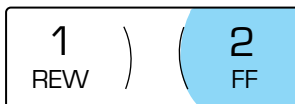

Tape direction select

Press SIDE 1-2 to play the alternate side of a tape.

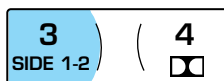

Eject function

Press the control to stop and eject a tape.



Dolby® noise reduction

Dolby® noise reduction operates only in tape mode. Dolby® noise reduction reduces the amount of hiss and static during tape playback.

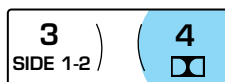

Press the  control to activate (and deactivate) Dolby® noise reduction.

Dolby® noise reduction is manufactured under license from Dolby® Laboratories Licensing Corporation. “Dolby®” and the double-D symbol are trademarks of Dolby® Laboratories Licensing Corporation.

Controls and features

Compression feature

Compression adjust brings soft and loud CD passages together for a more consistent listening level.

Press the COMP control to activate and deactivate compression adjust.

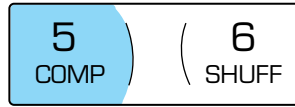

Shuffle feature

The shuffle feature operates in CD mode and plays all tracks on the current disc in random order. If equipped with the CD changer, the shuffle feature continues to the next disc after all tracks are played.

Press the SHUFFLE control to start this feature. Random order play will continue until the SHUFFLE control is pressed again.



Setting the clock

Your vehicle is equipped with a separate instrument panel mounted clock. Please refer to *Clock* in this chapter for instructions on setting the clock.

Radio data system (RDS) feature

When selected, the RDS (Radio Data System) function performs the following:

- Displays the radio station call letters
- Displays the type of music format (jazz, country, rock)
- Searches for a particular type of music format by selecting the SEEK control
- Allows traffic information broadcasts to be turned on and off with the SEL control



Press the RDS control. Use the SEL control to select ON or OFF to enable or disable the feature.

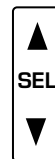

Controls and features

Traffic

- Press the RDS control until TRAFFIC is displayed.



- Use the SEL control to select ON or OFF. With the feature on, use the SEEK or SCAN control to find a radio station broadcasting a traffic report (if it is broadcasting RDS data).

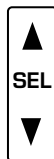

Traffic information is not available in most U.S. markets.

Program type

- Press the RDS control until FIND program type is displayed.



- Use the SEL control to select the program type. With the feature on, use the SEEK or SCAN control to find the desired program type from the following selections:

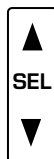

- Classic
- Country
- Info
- Jazz
- Oldies
- R & B
- Religious
- Rock
- Soft
- Top 40

Controls and features

Show

- RDS sends information with the FM broadcast: station name, station type, and/or radio text.
- With RDS activated, press the RDS control until SHOW is displayed.
- Use the SEL control to select (program) TYPE, (station) NAME or NONE (no text displayed).

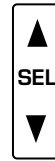

Mute mode

Press the control to mute the playing media. Press the control again to return to the playing media.



Digital signal processing (if equipped)

The digital signal processing (DSP) feature allows you to change the signal mode to suit your listening tastes.

Press the control to turn the feature on or off.

Use the SEL control to select the desired signal mode (the selected mode will appear in the display). The following signal modes can be selected:

- JAZZ CLUB—jazz club with clearly reflected sounds.
- HALL—rectangular concert hall capacity of about 2 000.
- CHURCH—church with a high vault.
- STADIUM—outdoor stadium with a capacity of about 30 000.
- NEWS—"voice-only" type of sound with a limited audio band.

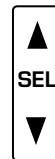

Controls and features

Press the DSP control until one of the following appears:

- ALL SEATS
- DRIVER SEAT
- REAR SEATS



Use the SELECT control to change the equalization to the desired mode.



CD changer (if equipped)

Your CD changer is either located in the passenger's footwell area or in the center console.

Slide the door to access the CD changer magazine.

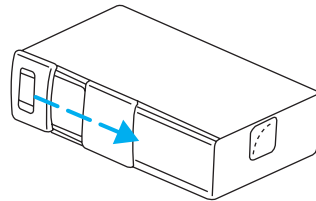

Press ▲ to eject the magazine.

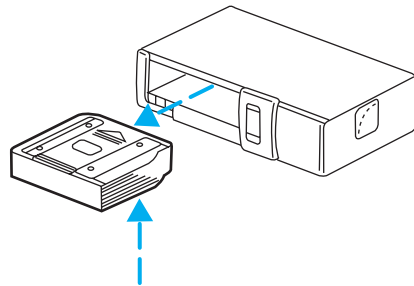

Controls and features

1. Pull the lever to remove a CD tray from the magazine.

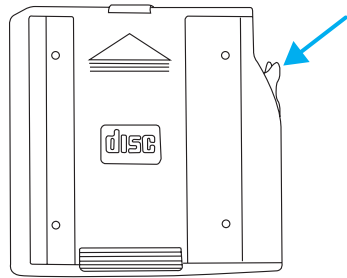

2. Insert one disc into each CD tray of the magazine (up to 6 discs). Ensure that the label side is facing up.

If you pull too hard on the disc holder, the disc holder may come completely out of the magazine. If this happens, reinsert the disc holder back into the magazine.

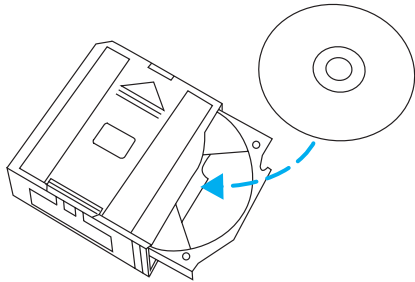

3. Insert each CD tray, with the disc loaded, all the way into the CD magazine.

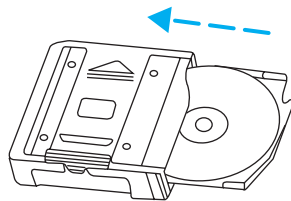

4. Insert the CD magazine into the changer.

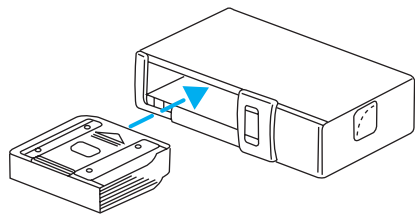

Controls and features

5. Slide the door to the left to close.

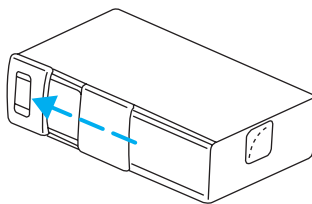

Use only compact discs containing this mark.



The magazine does not need to be full for the changer to operate.

Radio power must be turned on to play the CDs in the changer. The magazine may be stored in the glove compartment when not being used.

The CD magazine may be inserted or ejected with the radio power off.

Keep the CD changer door closed. Coins and foreign objects will damage the CD player and void your audio system warranty.

Do not insert any promotional (odd shaped or sized) discs, or discs with removable labels into the CD changer as that jamming may occur.

Troubleshooting the CD changer (if equipped)



The laser beam used in the compact disc player is harmful to the eyes. Do not attempt to disassemble the case.

If sound skips:

- You may be traveling on a rough road, playing badly scratched discs or the disc may be dirty. Skipping will not scratch the discs or damage the player.

If your changer does not work, it may be that:

- A disc is already loaded where you want to insert a disc.
- The disc is inserted with the label surface downward.
- The disc is dusty or defective.
- The player's internal temperature is above 60°C (140°F). Allow the player to cool down before operating.

Controls and features

- A disc with format and dimensions not within industry standards is inserted.

Cleaning compact discs

Inspect all discs for contamination before playing. If necessary, clean discs only with an approved CD cleaner and wipe from the center out to the edge. Do not use circular motion.

CD and CD changer care

- Handle discs by their edges only. Never touch the playing surface.
- Do not expose discs to direct sunlight or heat sources for extended periods of time.
- Do not insert more than one disc into each slot of the CD changer magazine.

Cleaning cassette player

Clean the tape player head with a cassette cleaning cartridge after 10 to 12 hours of play in order to maintain the best sound and operation.

Cassette and cassette player care

- Use only cassettes that are 90 minutes long or less.
- Do not expose tapes to direct sunlight, high humidity, extreme heat or extreme cold. Allow tapes that may have been exposed to extreme temperatures to reach a moderate temperature before playing.
- Tighten very loose tapes by inserting a finger or pencil into the hole and turning the hub.
- Remove loose labels before inserting tapes.
- Do not leave tapes in the cassette player for a long time when not being played.

Radio frequency information

The Federal Communications Commission (FCC) and the Canadian Radio and Telecommunications Commission (CRTC) establish the frequencies AM and FM stations may use for their broadcasts. Allowable frequencies are:

AM 530, 540–1600, 1610 kHz

FM 87.7, 87.9–107.7, 107.9 MHz

Not all frequencies are used in a given area.

Controls and features

Radio reception factors

Three factors can affect radio reception:

- **Distance/strength.** The further an FM signal travels, the weaker it is. The listenable range of the average FM station is approximately 40 km (24 miles). This range can be affected by “signal modulation.” Signal modulation is a process radio stations use to increase their strength/volume relative to other stations.
- **Terrain.** Hills, mountains and tall buildings between your vehicle’s antenna and the radio station signal can cause FM reception problems. Static can be caused on AM stations by power lines, electric fences, traffic lights and thunderstorms. Moving away from an interfering structure (out of its “shadow”) returns your reception to normal.
- **Station overload.** Weak signals are sometimes captured by stronger signals when you pass a broadcast tower. A stronger signal may temporarily overtake a weaker signal and play while the weak station frequency is displayed.

The audio system automatically switches to single channel reception if it will improve the reception of a station normally received in stereo.

Audio system warranties and service

Refer to the “Warranty Guide” for audio system warranty information.

If service is necessary, see your dealer or a qualified technician.

POSITIONS OF THE IGNITION

1. ACCESSORY, allows the electrical accessories such as the radio to operate while the engine is not running.
2. LOCK, locks the steering wheel, automatic transmission gearshift lever and allows key removal.
3. OFF, shuts off the engine and all accessories without locking the steering wheel.
4. ON, all electrical circuits operational. Warning lights illuminated. Key position when driving.

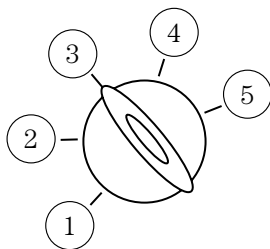

Controls and features

5. START, cranks the engine. Release the key as soon as the engine starts.

Refer to the *Securilock™ Passive Anti-Theft System* section in this chapter for more information on Securilock™ keys.

KEY SYSTEM

The vehicle is equipped with a master key and valet key lock system. The master key will actuate doors, trunk, glove box, ignition and remote trunk release. The valet key (marked “valet”) will actuate doors and ignition only.

WINDSHIELD WIPER/WASHER CONTROLS

Rotate the windshield wiper control to the desired interval, low or high speed position.

The bars of varying length are for intermittent wipers. When in this position rotate the control upward for fast intervals and downward for slow intervals.

Push the control on the end of the stalk to activate washer. Push and hold for a longer wash cycle. The washer will automatically shut off after ten seconds of continuous use.

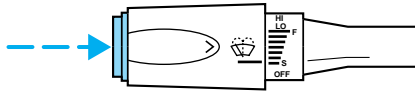
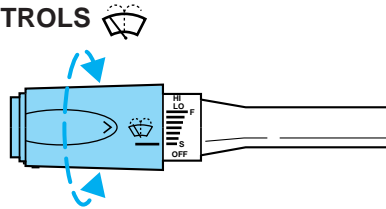

Windshield wiper/washer features

The exterior lamps will illuminate when the ignition is ON and the windshield wiper control is in the interval, LO or HI position.

The instrument panel lighting will dim noticeably approximately 15 seconds after the wipers are turned on. The lights will remain in this state until 30 seconds after the wipers are turned off.

Controls and features

TURN SIGNAL CONTROL ↵↶

- Push down to activate the left turn signal.
- Push up to activate the right turn signal.

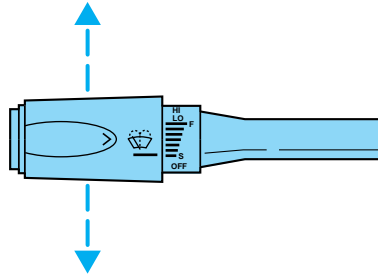

Cornering lamps

When the turn signal is used and the headlamps are on, the cornering lamps will light either the right or left side depending on the direction of the turn.

The flash rate of the turn signal will speed up considerably if the Lighting Control Module detects a left or right turn lamp bulb (front or rear) is burned out.

STEERING WHEEL CONTROLS (IF EQUIPPED)

Radio control features

- Press BAND/MODE to select AM, FM1, FM2, TAPE or CD (if equipped).

In Radio mode:

- Press MEM/NEXT to select a preset station from memory.

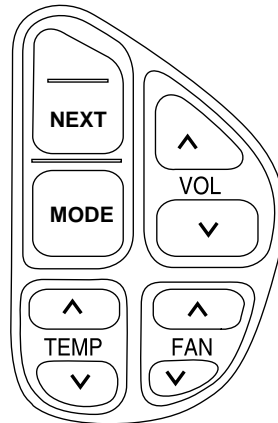

Controls and features

In Tape mode:

- Press MEM/NEXT to listen to the next selection on the tape.

In CD mode:

- Press MEM/NEXT to listen to the next track on the disc.

In any mode:

- Press VOL up or down to adjust the volume.

Climate control features

- Press TEMP up or down to adjust temperature.
- Press FAN up or down to adjust fan speed.

SPEED CONTROL

To turn speed control on

- Press ON.

Vehicle speed cannot be controlled until the vehicle is traveling at or above 48 km/h (30 mph).

When the ON control is pressed, the message “SPEED CONTROL READY” will appear for 5 seconds in your message center. Or, if the speed control is already ON and SET, the message “SPEED CONTROL SET” will appear for 5 seconds in your message center.

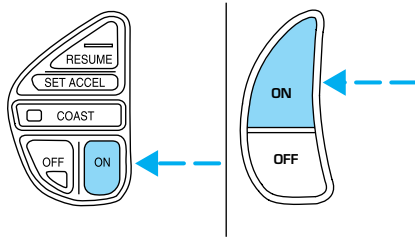

Do not use the speed control in heavy traffic or on roads that are winding, slippery, or unpaved.



Do not shift the gearshift lever into N (Neutral) with the speed control on.

Controls and features

To turn speed control off

- Press OFF or
- Turn off the vehicle ignition.

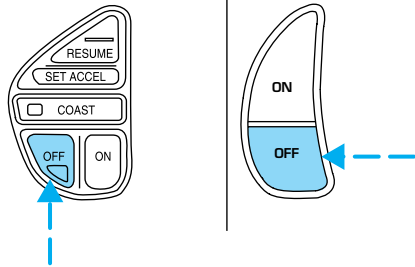

Once speed control is switched off, the previously programmed set speed will be erased.

When the OFF control is pressed, the message “SPEED CONTROL OFF” will appear for 5 seconds in your message center.

To set a speed

- Press SET ACC/SET ACCEL. For speed control to operate, the speed control must be ON and the vehicle speed must be greater than 48 km/h (30 mph).

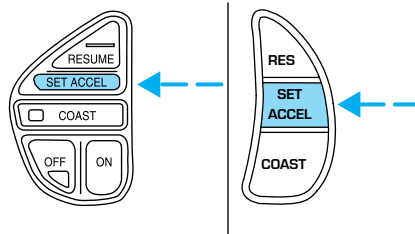

When the SET ACCEL control is pressed, the message “SPEED CONTROL SET” will appear for 5 seconds in your message center.

If you drive up or down a steep hill, your vehicle speed may vary momentarily slower or faster than the set speed. This is normal.

Speed control cannot reduce the vehicle speed if it increases above the set speed on a downhill. If your vehicle speed is faster than the set speed while driving on a downhill, you may want to shift to the next lower gear or apply the brakes to reduce your vehicle speed.

If your vehicle slows down more than 16 km/h (10 mph) below your set speed on an uphill, your speed control will disengage. “SPEED CONTROL CANCELED” will appear for 5 seconds in your message center. This is normal. Pressing RES/RESUME will re-engage it.

Controls and features



Do not use the speed control in heavy traffic or on roads that are winding, slippery, or unpaved.

To set a higher set speed

- Press and hold SET ACCEL. Release the control when the desired vehicle speed is reached or
- Press and release SET ACCEL. Each press will increase the set speed by 1.6 km/h (1 mph) if (E) English is selected or 2 km/h (1.25mph) if (M) Metric is selected in the Message Center.
- Accelerate with your accelerator pedal, then press and release SET ACCEL.

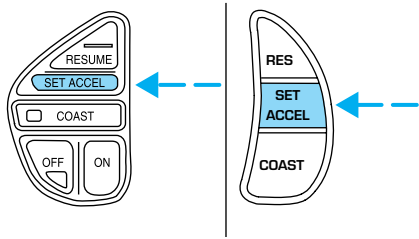

When the SET ACCEL control is pressed and released, the message “SPEED CONTROL SET” will appear for 5 seconds in your message center.

You can accelerate with the accelerator pedal at any time during speed control usage. Releasing the accelerator pedal will return your vehicle to the previously programmed set speed.

To set a lower set speed

- Press and hold COAST. Release the control when the desired speed is reached or
- Press and release COAST. Each press will decrease the set speed by 1.6 km/h (1 mph) if (E) English is selected or 2km/h (1.25 mph) if (M) Metric is selected in the Message Center.

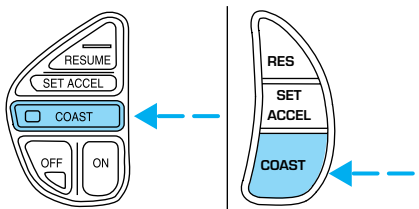

Controls and features

- Depress the brake pedal. When the desired vehicle speed is reached, press SET ACCEL.

When the COAST or SET ACCEL control is pressed and released, the message “SPEED CONTROL SET” will appear for 5 seconds in your message center.

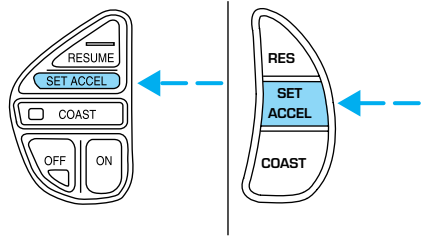

To disengage speed control

- Depress the brake pedal.

When the brake pedal is depressed, the message “SPEED CONTROL CANCELED” will appear for 5 seconds in your message center.

Disengaging the speed control will not erase the previously programmed set speed.

- Press the OFF control.

Pressing OFF will erase the previously programmed set speed.

When the OFF control is pressed, the message “SPEED CONTROL OFF” will appear for 5 seconds in your message center.

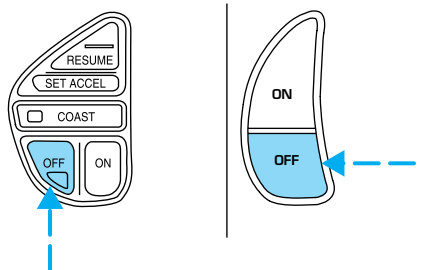

To return to a previously set speed

- Press RES/RESUME. For RES/RESUME to operate, the vehicle speed must be faster than 48 km/h (30 mph).

When the RESUME control is pressed, the message “SPEED CONTROL SET” will appear for 5 seconds in your message center.

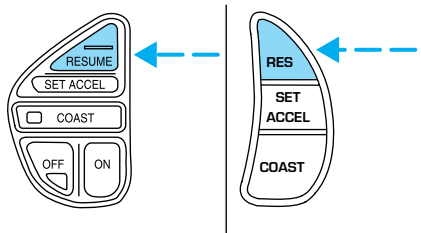

Controls and features

TILT STEERING

Pull the tilt steering control toward you to move the steering wheel up or down. Hold the control while adjusting the wheel to the desired position, then release the control.

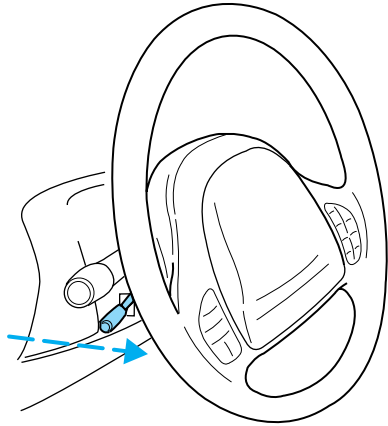

Never adjust the steering wheel when the vehicle is moving.

INTERIOR LAMPS

Map lamps

To turn on the map lamps, press the control next to each lamp.

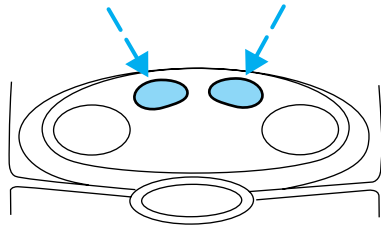

Controls and features

If equipped with a moon roof, the map lamps are located on the rearview mirror. Press the control next to the map lamp to illuminate the lamp.

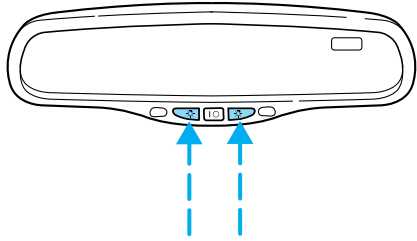

Rear courtesy/reading lamps

The courtesy lamp lights when:

- any door is opened.
- the instrument panel dimmer switch is held up until the courtesy lamps come on.
- any of the remote entry controls are pressed and the ignition is OFF.

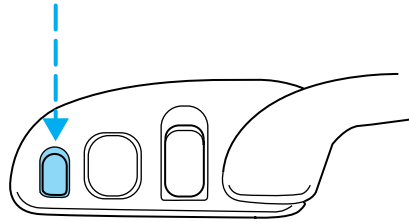

With the ignition key in the ACC or ON position, the reading lamp can be turned on by pressing the rocker control.

LINCOLN RESCU SYSTEM (IF EQUIPPED)

Lincoln RESCU runs a self-test when you start your vehicle. During this test, the Lincoln RESCU warning light (located in the overhead console) will illuminate for several seconds. If the phone is disconnected, or a problem is detected during the self-check, the light will remain lit and the message “RESCU FAILURE” will be displayed on the vehicle’s message center for several seconds.

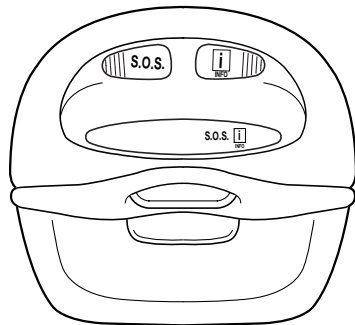

Controls and features

If the phone is properly connected and the warning light fails to illuminate when you start your vehicle, or if it remains lit, have your Lincoln RESCU System checked by an authorized dealer as soon as possible. Your system may be inoperative.



It is important that you understand the limitations of your Lincoln RESCU System prior to initiating an activation. See *Lincoln RESCU System Limitations* later in this chapter for details.

The RESCU system can be activated in three ways:

1. By pressing the Information control.

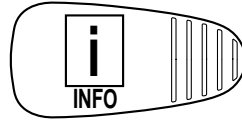

2. By pressing the Emergency (S.O.S.) control.

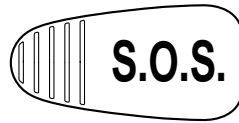

3. The system will automatically activate if the vehicle's air bags have been deployed.

Quick summary

- To utilize your vehicle's RESCU system, your cellular phone must be activated and plugged into the vehicle interface.
- Information or emergency assistance can be requested whenever your key is in the RUN/START position and for six minutes after the vehicle is turned off.
- An assistance request is initiated by pressing either the Information or Emergency control located in the overhead console.
- When a control is pressed, a warning lamp located in the overhead console will begin to flash and status messages will display on the vehicle's message center (messages can only be displayed when the key is in the RUN/START position).

Controls and features

- The vehicle's cellular phone automatically places a call to a 24 hour emergency response center.
- When contact is made, the vehicle sends an electronic data message to the response center's computer. This data message includes latitude and longitude coordinates obtained from the vehicle's positioning system and customer identification information.
- Once the data transmission is complete, the call is forwarded to a response center operator who confirms your location using a computerized map.
- The vehicle's cellular handset is locked-out, the phone is automatically placed in the "hands-free" mode and voice communication is established with the operator through the "hands-free" microphone.
- Typically, voice communication with an operator is established within one minute after an assistance control is pressed.
- The operator verbally obtains details of your situation and, if necessary, ties your vehicle into a three-way phone call with the United States Auto Club or local 911 or other emergency services to dispatch the appropriate assistance to your location.
- In most situations, only the response center can terminate an assistance request. Once the operator terminates the call, the system warning light will stop flashing and the system will be reset.

General description

Lincoln's Remote Emergency Satellite Cellular Unit (RESCU) is designed to expedite roadside, emergency or information assistance to motorists who are uncertain of their location and/or are uncertain of whom to contact for assistance.

The Lincoln RESCU system utilizes Global Positioning System (GPS) technology and the nation's cellular phone network to track vehicle location and, at the touch of a control, put you in voice contact with the Lincoln Security Response Center.

Two controls in the overhead console, Information (i) and Emergency (S.O.S.) will activate the system:

When a control is selected, the RESCU System will direct the vehicle's cellular phone to automatically place a call to the response center's central computer. Once a connection is made, an electronic data message will be transmitted. This data message will include:

- Type of alarm (Information, Emergency or Air Bag activation)

Controls and features

- Customer Identification Number (CID)
- Latitude and longitude coordinates
- Last recorded speed and direction of the vehicle
- Time tag identifying when last position was taken
- Call-back phone number

After the transmission is complete, the call is forwarded to an operator who will verify the details of the request and confirm the vehicle's location using a computerized map.

Information Control

The Information control provides the customer access to the information such as points of interest near their current location, route assistance and other services as they become available.

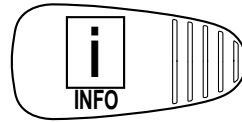

There may be charges incurred for certain services.

The Emergency (S.O.S.) control should be selected if emergency assistance is required. This feature should be used:

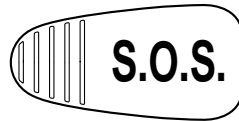

- if you have been involved in an accident.
- to report a crime or fire.
- when medical attention is required.
- to receive assistance in an emergency situation.

There may be charges incurred for certain services.

Upon receiving an Emergency Activation (by pressing the emergency control or via an air bag activation) the Lincoln Security Response Center relays details of the situation and the location of the vehicle to the appropriate authorities and establishes a three-way phone call. While the appropriate authorities dispatch help to your location, the response center will:

- dispatch the emergency help to your location.
- when appropriate, stay in direct phone contact with you until emergency help arrives.

Controls and features

- notify pre-designated family contacts or friends of the emergency situation, if requested, or if no response is received from the vehicle.

If you are certain of your location, a direct phone call to 911 or other emergency services may provide a faster response.

If roadside assistance is required, the Lincoln Security Response Center will contact the Lincoln Commitment Roadside Assistance provider via three-way phone call.

Activation and deactivation

When either of the two Lincoln RESCU controls are pressed, or the air bags are deployed (this will activate the system as an emergency automatically), a warning light, located in the overhead console, will begin to flash and status messages will be displayed on the vehicle's message center, confirming an assistance request has been made. The warning light will continue to flash throughout the activation.

The system can be activated whenever your ignition key is in the RUN/START position and for six minutes after your vehicle is turned off. Once a RESCU control has been pressed, do not attempt to crank the engine as this may cancel the activation. In most situations, the assistance request can only be terminated and the system reset when a special tone is sent to the vehicle by the Lincoln Security Response Center. (See *Automatic redial* later in this chapter for exceptions.) Operation will continue even if the vehicle is turned off during an activation (although visual feedback via the message center will not be available in this situation).

INFO activations can be cancelled by pressing the END button on the cellular phone.

Cellular phone interface

The cellular phone must be connected to the vehicle and activated for the system to work. During an activation, Lincoln RESCU takes control of the vehicle's cellular phone. If the phone is in use, the call will be terminated and the Lincoln Security Response Center will automatically be dialed. The cellular handset becomes inoperative and all voice communication with the operator is accomplished via the cellular phone's "hands-free" microphone.

When an activation is terminated, your phone is left unlocked, in the ON state and may not return to its previous call restriction or system selection setting. It can be reprogrammed to your previous setting as desired.

Controls and features

Refer to your cellular phone user's manual for further information.

Message center interface

During an activation, Lincoln RESCU communicates with the vehicle's message center. Status messages describing the sequence of the steps being executed are displayed, allowing you to visually follow the activation process. The following messages are typical of those displayed during an assistance request. They are as shown in the order in which they would appear:

- INFO REQUEST or S.O.S. REQUEST
- CALL IN PROGRESS
- RINGING RESPONSE CENTER
- SENDING LOCATION DATA
- DATA RECEIVED
- WAITING FOR OPERATOR

Once an assistance request is made, it will typically take less than one minute until contact is made with an operator. During voice communication the following messages will alternately toggle on the display:

- CID XXXXXXXXXXXX
- LAT XXXXXXXXXXXX
- LON XXXXXXXXXXXX
- HDG XX

These messages respectively are the customer identification number, vehicle latitude and vehicle longitude. Under special conditions, the operator may ask you to read the information being displayed on the message center.

Automatic redial

As described previously, when an assistance request is made, the vehicle's cellular phone automatically dials the Lincoln Security Response Center's central computer and attempts to send an electronic data message. On rare occasions, it can be difficult for the computer to recognize the message if the cellular connection is weak or noisy. If the transmission of the message is unsuccessful, the data call will be terminated and the message "REDIAL IN PROGRESS" will be displayed on the message center. A second call will automatically be placed which

Controls and features

bypasses the response center's computer and is forwarded directly to an operator.

Similarly, if the cellular call is disconnected by the network prior to receipt of the termination tone, another call to the response center will also automatically be dialed. The message "REDIAL IN PROGRESS" will be displayed on the message center and voice communication with an operator will be restored.

During redial calls, full control of the cellular phone is returned to you. Pressing either PWR or END on the cellular handset will terminate the assistance request and reset the system.

Location data retransmit capability

During an activation, the Lincoln Security Response Center operator has the capability to initiate a retransmission of the electronic data message. This may be necessary to ensure a more precise determination of vehicle location or to track a vehicle that is moving. To accomplish the retransmit, a special tone is sent to the vehicle by the response center. In this situation you will temporarily lose voice contact with the operator and the messages "SENDING LOCATION DATA" and "DATA RECEIVED" will be respectively displayed on the message center. After the data retransmission is complete, voice communication will be restored and the CID, LAT, LON and HDG message will again alternately toggle on the message center display.

Global positioning system

Vehicle location is continuously updated via Global Positioning System (GPS) technology. GPS was developed by the U.S. Department of Defense for worldwide navigational and positioning purposes. It utilizes a constellation of 24 orbiting satellites located more than 20 000 km (12 428 miles) above the earth. At any given time, several of the 24 satellites should be visible to the vehicle's GPS receiver. Based on the time for signals emitted by these satellites to reach the receiver, an on-board computer will determine the vehicle's location, typically within 30 meters (100 feet). In addition to latitude and longitude, the system also determines heading and speed.

Vehicle positioning information is relayed to the Lincoln Security Response Center only during roadside or emergency requests. The response center will not be able to track your location while in an inactive state.

Controls and features

Lincoln RESCU system limitations

- **Inoperative if cellular phone inactive or inoperative**

Lincoln RESCU utilizes your vehicle's cellular phone and will not operate if cellular service has not been activated or if the phone is inoperative.

- ***Inoperative if battery discharged or disconnected***

Lincoln RESCU is powered by the vehicle's battery and will not operate if the battery is discharged or disconnected.

- ***Inoperative if cellular phone is not installed in the vehicle interface***

Lincoln RESCU utilizes your vehicle's cellular phone and will not operate if cellular phone is not installed in the vehicle interface.

- ***Potentially inoperative if vehicle involved in accident***

If the vehicle is involved in an accident, some components can be damaged, rendering your RESCU System inoperative.

- ***Positioning capability degraded if satellite signals obstructed***

Vehicle positioning is accomplished by receiving and interpreting signals transmitted by satellites. If the signals are obstructed positioning capability could be degraded or lost. This situation will be most prevalent in urban areas populated with tall buildings, tunnels, underpasses, parking garages, trees and similar structures could also adversely affect positioning performance. Under these conditions, the system will operate but the response center could have difficulty identifying your current location. (The last valid position obtained before the obstruction is retained, however, and will be sent.) The operator may depend on you to provide verbal information regarding vehicle location.

- ***Positioning capability temporarily degraded after battery reconnect***

When your vehicle is started, the Lincoln RESCU GPS receiver begins the process of determining vehicle location. The receiver will search the sky and attempt to acquire signals from all visible satellites. A real-time clock and an almanac containing detailed information about satellite constellation are stored in the on-board computer's memory and are used to expedite the search. If the vehicle's battery is disconnected, the clock memory is erased and time and date are lost. Once the battery is reconnected, it could take approximately 15 minutes to reacquire the clock and for positioning capability to be restored. During this time, the

Controls and features

system will operate but the response center will not be able to identify your location. In this situation, the operator will depend on you to provide verbal information regarding vehicle location.

- ***Inoperative if cellular signal marginal or unavailable***

Since the Lincoln RESCU System utilizes the vehicle's cellular phone, it can only be operated in geographical areas with cellular coverage. Although approximately 90 percent of the U.S. population lives and works in cellular coverage areas, there are various rural or mountainous areas where coverage is marginal or does not exist. If an activation occurs in this situation, the messages "NO CELLULAR SIGNAL" and "WAITING TO ACQUIRE" will alternately be displayed on the message center. If after several attempts cellular service can not be acquired, the message "UNABLE TO PLACE CALL" will be displayed, the assistance request will be terminated and the phone will return to its normal operating mode.

- ***Inoperative if cellular system is busy***

In a particular area, the local cellular system can only handle a limited number of cellular calls at one time. Once volume has reached the maximum limit, additional callers are denied access. If an activation occurs in this situation, the messages "CELLULAR SYSTEM BUSY" and "PLEASE WAIT" will alternately be displayed on the message center. If after several attempts a cellular channel cannot be acquired, the message "UNABLE TO PLACE CALL" will be displayed, the assistance request will be terminated and the phone will return to its normal operating mode.

- ***Incompatible with cellular PIN feature***

Some cellular carriers offer custom phone numbers that are assigned a personal identification number (PIN). In this situation, the user is required to enter the PIN with any phone calls made over the network. The PIN feature is not compatible with the Lincoln RESCU System. At the time your phone is activated, ask your carrier to assign you a phone number that does not require a personal identification number. If you have difficulty obtaining a non-PIN number, contact your dealer or call the Ford Cellular System Clearinghouse at 1-800-367-3357 for assistance.

Controls and features

- ***Incompatible or performance limited with certain cellular providers features***

Some cellular carriers offer customers various optional features with their cellular services. Several of these features are not compatible or could potentially limit the performance of your Lincoln RESCU System. Some outgoing calls, hotline and NPA restrictions are incompatible cellular features and must be avoided. Operation is possible with no incoming calls, call forwarding, busy/no answer transfer and call waiting, but these features could impact overall system performance. Because carriers are regularly making new features available to customers, this list may not be complete. Contact your dealer for assistance if you are unsure if a particular cellular feature is compatible with your Lincoln RESCU System.

- ***Potential limitations if activated outside home cellular region***

At the time you receive your vehicle (or shortly after), you will need to select a cellular carrier and activate your phone. If desired, carrier selection can be arranged through your dealer. This carrier is usually local to your region and will handle call processing and billing services for your cellular telephone. In order to use your phone when traveling outside your home cellular region, the services of the carriers local to the new area will be required. If your home carrier does not have an agreement with the new local carrier, your phone calls could be forwarded to an operator and you may be required to provide a credit card number before your call is processed. If an activation occurs in this situation, the initial call will be terminated and a second call which bypasses the response center's computer will be placed.

Unlike during the first call attempt, your cellular handset will not be locked during the second call, so you will have the option of terminating the assistance request at any time by pushing either PWR or END on the cellular phone. If the second call is not terminated, it will be forwarded to a local cellular carrier operator. In this situation, you can provide the operator with the number you are dialing (Lincoln Security Response Center at 1-888-99RESCU [1-888-997-3728]) and your credit card number or ask to be connected to the local 911 or other emergency services.

Registration requirement

In order to receive effective service, it is highly recommended that you register with the Lincoln Security Response Center shortly after receiving your vehicle. The registration process is simple and can be

Controls and features

accomplished by calling the Lincoln Security Response Center at 1-888-99RESCU (1-888-997-3728). Alternatively, the registration process can be completed on-line during an acquaintance period activation. (See “Acquaintance activations” later in this section for details.) The information requested will aid in servicing you more efficiently during an assistance request.

Acquaintance activations

It is required that you initiate an acquaintance activation shortly after receiving your vehicle and having your phone activated. An acquaintance activation is initiated by pressing either the roadside or emergency control. When voice communication is established with the Lincoln Security Response Center, indicate that you are a new user and the operator will follow special acquaintance period support procedures which are intended to familiarize you with your Lincoln RESCU System. As described previously, the acquaintance call can also be used to complete the registration for new customers.

Service charges

For four years, beginning with your vehicle’s warranty period, you will be entitled to unlimited emergency and roadside assistance activations without facing service charges. (These activations should be made only when emergency or roadside assistance is required.) You will be responsible, however, for any charges imposed by your cellular phone carrier for the 1-800 phone call to the Lincoln Security Response Center. After your initial service period expires, you will be required to pay a monitoring fee if you elect to continue emergency and roadside assistance. Your dealer can provide you with specific information regarding post-initial service period fees.

Relinquishing your vehicle

At the time you relinquish your vehicle, it is important that you contact the Lincoln Security Response Center at 1-888-99RESCU (1-888-997-3728) and cancel your security service. Personal information provided to the response center at the time of your registration will be removed from the vehicle’s file.

Controls and features

MOON ROOF (IF EQUIPPED)

To open the moon roof:

- Press and hold the control forward to raise the moon roof to the vent position (when the glass panel is closed).
- Press the control rearward to fully open the moon roof.

To close the moon roof:

- Press the control forward.
- To close from the vent position, press and hold the control rearward.

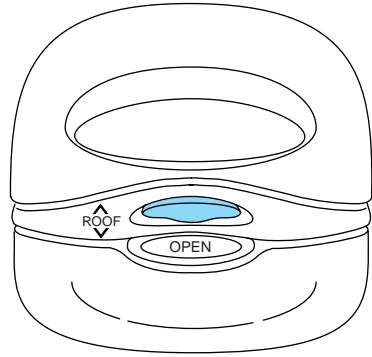

ILLUMINATED VISOR MIRROR

To turn on the visor mirror lamps, lift the mirror cover. Adjust the amount of light by sliding the control.

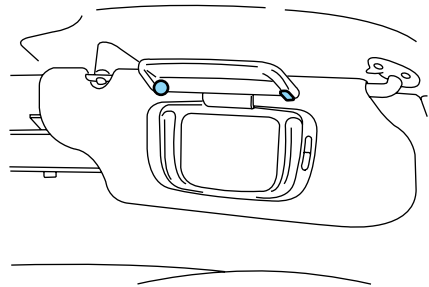

HOMELINK® UNIVERSAL TRANSCEIVER (IF EQUIPPED)

The HomeLink® Universal Transceiver, located on the driver's visor, provides a convenient way to replace up to three hand-held transmitters with a single built-in device. This feature will learn the radio frequency codes of most current transmitters to operate garage doors, entry gates, security systems, entry door locks, and home or office lighting.



When programming your HomeLink® Universal Transceiver, to a garage door or gate be sure that people and objects are out of the way to prevent potential harm or damage.

Controls and features

Do not use the HomeLink® Universal Transceiver with any garage door opener that lacks safety stop and reverse features as required by U.S. federal safety standards (this includes any garage door opener model manufactured before April 1, 1982). A garage door which cannot detect an object, signaling the door to stop and reverse, does not meet current U.S. federal safety standards. For more information on this matter, call toll-free: 1-800-355-3515 or on the Internet at **HomeLink.jci.com**.

Programming

1. Prepare for programming the HomeLink® Universal Transceiver by erasing the three factory default codes by holding down the two outside buttons until the red light begins to flash after 20 seconds. Release both buttons.

2. Hold the end of your hand-held transmitter 5–14 cm (2–5 inches) away from the HomeLink® Universal Transceiver surface (located on your visor) while keeping the red light in view.

3. Using both hands simultaneously press and hold the hand-held transmitter button and the desired HomeLink® button. Do not release the buttons until step 4 has been completed.

4. The red light will flash slowly and then rapidly. Release both buttons when the red light flashes rapidly.

5. Follow steps 2 through 4 to program the remaining two buttons.

If you do not successfully program the HomeLink® Universal Transceiver after repeated attempts, refer to *Rolling code programming* which follows, or call toll-free customer assistance: 1-800-355-3515 or on the Internet at **HomeLink.jci.com**.

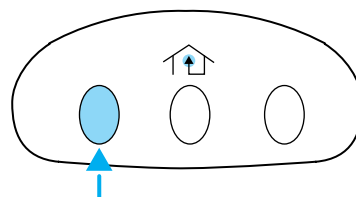
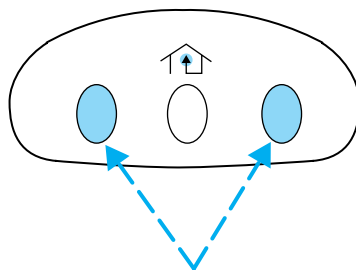

Controls and features

Canadian Programming

During programming, your hand-held transmitter may automatically stop transmitting after two seconds which may not be long enough to program the HomeLink® Universal Transceiver.

To program your hand-held transmitters:

- continue to hold the button on the HomeLink® Universal Transceiver.
- press and re-press the hand-held transmitter button every two seconds until the red light changes from a slow to a fast flash.

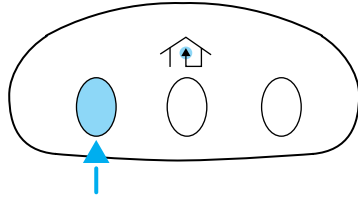

Operating the HomeLink® Universal Transceiver

Once programmed, the HomeLink® Universal Transceiver can be used in place of hand-held transmitters. To operate, simply press and release the appropriate HomeLink® button (the red light will illuminate, indicating the signal is being transmitted).

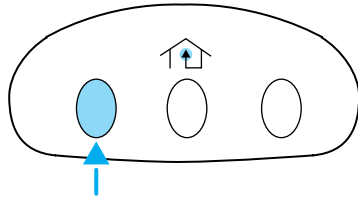

Rolling code programming

Rolling code garage door openers (or other rolling code devices) which are “code protected” and manufactured after 1996, may be determined by the following:

- Reference the device owner’s manual for verification
- The hand-held transmitter appears to program the HomeLink® Universal Transceiver but does not activate the device.
- Press and hold the trained HomeLink® button. The device has the rolling code feature if the indicator light flashes rapidly and then turns solid after two seconds.

After completing the “Programming” functions, follow these steps to train a garage door opener with the rolling code feature:

Controls and features

1. Locate the **training button** on the garage door motor head unit. Refer to the garage door opener manual or call 1-800-355-3515 or on the Internet at **HomeLink.jci.com**. if there is difficulty locating the training button.
2. Press the training button on the garage door motor head unit (which will activate the **“training” light**).
3. Press and release the programmed HomeLink® button. Press and release the HomeLink® button a *second time* to complete the training process. (Some garage door openers may require this procedure to be done a third time to complete the training).

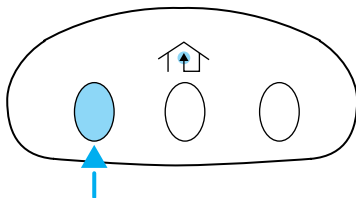

The 2nd or 3rd press from step 3 will activate the door. The HomeLink® Universal Transceiver has now been trained to the receiver. The remaining two buttons may now be programmed if this has not previously been done.

Erasing HomeLink® buttons

Individual buttons cannot be erased, however, to erase the three programmed buttons:

1. Hold down the two outside buttons until the red light begins to flash after 20 seconds.
2. Release both buttons.

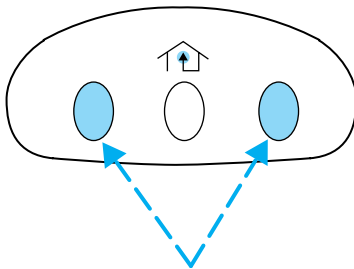

Reprogramming a single HomeLink® button

To program a device to HomeLink® using a HomeLink® button previously trained, follow these steps:

1. Press and hold the desired HomeLink® button. **Do NOT** release until **step 4** has been completed.
2. When the indicator light begins to flash slowly (after 20 seconds), position the hand-held transmitter 5–14 cm (2 to 5 inches) away from the HomeLink® surface.

Controls and features

3. Press and hold the hand-held transmitter button.
4. The HomeLink® indicator light will flash, first slowly and then rapidly. When the indicator light begins to flash rapidly, release both buttons. The previous device has now been erased and the new device can be activated by pushing the HomeLink® button that has just been programmed.

ELECTRONIC COMPASS (IF EQUIPPED)

The compass reading may be affected when you drive near large buildings, bridges, power lines and powerful broadcast antennas. Magnetic or metallic objects placed in, on or near the vehicle may also affect compass accuracy.

Usually, when something affects the compass readings, the compass will correct itself after a few days of operating your vehicle in normal conditions. If the compass still appears to be inaccurate, a manual calibration may be necessary. Refer to *Compass calibration adjustment*.

Most geographic areas (zones) have a magnetic north compass point that varies slightly from the northerly direction on maps. This variation is four degrees between adjacent zones and will become noticeable as the vehicle crosses multiple zones. A correct zone setting will eliminate this error. Refer to *Compass zone adjustment*.

Controls and features

Compass zone adjustment

The compass in the mirror is set in ZONE eight at the factory. It may be necessary to adjust the compass if you live outside zone eight or during a long distance trip.

1. Determine which magnetic zone you are in for your geographic location by referring to the zone map.
2. Turn the ignition to the ON position.

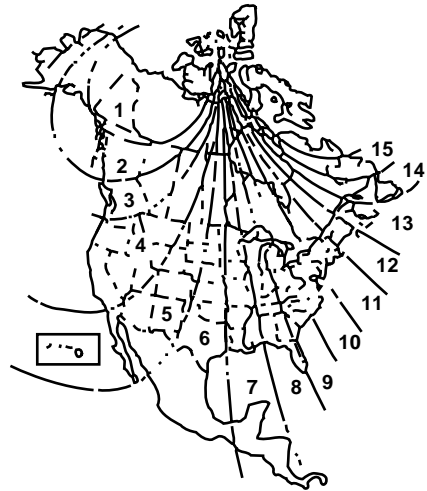

Without moon roof:

1. With the compass display turned on, press and hold the COMP side of the control until the zone selection number appears in the mirror display window.
2. Release the COMP side of the control, then press it down again.
3. Continue to press until your zone number is shown in the mirror display, then release.
4. The display will show all segments, then return to normal compass mode within ten seconds.

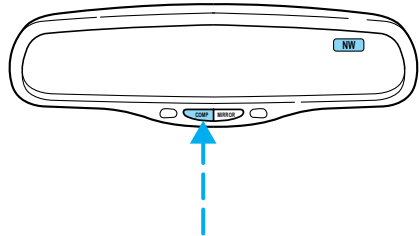

Controls and features

With moon roof:

1. Press and hold the Auto-Dimming control to toggle the Compass display ON/OFF, then release.

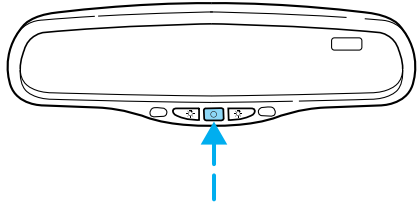

2. Press and hold both map light buttons, between 5 and 8 seconds, until the ZONE number appears in the display, then release. The display should show the current zone number.

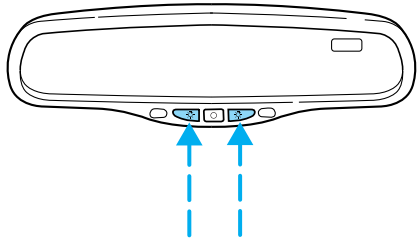

3. Press either the right or left map light button to change the zone number. The display will show a compass direction after 5 seconds. The zone is now updated.

Compass calibration adjustment

The compass may need calibration adjustment if:

- the compass ZONE is set correctly and the compass is not showing the correct heading
- the letter “C” is displayed in the compass window

Perform this adjustment in an open area free from steel structures and high voltage lines.

Without moon roof:

1. Start the vehicle.
2. Press and hold the COMP side of the control for approximately six seconds until “C” appears in the mirror display.
3. Drive the vehicle slowly (less than 5 km/h [3 mph]) in circles or on your everyday routine until the display reads a direction.
4. The compass is now calibrated.

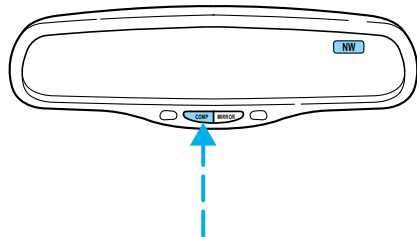

Controls and features

With moon roof:

1. Start the vehicle.
2. Press and hold both map light buttons for over 8 seconds, until the letter “C” appears in the display, then release.
3. Drive the vehicle slowly (less than 8 km/h [5 mph]) in circles until the letter “C” display indicates a direction.

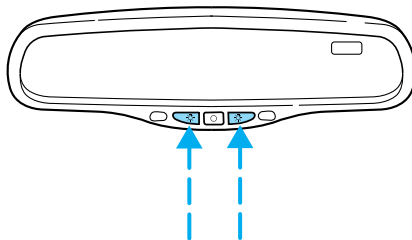

Compass zone adjustment

1. Determine which compass zone you are in by referring to the zone map.

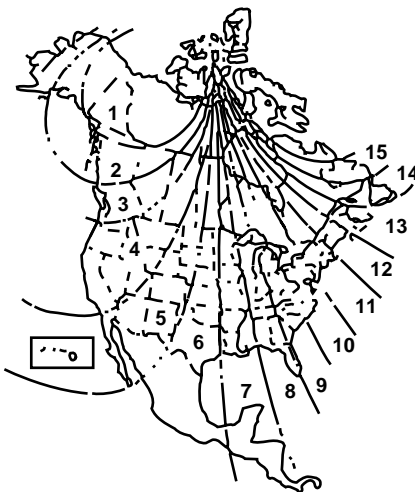

2. With the compass display turned on, press and hold the COMP side of the control for no more than six seconds until the zone selection number appears in the mirror display window. If a “C” appears repeat this step.
3. Release the COMP side of the control, then press it down again.

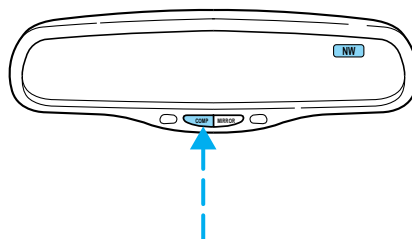

Controls and features

4. Continue to press until your zone number is shown in the mirror display, then release.
5. The display will show all segments, then return to normal compass mode within ten seconds.

Compass calibration adjustment

Perform this adjustment in an open area free from steel structures and high voltage lines.

1. Start the vehicle.
2. Press and hold the COMP side of the control for approximately six seconds until “C” appears in the mirror display.
3. Drive the vehicle slowly (less than 5 km/h [3 mph]) in circles or on your everyday routine until the display reads a direction.
4. The compass is now calibrated.

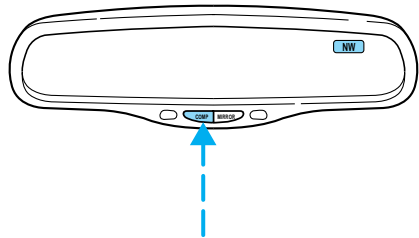

AUTOMATIC DIMMING REAR VIEW MIRROR

Your vehicle is equipped with inside and driver side outside rear view mirrors with an auto-dimming function. The electronic day/night mirrors will change from the normal state to the non-glare state when bright lights (glare) reach the mirrors. When the inside rear view mirror detects bright light from in front of or behind the vehicle, the inside and driver side outside rear view mirrors will automatically adjust (darken) to minimize glare.

Without moon roof:

Press the control to turn the mirror on or off.

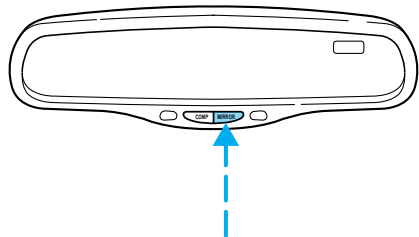

Controls and features

With moon roof:

Press the control to turn the mirror on or off.

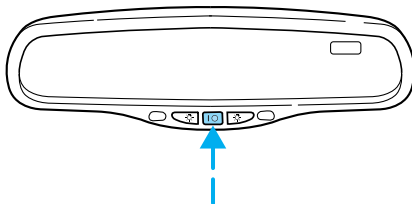

The mirror will automatically return to the normal state whenever the vehicle is placed in R (reverse)(when the mirror is on) to ensure a bright clear view when backing up.

Do not clean the housing or glass of any mirror with harsh abrasives, fuel or other petroleum-based cleaning products.

On vehicles equipped with a moonroof, the automatic rear view mirror has two map lamps. Refer to *Interior lamps* for more information.

POWER DOOR LOCKS

Press U to unlock all doors and L to lock all doors.

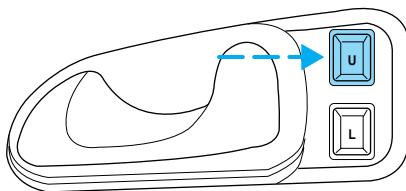

Smart locks

With the key in the ignition, in any switch position, and either the driver's or passenger's door open, the doors cannot be locked using the front door lock switches.

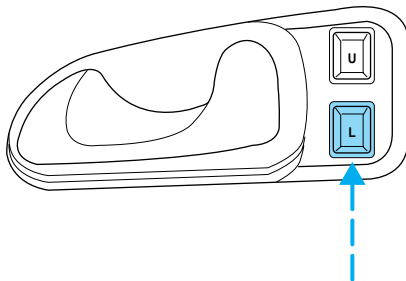

Controls and features

POWER WINDOWS

Press and pull the rocker switches to open and close windows.

- Press the top portion of the rocker switch to open.

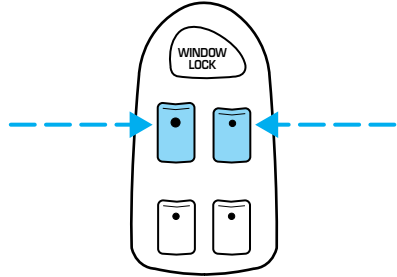

- Pull the top portion of the rocker switch to close.

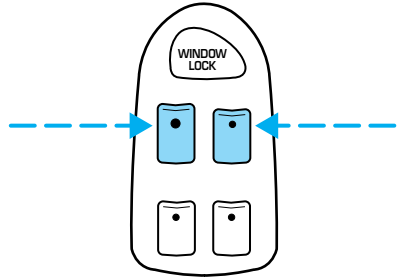

Express down

To make the driver window open fully without holding the window control, press and quickly release the driver window control. Press or pull the control to stop window operation.

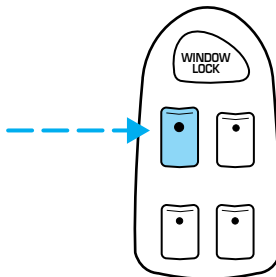

Controls and features

Window lock

The window lock feature allows only the driver to operate the power windows.

To lock out all the window controls except for the driver's press the control. Press the control again to restore the window controls.

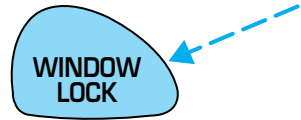

Accessory delay

With accessory delay, the window switches may be used for up to ten minutes after the ignition switch is turned to the OFF position or until any door is opened.

POWER SIDE VIEW MIRRORS

The ignition must be in ACC or ON position to adjust the power side view mirrors.

To adjust your mirrors:

1. Select L to adjust the left mirror or R to adjust the right mirror.

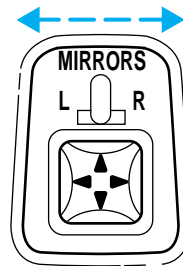

2. Move the control in the direction you wish to tilt the mirror.

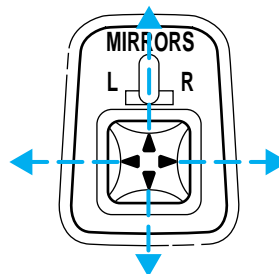

3. Return to the center position to lock mirrors in place.

Controls and features

Heated outside mirrors

Both mirrors are heated automatically to remove ice, mist and fog when the rear window defrost is activated.

Do not remove ice from the mirrors with a scraper or attempt to readjust the mirror glass if it is frozen in place. These actions could cause damage to the glass and mirrors.

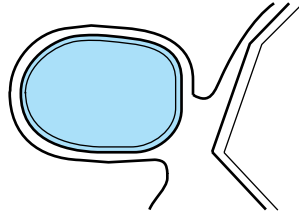

CHILDPROOF DOOR LOCKS

When these locks are set, the rear doors cannot be opened from the inside. The rear doors can be opened from the outside when the doors are unlocked.

The childproof locks are located on rear edge of each rear door and must be set separately for each door. Setting the lock for one door will not automatically set the lock for both doors.

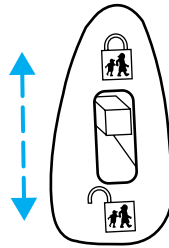

Move lock control up to engage the childproof lock. Move control down to disengage childproof locks.

TRUNK REMOTE CONTROL

The remote trunk release control is located on the driver's door trim panel and can be operated at any time.

You can render the switch inoperable by locking the button with your master key.

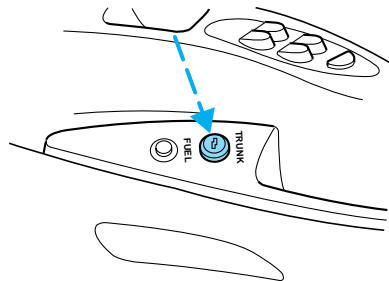

Controls and features

FUEL DOOR RELEASE

Your vehicle is equipped with a locking fuel door. To open the door, press the control located on the door.

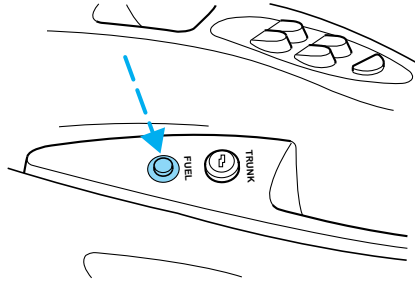

Fuel filler door override release

If the remote release is inoperative, open the trunk, then pull the override release handle located inside the trunk on the passenger side to open the fuel filler door.

CENTER CONSOLE (IF EQUIPPED)

Your vehicle is equipped with a variety of console features. These include:

- Utility compartment
- Cupholders
- Ashtray and lighter
- Compact disc changer (if equipped)
- Power point
- Coin holder
- Cellular phone (if equipped)

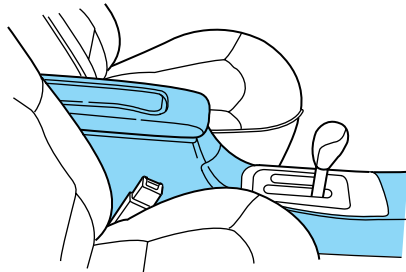

Use only soft cups in the cupholder. Hard objects can injure you in a collision.

Mini console (if equipped)

The mini console is available in the six passenger vehicle only, and consists of the:

Controls and features

- Cupholder
- Compact disc changer (if equipped)
- Ashtray and lighter

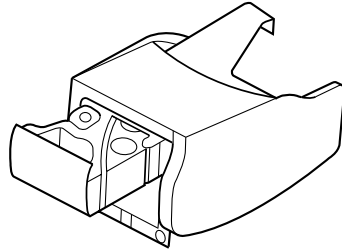

Use only soft cups in the cupholder. Hard objects can injure you in a collision.

POSITIVE RETENTION FLOOR MAT

Position the floor mat so that the eyelet is over the pointed end of the retention post and rotate forward to lock in. Make sure that the mat does not interfere with the operation of the accelerator or the brake pedal. To remove the floor mat, reverse the installation procedure.

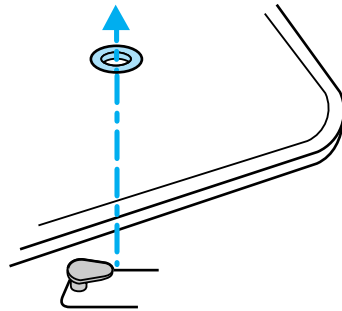

PERIMETER ALARM SYSTEM (IF EQUIPPED)

The perimeter anti-theft system will help prevent your vehicle from unauthorized entry.

If there is any potential perimeter anti-theft problem with your vehicle, ensure **ALL key fobs** (remote entry transmitters) are brought to the dealership, to aid in troubleshooting.

Arming the system

When armed, this system will help protect your vehicle from unauthorized entry. When unauthorized entry occurs, the system will flash the headlamps and/or parking lamps and the theft indicator lamp and will chirp the horn.

Controls and features

The system is ready to arm whenever the ignition is turned OFF. Any of the following actions will prearm the alarm system:

- Lock the doors with the remote transmitter (doors opened or closed). The horn will chirp to confirm that the control was pressed. The horn chirp feature can be turned on/off by using the feature menu in the message center.

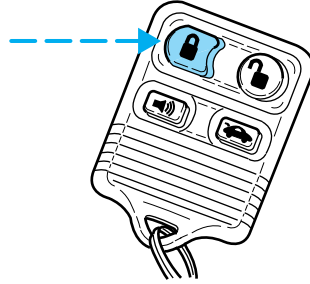

- Press 7/8 and 9/0 controls on the keyless entry pad at the same time to lock the doors (doors opened or closed).
- Open a door and press the power door lock control to lock the doors.

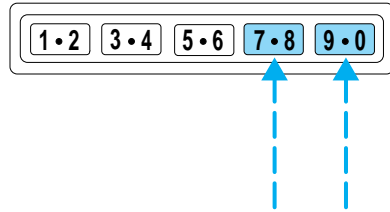

If a door is open, the system is prearmed and is waiting for the door to close. The anti-theft indicator on the instrument panel will be lit continuously when the system is prearmed.

Once the doors are closed, the system will arm in 30 seconds.

Disarming the system

You can disarm the system by any of the following actions:

- Unlock the doors by using your remote entry transmitter.

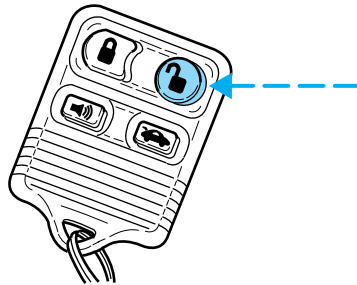

Controls and features

- Unlock the doors by using your keyless entry keypad.
- Unlock the doors with a key. Turn the key full travel (toward the front of the vehicle) to make sure the alarm disarms.
- Turn ignition to ACC or ON.

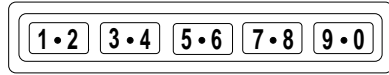

REMOTE ENTRY SYSTEM

The remote entry system allows you to lock or unlock all vehicle doors without a key.

The remote entry features only operate with the ignition in the OFF position.

If there is any potential remote keyless entry problem with your vehicle, ensure **ALL key fobs** (remote entry transmitters) are brought to the dealership, to aid in troubleshooting.

Unlocking the doors

Press this control to unlock the driver's door. The interior lamps will illuminate.

Press the control a second time within five seconds to unlock all doors.

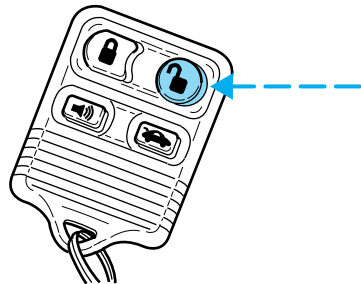

Locking the doors

Press this control to lock all doors.

The horn will chirp to confirm that the control was pressed. The horn chirp feature can be turned on/off by using the feature menu in the message center.

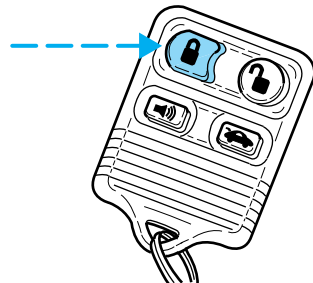

Controls and features

This process will arm your anti-theft system (if equipped). For more information on arming the anti-theft system, refer to *Perimeter alarm system* in this chapter.

Opening the trunk

Press the control once to open the trunk.

Ensure that the trunk is closed and latched before driving your vehicle. Failure to latch the trunk may cause objects to fall out of the trunk or block the rear view.

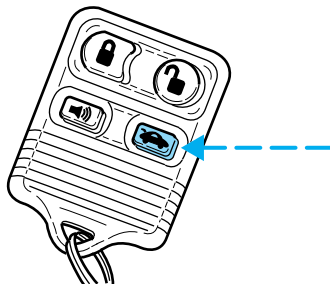

Sounding a panic alarm

Press this control to activate the alarm.

To deactivate the alarm, press the control again or turn the ignition to ACC or ON.

This device complies with part 15 of the FCC rules and with RS-210 of Industry Canada. Operation is subject to the following two conditions: (1) This device may not cause harmful interference, and (2) This device must accept any interference received, including interference that may cause undesired operation.

Changes or modifications not expressly approved by the party responsible for compliance could void the user's authority to operate the equipment.

Replacing the battery

The remote transmitter is powered by one coin type three-volt lithium battery CR2032 or equivalent. Typical operating range will allow you to be up to 10 meters (33 feet) away from your vehicle. A decrease in operating range can be caused by:

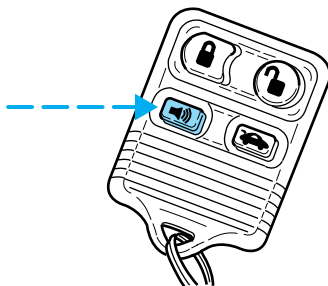

Controls and features

- weather conditions
- nearby radio towers
- structures around the vehicle
- other vehicles parked next to the vehicle

To replace the battery:

1. Twist a thin coin between the two halves of the transmitter near the key ring. **DO NOT TAKE THE FRONT PART OF THE TRANSMITTER APART.**

2. Place the positive (+) side of new battery in the same orientation. Refer to the diagram inside the transmitter unit.

3. Snap the two halves back together.

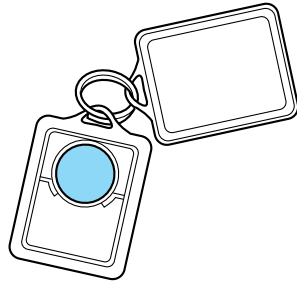

Replacement of the battery will **not** cause the remote transmitter to become deprogrammed from your vehicle. The remote transmitter should operate normally after battery replacement.

Replacing lost transmitters

Take all your vehicle's transmitters to your dealer if service is required.

If you purchase additional transmitters (up to four may be programmed into memory), perform the following procedure:

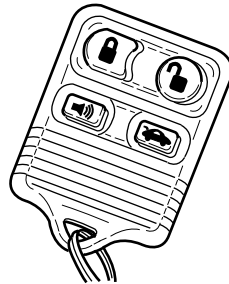

To reprogram the transmitters yourself, place the key in the ignition and turn from OFF to ON eight times in rapid succession (within 10 seconds) end in ON. After doors lock/unlock, press any control on all transmitters (up to four). With each control press of the transmitters, the door should cycle (lock/unlock) to confirm programming. When completed, turn the ignition to OFF. The door locks should cycle (lock/unlock) one last time and the horn will chirp to confirm completion of programming.

Controls and features

All transmitters **must** be reprogrammed at the same time.

Illuminated entry

The interior lamps illuminate when the remote entry system is used to unlock the door(s) or sound the personal alarm.

The system automatically turns off after 25 seconds or when the ignition is turned to the RUN or ACC position. The dome lamp control (if equipped) must **not** be set to the OFF position for the illuminated entry system to operate.

The inside lights will not turn off if:

- they have been turned on with the dimmer control or
- any door is open.

The battery saver will shut off the interior lamps 40 minutes after the ignition has been turned to the OFF position.

Memory seat/mirrors feature

The remote keyless entry system can also control the memory seats/mirrors feature. With this feature, the first two programmed transmitters will recall a different memory position.

Press the control once to unlock the driver's door and move the memory features to the corresponding memory position, just as if you had pressed the memory control in the vehicle.

- transmitter #1 will recall memory profile position #1.
- transmitter #2 will recall memory profile position #2.
- If a third or fourth transmitter is added, it will not recall a memory position.

Memory seat positions can be changed at any time. Transmitter #1 will always move the memory features to position #1.

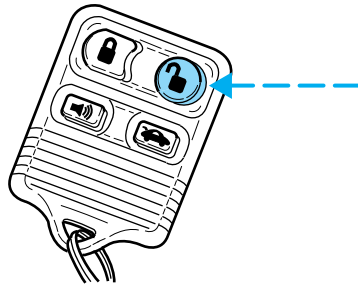

Controls and features

The system can be deactivated by switching the transmitter to OFF.

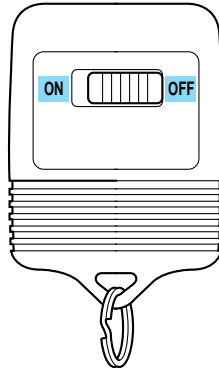

KEYLESS ENTRY SYSTEM

With the keyless entry keypad, you can:

- lock or unlock the vehicle doors without using the key.
- arm and disarm the perimeter alarm system (if equipped)
- reprogram remote entry transmitters.

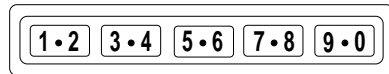

See also *Remote entry system* and *Perimeter alarm system* in this chapter for more information.

Your vehicle has a factory-set 5–digit code that operates the keyless entry system. You can also program your own 5–digit personal entry code.

The factory-set code is located:

- on the owner’s wallet card in the glove compartment
- taped to the computer module
- in the interior of the trunk

When pressing the controls on the keyless entry keypad, press the middle of the controls to ensure a good activation.

Controls and features

Programming your own entry code

1. Enter the factory-set code (keypad will illuminate when pressed).
2. Press the 1/2 control within five seconds of step 1.
3. Enter your personal 5–digit code. Enter each digit within five seconds of the previous one.
4. Enter a sixth digit to indicate which personality feature should be recalled by the personal code.
 - 1/2 recalls personality 1
 - 3/4 recalls personality 2
 - 9/0 does not recall a personality

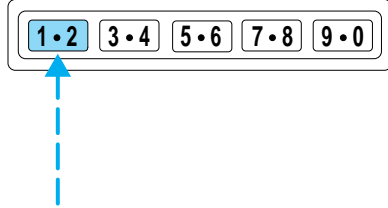

All of the vehicle doors will lock and unlock to confirm programming of the new code. Each personality driver profile (personality 1 or personality 2) can associated with only one personal code. The factory-set code cannot be associated with a personality code.

Do not set a code that includes five of the same number or presents them in sequential order. Thieves can easily figure out these types of codes.

You can program up to three personal codes to unlock your vehicle. These codes do not replace the permanent code that the dealership gave you.

Erasing personal code

To erase all of the personal entry codes programmed to a vehicle:

1. Enter the factory-set code.
2. Press 1/2 within 5 seconds of step 1.
3. Press and hold 1/2 for two seconds. All of the vehicle doors will lock and then unlock to confirm erasure.

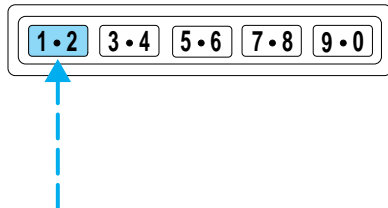

Controls and features

Unlocking the doors and releasing the trunk with the keyless entry system

To unlock the driver door, enter either the factory-set code or personal code (each digit pressed within 5 seconds of prior digit). The interior lamps will illuminate.

To unlock all doors, enter the factory-set code or personal code (driver door unlocks) and press 3/4 within five seconds.

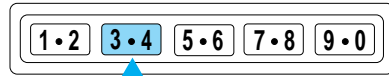

To release the trunk, enter the factory-set code or personal code (driver door unlocks) and press 5/6 within five seconds.

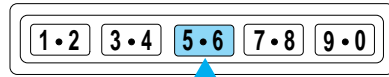

After the factory-set code or personal code has been entered, you can unlock all doors (press 3/4) and release the trunk (press 5/6) as long as the controls are pressed within five seconds of each other.

Locking doors with the keyless entry system

It is not necessary to enter the factory-set code prior to locking all doors. To lock the doors:

- Press 7/8 and 9/0 at the same time.

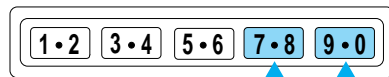

Controls and features

Autolock

The autolock feature will lock all of the doors when:

- all vehicle doors are fully closed
- the ignition key is turned to the ON position
- the vehicle is in a forward gear and
- you exceed 5 km/h (3 mph).

The autolock feature repeats when:

- the ignition key remains in the ON position
- a door is opened and then closed
- the vehicle is in a forward gear, and
- you exceed 5 km/h (3 mph).

The autolock feature can be turned on/off by using the feature menu in the message center. Refer to *Electronic message center* for more information.

SECURILOCK™ PASSIVE ANTI-THEFT SYSTEM

Your vehicle is equipped with a coded-key anti-theft system. Only the **correct key** will be able to start your vehicle. If your keys are lost or stolen, you must take your vehicle to your dealership for key reprogramming.

This system provides an advanced level of vehicle theft protection. Your vehicle's engine can only be started with the two coded keys provided with your vehicle. Each time you start your vehicle, the coded key is read by the anti-theft system. If the key identification code matches the code stored in the anti-theft system, the vehicle's engine is allowed to start. If the key identification code does not match the code stored in the system or if a coded key is not detected (vehicle theft situation), the vehicle's engine will not operate.

If there is any anti-theft problem with your vehicle, ensure **ALL coded keys** for that vehicle are brought to the dealership, to aid in troubleshooting.

The SecuriLock™ passive anti-theft system is not compatible with aftermarket remote start systems. Use of these systems may result in vehicle starting problems and a loss of security protection. Large metallic objects, electronic devices on the key chain that can be used to purchase gasoline or similar items, or a second key on the same key ring as the

Controls and features

PATS ignition key may cause vehicle starting concern and record DTC's under certain conditions. If present, you need to keep these objects from touching the PATS ignition key while starting the engine. These objects and devices cannot damage the PATS ignition key, but can cause a momentary concern if they are too close to the key during engine start. If a problem occurs, turn ignition OFF and restart the engine with all other objects on the key ring held away from the ignition key. Check to make sure the encoded ignition key is an approved Ford encoded ignition key.

Spare coded keys can be purchased from your dealership and programmed to your anti-theft system. Refer to *Programming spare SecuriLock™ keys* for more information.

If one or both of your coded keys are lost or stolen and you want to ensure the lost or stolen key will not operate your vehicle, bring your vehicle and all available coded keys to your dealership for reinitialization.

Theft indicator

The theft indicator on top of the dash will operate as follows:

- When the ignition is OFF, the theft indicator will flash briefly every two seconds to indicate the SecuriLock™ system is protecting your vehicle.
- When the ignition is turned to RUN or START, the theft indicator will light for three seconds and then go out. If the theft indicator stays on for an extended period of time or flashes rapidly, have the system serviced by your dealership or a qualified technician.

Programming spare SecuriLock™ keys

Spare SecuriLock™ keys can be purchased from your dealership and programmed to your SecuriLock™ passive anti-theft system (up to a total of eight keys). Your dealership can program your new SecuriLock™ key(s) to your vehicle or you can do it yourself using the following simple procedure. To program a new SecuriLock™ key yourself, you will need two previously programmed SecuriLock™ keys (keys that already operate your vehicle's engine). If two previously programmed SecuriLock™ keys are not available (one or both of your original keys were lost or stolen), you must bring your vehicle to your dealership to have the spare SecuriLock™ key(s) programmed.

Controls and features

Procedure to program spare SecuriLock™ keys to your vehicle

New SecuriLock™ keys must have the correct mechanical key cut for your vehicle.

Conventional (non-SecuriLock™) keys **cannot** be programmed to your vehicle.

You will need to have two previously programmed SecuriLock™ keys and the new unprogrammed SecuriLock™ key readily accessible for the procedure. Please read and understand the entire procedure before you begin.

1. Insert the first previously programmed SecuriLock™ key into the ignition and turn the ignition from OFF to ON (maintain ignition in ON for at least one second).
2. Turn ignition to OFF and remove the first SecuriLock™ key from the ignition.
3. Within five seconds of turning the ignition to OFF, insert the second previously programmed SecuriLock™ key into the ignition and turn the ignition from OFF to ON (maintain ignition in ON for at least one second but no more than five seconds).
4. Turn the ignition to OFF and remove the second SecuriLock™ key from the ignition.
5. Within 10 seconds of turning the ignition to OFF, insert the unprogrammed SecuriLock™ key (new key/valet key) into the ignition and turn the ignition from OFF to ON (maintain ignition in ON for at least one second). This step will program your new SecuriLock™ key.
6. To program additional SecuriLock™ key(s), repeat this procedure from step 1.

If the programming procedure was successful, the new SecuriLock™ key(s) will start the vehicle's engine. The theft indicator (located on the instrument cluster) will light for three seconds and then go out.

If the programming procedure was not successful, the new SecuriLock™ key(s) will not operate the vehicle's engine. The theft indicator will flash on and off. Wait at least one minute and then repeat the procedure from step 1. If failure repeats, bring your vehicle to your dealership to have the spare SecuriLock™ key(s) programmed.

Controls and features

INTERIOR LUGGAGE COMPARTMENT RELEASE (IF EQUIPPED)

Your vehicle is equipped with a mechanical interior luggage compartment release handle that provides a means of escape for children and adults in the event they become locked inside the luggage compartment.

Adults are advised to familiarize themselves with the operation and location of the release handle.

To open the luggage compartment door (lid) from the inside, pull the illuminated “T” shaped handle and push up on the trunk lid. The material that the handle is made of will glow for hours in the darkness of the luggage compartment following brief exposure to ambient light.

The “T” shaped handle will be located either on the luggage compartment door (lid) or inside the tail lamps.



Keep vehicle doors and luggage compartment locked and keep keys out of a child's reach. Unsupervised children could lock themselves in an open trunk and risk injury. Children should be taught not to play in vehicles.

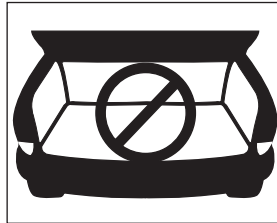

On hot days, the temperature in the trunk or vehicle interior can rise very quickly. Exposure of people or animals to these high temperatures for even a short time can cause death or serious heat-related injuries, including brain damage. Small children are particularly at risk.

Seating and safety restraints

SEATING

Adjustable head restraints

Your vehicle's seats may be equipped with head restraints which are vertically adjustable. The purpose of these head restraints is to help limit head motion in the event of a rear collision. To properly adjust your head restraints, lift the head restraint so that it is located directly behind your head or as close to that position as possible. Refer to the following to raise and lower the head restraints.

The head restraints can be moved up and down.

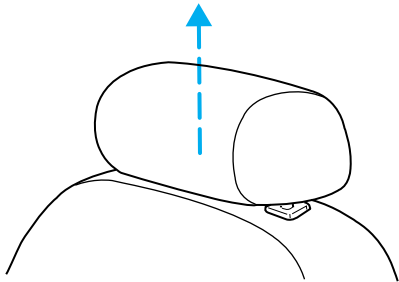

Push control to lower head restraint.

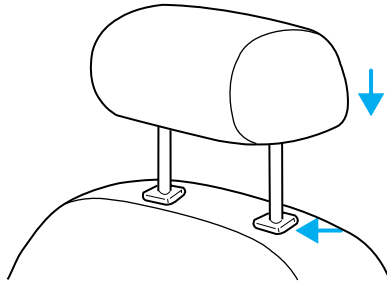

Adjusting the power front seats – door mounted controls

The controls for the power seats are located on the inside of each front door.



Never adjust the driver's seat or seatback when the vehicle is moving.

Seating and safety restraints



Do not pile cargo higher than the seatbacks to avoid injuring people in a collision or sudden stop.



Always drive and ride with your seatback upright and the lap belt snug and low across the hips.



Reclining the seatback can reduce the effectiveness of the seat's safety belt in the event of a collision.

Press the control to recline the seatback forward or backward.

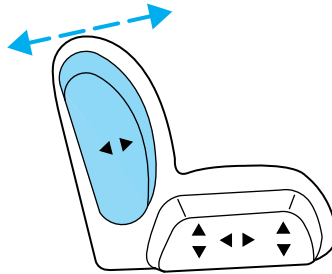

Press to move the seat forward or backward.

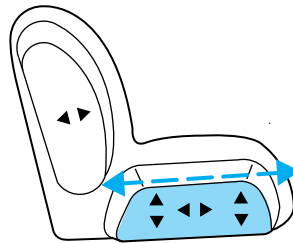

Press to move the front portion of the seat cushion up or down.

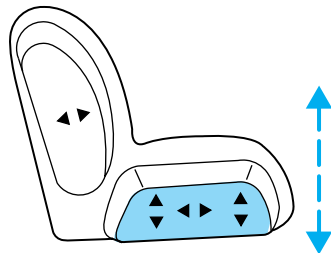

Seating and safety restraints

Press to move the rear portion of the seat cushion up or down.

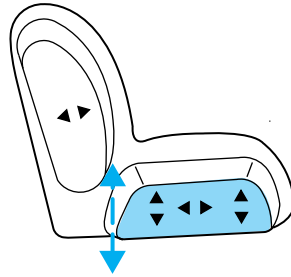

Heated seats (if equipped)

To operate the heated seats:

- Slide the control to **BACK** to heat the seatback only.
- Slide the control to **BOTH** to heat the seatback and the seat cushion.
- Rotate the thumbwheel to select the desired heat (from 0 (**OFF**) to 5 (**HI**)). Allow five minutes for the heat level to stabilize.

If the heated seat switch is not turned **OFF**, the seat will heat up to the selected temperature level each time the vehicle is started.

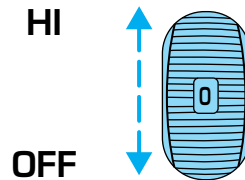
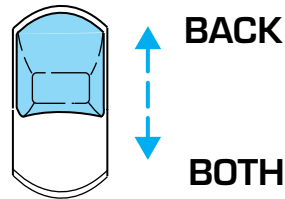

Using the power lumbar support

The power lumbar control is located on the outboard side of the seat.

Press one side of the control to adjust firmness.

Press the other side of the control to adjust softness.

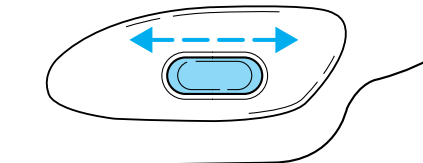

Seating and safety restraints

Easy access/easy out feature

This feature automatically moves the driver's seat backward when:

- the transmission is in N (Neutral) or P (Park)
- the key is removed from the ignition cylinder

The seat will move 5cm (2 inches) forward (to the original position) when:

- the transmission is in N (Neutral) or P (Park)
- the key is placed in the ignition cylinder

SAFETY RESTRAINTS

Safety restraints precautions



Always drive and ride with your seatback upright and the lap belt snug and low across the hips.



To reduce the risk of injury, make sure children sit where they can be properly restrained.



Never let a passenger hold a child on his or her lap while the vehicle is moving. The passenger cannot protect the child from injury in a collision.



All occupants of the vehicle, including the driver, should always properly wear their safety belts, even when an air bag SRS is provided.



It is extremely dangerous to ride in a cargo area, inside or outside of a vehicle. In a collision, people riding in these areas are more likely to be seriously injured or killed. Do not allow people to ride in any area of your vehicle that is not equipped with seats and safety belts. Be sure everyone in your vehicle is in a seat and using a safety belt properly.

Seating and safety restraints



In a rollover crash, an unbelted person is significantly more likely to die than a person wearing a seat belt.



Each seating position in your vehicle has a specific safety belt assembly which is made up of one buckle and one tongue that are designed to be used as a pair. 1) Use the shoulder belt on the outside shoulder only. Never wear the shoulder belt under the arm. 2) Never swing the safety belt around your neck over the inside shoulder. 3) Never use a single belt for more than one person.



Always transport children 12 years old and under in the back seat and always properly use appropriate child restraints.

Combination lap and shoulder belts

1. Insert the belt tongue into the proper buckle (the buckle closest to the direction the tongue is coming from) until you hear a snap and feel it latch. Make sure the tongue is securely fastened in the buckle.

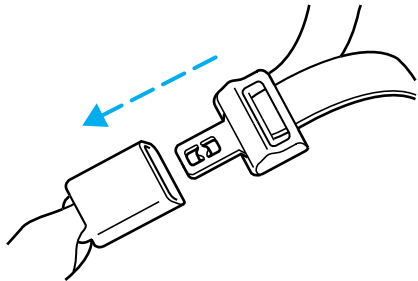

2. To unfasten, push the release button and remove the tongue from the buckle.

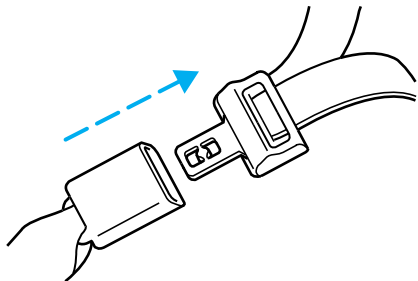

Seating and safety restraints

The front outboard and rear safety restraints in the vehicle are combination lap and shoulder belts. The front passenger and rear seat safety belts have two types of locking modes described below:

Vehicle sensitive mode

The vehicle sensitive mode is the normal retractor mode, allowing free shoulder belt length adjustment to your movements and locking in response to vehicle movement. For example, if the driver brakes suddenly or turns a corner sharply, or the vehicle receives an impact of approximately 8 km/h (5 mph) or more, the combination safety belts will lock to help reduce forward movement of the driver and passengers.

Automatic locking mode

In this mode, the shoulder belt is automatically pre-locked. The belt will still retract to remove any slack in the shoulder belt.

The automatic locking mode is not available on the driver safety belt.

When to use the automatic locking mode

- **Anytime** a child safety seat is installed in the vehicle. Children 12 years old and under should be properly restrained in the rear seat whenever possible. Refer to *Safety Restraints for Children* or *Safety Seats for Children* later in this chapter.

How to use the automatic locking mode

- Buckle the combination lap and shoulder belt.

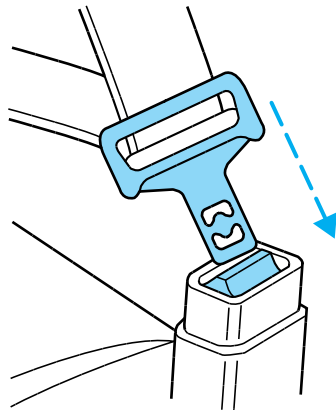

Seating and safety restraints

- Grasp the shoulder portion and pull downward until the entire belt is extracted.



- Allow the belt to retract. As the belt retracts, you will hear a clicking sound. This indicates the safety belt is now in the automatic locking mode.

How to disengage the automatic locking mode

Disconnect the combination lap/shoulder belt and allow it to retract completely to disengage the automatic locking mode and activate the vehicle sensitive (emergency) locking mode.

Front safety belt height adjustment

Your vehicle has safety belt height adjustments for the driver and front passenger. Adjust the height of the shoulder belt so the belt rests across the middle of your shoulder.

To lower the shoulder belt height, push the button and slide the height adjuster down. To raise the height of the shoulder belt, slide the height adjuster up. Pull down on the height adjuster to make sure it is locked in place.

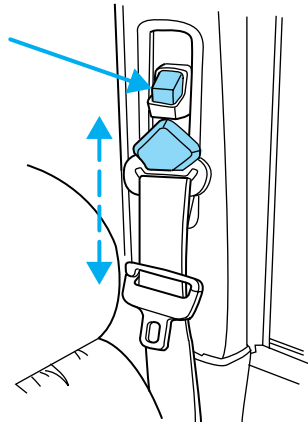

Seating and safety restraints



Position the shoulder belt height adjusters so that the belt rests across the middle of your shoulder. Failure to adjust the safety belt properly could reduce the effectiveness of the seat belt and increase the risk of injury in a collision.

Lap belts

Adjusting the front center seat lap belt (if equipped)

The lap belt does not adjust automatically. Adjust to fit snugly and as low as possible around your hips. Do not wear the lap belt around your waist.

Insert the tongue into the correct buckle (the buckle closest to the direction the tongue is coming from). To lengthen the belt, turn the tongue at a right angle to the belt and pull across your lap until it reaches the buckle. To tighten the belt, pull the loose end of the belt through the tongue until it fits snugly across the hips.

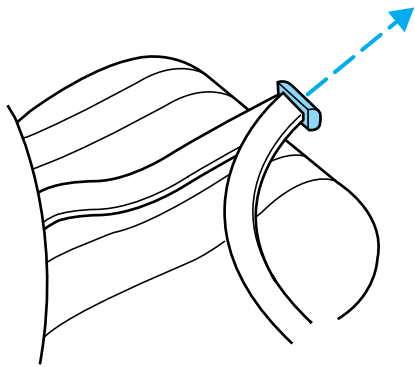

Shorten and fasten the belt when not in use.

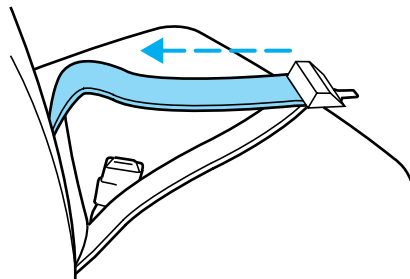

Safety belt extension assembly

If the safety belt assembly is too short, even when fully extended, 20 cm (8 inches) can be added to the safety belt assembly by adding a safety belt extension assembly (part number 611C22). Safety belt extension assemblies can be obtained from your dealer at no cost.

Seating and safety restraints

Use only extensions manufactured by the same supplier as the safety belt. Manufacturer identification is located at the end of the webbing on the label. Also, use the safety belt extension only if the safety belt is too short for you when fully extended. Do not use extensions to change the fit of the shoulder belt across the torso.

Safety belt warning light and indicator chime

The seat belt warning light illuminates in the instrument cluster and a chime sounds to remind the occupants to fasten their safety belts.

Conditions of operation

If...	Then...
The driver's safety belt is not buckled before the ignition switch is turned to the ON position...	The safety belt warning light illuminates 1-2 minutes and the warning chime sounds 4-8 seconds.
The driver's safety belt is buckled while the indicator light is illuminated and the warning chime is sounding...	The safety belt warning light and warning chime turn off.
The driver's safety belt is buckled before the ignition switch is turned to the ON position...	The safety belt warning light and indicator chime remain off.

Belt minder (if equipped)

The Belt Minder feature is a supplemental warning to the safety belt warning function. This feature provides additional reminders to the driver that the driver's safety belt is unbuckled by intermittently sounding a chime and illuminating the safety belt warning lamp in the instrument cluster.

Seating and safety restraints

If...	Then...
The driver's safety belt is not buckled before the vehicle has reached at least 5 km/h (3 mph) and 1-2 minutes have elapsed since the ignition switch has been turned to ON...	The Belt Minder feature is activated - the safety belt warning light illuminates and the warning chime sounds for 6 seconds every 30 seconds, repeating for approximately 5 minutes or until safety belt is buckled.
The driver's safety belt is buckled while the safety belt indicator light is illuminated and the safety belt warning chime is sounding...	The Belt Minder feature will not activate.
The driver's safety belt is buckled before the ignition switch is turned to the ON position...	The Belt Minder feature will not activate.

The purpose of the Belt Minder is to remind occasional wearers to wear safety belts all of the time.

The following are reasons most often given for not wearing safety belts: (All statistics based on U.S. data)

Reasons given...	Consider...
"Crashes are rare events"	36 700 crashes occur every day. The more we drive, the more we are exposed to "rare" events, even for good drivers. <i>1 in 4 of us will be seriously injured in a crash during our lifetime.</i>
"I'm not going far"	3 of 4 fatal crashes occur within 25 miles of home.
"Belts are uncomfortable"	Ford designs its safety belts to enhance comfort. If you are uncomfortable - try different positions for the safety belt upper anchorage and seatback which should be as upright as possible; this can improve comfort.
"I was in a hurry"	Prime time for an accident. Belt Minder reminds us to take a few seconds to buckle up.
"Seat belts don't work"	Safety belts , when used properly, reduce risk of death to front seat occupants by 45% in cars , and by 60% in light trucks .

Seating and safety restraints

Reasons given...	Consider...
"Traffic is light"	Nearly 1 of 2 deaths occur in single-vehicle crashes , many when no other vehicles are around.
"Belts wrinkle my clothes"	Possibly, but a serious crash can do much more than wrinkle your clothes, particularly if you are unbelted.
"The people I'm with don't wear belts"	Set the example, teen deaths occur 4 times more often in vehicles with TWO or MORE people. Children and younger brothers/sisters imitate behavior they see.
"I have an air bag"	Air bags offer greater protection when used with safety belts. Frontal airbags are not designed to inflate in rear and side crashes or rollovers.
"I'd rather be thrown clear"	Not a good idea, people who are ejected are 40 times more likely to DIE . Safety belts help prevent ejection, WE CAN'T "PICK OUR CRASH".



Do not sit on top of a buckled safety belt to avoid the Belt Minder chime. Sitting on the safety belt will increase risk of injury in an accident. To disable (one time) or deactivate the Belt Minder feature please follow the directions stated below.

One time disable

Anytime the safety belt is buckled and then unbuckled during an ignition ON cycle, Belt Minder will be disabled for that ignition cycle only.

Deactivating/activating the belt minder feature

Read steps 1 - 9 thoroughly before proceeding with the deactivation/activation programming procedure.

The Belt Minder feature can be deactivated/activated by performing the following procedure:

Before following the procedure, make sure that:

- the parking brake is set
- the gearshift is in P (Park) (automatic transmission).
- the ignition switch is in the OFF position

Seating and safety restraints

- all vehicle doors are closed
- the driver's safety belt is unbuckled
- the parklamps/headlamps are in OFF position (If vehicle is equipped with Autolamps, this will not affect the procedure.)



To reduce the risk of injury, do not deactivate/activate the Belt Minder feature while driving the vehicle.

1. Turn the ignition switch to the RUN (or ON) position. (DO NOT START THE ENGINE)
2. Wait until the safety belt warning light turns off. (Approximately 1–2 minutes)
 - Steps 3–5 must be completed within 60 seconds or the procedure will have to be repeated.
3. Buckle then unbuckle the safety belt three times, ending with the safety belt unbuckled. This can be done before or during Belt Minder warning activation.
4. Turn on the parklamps/headlamps, turn off the parklamps/headlamps.
5. Buckle then unbuckle the safety belt three times, ending with the safety belt unbuckled.
 - After step 5 the safety belt warning light will be turned on for three seconds.
6. Within seven seconds of the safety belt warning light turning off, buckle then unbuckle the safety belt.
 - This will disable Belt Minder if it is currently enabled, or enable Belt Minder if it is currently disabled.
7. Confirmation of disabling Belt Minder is provided by flashing the safety belt warning light four times per second for three seconds.
8. Confirmation of enabling Belt Minder is provided by flashing the safety belt warning light four times per second for three seconds, followed by three seconds with the safety belt warning light off, then followed by flashing the safety belt warning light four times per second for three seconds again.
9. After receiving confirmation, the deactivation/activation procedure is complete.

Seating and safety restraints

Safety belt maintenance

Inspect the safety belt systems periodically to make sure they work properly and are not damaged. Inspect the safety belts to make sure there are no nicks, wears or cuts, replacing if necessary. All safety belt assemblies, including retractors, buckles, front seat belt buckle assemblies, buckle support assemblies (slide bar-if equipped), shoulder belt height adjusters (if equipped), shoulder belt guide on seatback (if equipped), child safety seat tether bracket assemblies (if equipped), and attaching hardware, should be inspected after a collision. Ford recommends that all safety belt assemblies used in vehicles involved in a collision be replaced. However, if the collision was minor and a qualified technician finds that the belts do not show damage and continue to operate properly, they do not need to be replaced. Safety belt assemblies not in use during a collision should also be inspected and replaced if either damage or improper operation is noted.



Failure to inspect and if necessary replace the safety belt assembly under the above conditions could result in severe personal injuries in the event of a collision.

Refer to *Cleaning and maintaining the safety belts* in the *Maintenance and care* section.

AIR BAG SUPPLEMENTAL RESTRAINT SYSTEM (SRS)

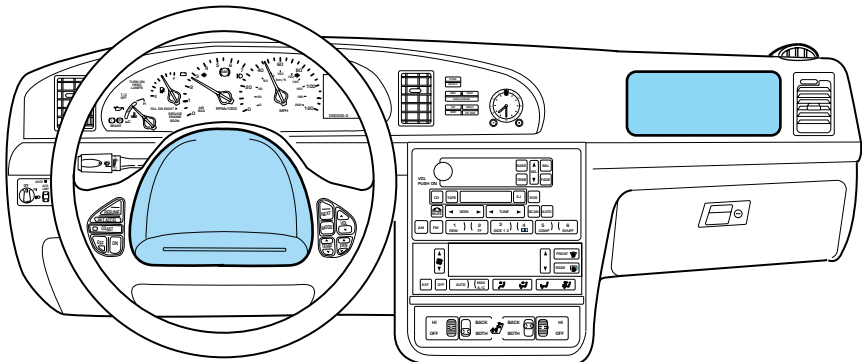

Your vehicle is equipped with a crash sensing and diagnostic module which records information about the air bag and sensor systems. In the event of a collision this module may save information related to the

Seating and safety restraints

collision including information about the air bag system and impact severity. This information will assist Ford in the servicing of your vehicle and may help Ford better understand real world collisions and further improve the safety of future vehicles.

Important supplemental restraint system (SRS) precautions

The supplemental restraint system is designed to work with the safety belt to help protect the driver and right front passenger from certain upper body injuries.

Air bags DO NOT inflate slowly or gently and the risk of injury from a deploying air bag is greatest close to the trim covering the air bag module.

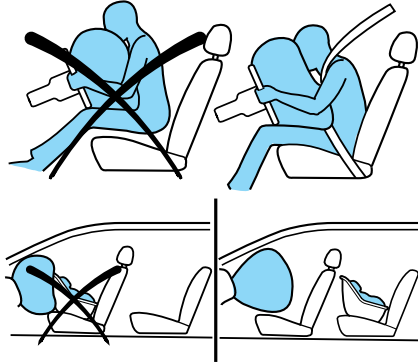

All occupants of the vehicle, including the driver, should always properly wear their safety belts, even when an air bag SRS is provided.



Always transport children 12 years old and under in the back seat and always properly use appropriate child restraints.



National Highway Traffic Safety Administration (NHTSA) recommends a minimum distance of at least 25 cm (10 inches) between an occupant's chest and the driver air bag module.



Never place your arm over the air bag module as a deploying air bag can result in serious arm fractures or other injuries.

Steps you can take to properly position yourself away from the air bag:

- Move your seat to the rear as far as you can while still reaching the pedals comfortably.

Seating and safety restraints

- Recline the seat slightly (one or two degrees) from the upright position.



Do not put anything on or over the air bag module. Placing objects on or over the air bag inflation area may cause those objects to be propelled by the air bag into your face and torso causing serious injury.



Do not attempt to service, repair, or modify the Air Bag Supplemental Restraint System or its fuses. See your Ford or Lincoln-Mercury dealer.



Modifications to the front end of the vehicle, including frame, bumper, front end body structure and tow hooks may effect the performance of the air bag sensors increasing the risk of injury. Do not modify the front end of the vehicle.

Children and air bags

For additional important safety information, read all information on safety restraints in this guide.

Children must always be properly restrained. Accident statistics suggest that children are safer when properly restrained in the rear seating positions than in the front seating position. Failure to follow these instructions may increase the risk of injury in a collision.



Air bags can kill or injure a child in a child seat. **NEVER** place a rear-facing child seat in front of an active air bag. If you must use a forward-facing child seat in the front seat, move the seat all the way back.

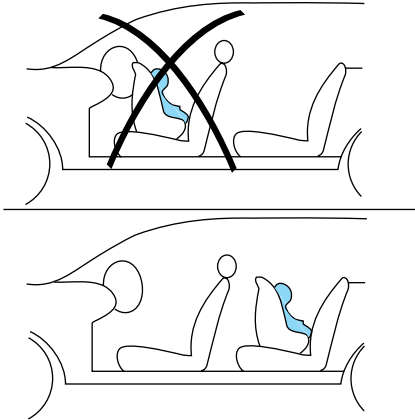

Seating and safety restraints

How does the air bag supplemental restraint system work?

The air bag SRS is designed to activate when the vehicle sustains longitudinal deceleration sufficient to cause the sensors to close an electrical circuit that initiates air bag inflation.

The fact that the air bags did not inflate in a collision does not mean that something is wrong with the system. Rather, it means the forces were not of the type sufficient to cause activation. Air bags are designed to inflate in frontal and near-frontal collisions, not rollover, side-impact, or rear-impacts unless the collision causes sufficient longitudinal deceleration.

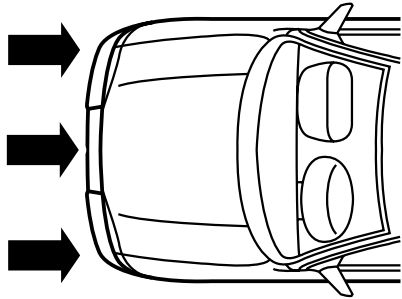

The air bags inflate and deflate rapidly upon activation. After air bag deployment, it is normal to notice a smoke-like, powdery residue or smell the burnt propellant. This may consist of cornstarch, talcum powder (to lubricate the bag) or sodium compounds (e.g., baking soda) that result from the combustion process that inflates the air bag. Small amounts of sodium hydroxide may be present which may irritate the skin and eyes, but none of the residue is toxic.



While the system is designed to help reduce serious injuries, contact with a deploying air bag may also cause abrasions, swelling or temporary hearing loss. Because air bags must inflate rapidly and with considerable force, there is the risk of death or serious injuries such as fractures, facial and eye injuries or internal injuries, particularly to occupants who are not properly restrained or are otherwise out of position at the time of air bag deployment. Thus, it is extremely important that occupants be properly restrained as far away from the air bag module as possible while maintaining vehicle control.

Seating and safety restraints



Several air bag system components get hot after inflation. Do not touch them after inflation.



If the air bag is inflated, **the air bag will not function again and must be replaced immediately.** If the air bag is not replaced, the unrepaired area will increase the risk of injury in a collision.

The SRS consists of:

- driver and passenger air bag modules (which include the inflators and air bags),
- one or more impact and safing sensors,
- a readiness light and tone
- and the electrical wiring which connects the components.

The diagnostic module monitors its own internal circuits and the supplemental air bag electrical system warning (including the impact sensors), the system wiring, the air bag system readiness light, the air bag back up power and the air bag igniters.

Determining if the system is operational

The SRS uses a readiness light in the instrument cluster or a tone to indicate the condition of the system. Refer to the *Air bag readiness* section in the *Instrumentation* chapter. Routine maintenance of the air bag is not required.

A difficulty with the system is indicated by one or more of the following:

- The readiness light will either flash or stay lit.
- The readiness light will not illuminate immediately after ignition is turned on.
- A series of five beeps will be heard. The tone pattern will repeat periodically until the problem and light are repaired.

**AIR
BAG**

If any of these things happen, even intermittently, have the SRS serviced at your dealership or by a qualified technician immediately. Unless serviced, the system may not function properly in the event of a collision.

Seating and safety restraints

Side air bag system (if equipped)



Do not place objects or mount equipment on or near the air bag cover on the side of the seatbacks of the front seats or in front seat areas that may come into contact with a deploying air bag. Failure to follow these instructions may increase the risk of personal injury in the event of a collision.



Do not use accessory seat covers. The use of accessory seat covers may prevent the deployment of the side air bags and increase the risk of injury in an accident.



Do not lean your head on the door. The side air bag could injure you as it deploys from the side of the seatback.



Do not attempt to service, repair, or modify the air bag Supplemental Restraint System, its fuses or the seat cover on a seat containing an air bag. See your Ford or Lincoln Mercury dealer.



All occupants of the vehicle including the driver should always wear their safety belts even when an air bag SRS is provided.

Seating and safety restraints

How does the side air bag system work?

The side air bag system consists of the following:

- An inflatable nylon bag (air bag) with a gas generator concealed behind the outboard bolster of the driver and front passenger seatbacks.
- A special seat cover designed to allow airbag deployment.
- The same warning light, electronic control and diagnostic unit as used for the front air bags.
- Two crash sensors located under the outboard side of the front seats, attached to the floor.

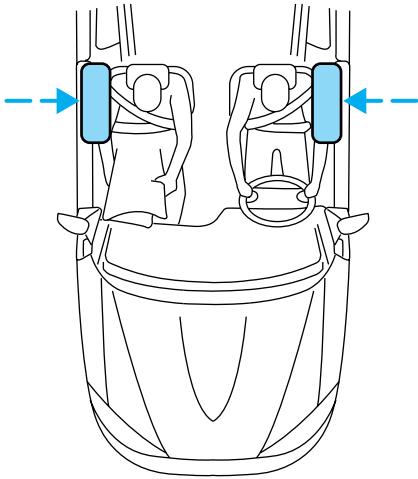

Side air bags, in combination with seat belts, can help reduce the risk of severe injuries in the event of a significant side impact collision.

The side air bags are fitted on the outboard side of the seatbacks of the front seats. In certain lateral collisions, the air bag on the side affected by the collision will be inflated, even if the respective seat is not occupied. The air bag was designed to inflate between the door panel and occupant to further enhance the protection provided occupants in side impact collisions.

The air bag SRS is designed to activate when the vehicle sustains lateral deceleration sufficient to cause the sensors to close an electrical circuit that initiates air bag inflation.

The fact that the air bags did not inflate in a collision does not mean that something is wrong with the system. Rather, it means the forces were not of the type sufficient to cause activation. Side air bags are designed to inflate in side-impact collisions, not roll-over, rear-impact, frontal or near-frontal collisions, unless the collision causes sufficient lateral deceleration.

Seating and safety restraints



Several air bag system components get hot after inflation. Do not touch them after inflation.



If the side air bag has deployed, **the air bag will not function again. The side air bag system (including the seat) must be inspected and serviced by a qualified technician in accordance with the vehicle service manual.** If the air bag is not replaced, the unrepaired area will increase the risk of injury in a collision.

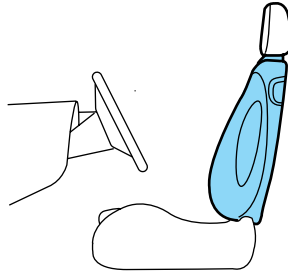

Determining if the system is operational

The SRS uses a readiness light in the instrument cluster or a tone to indicate the condition of the system. Refer to the *Air bag readiness* section in the *Instrumentation* chapter. Routine maintenance of the air bag is not required.

A difficulty with the system is indicated by one or more of the following:

- The readiness light (same light as for front air bag system) will either flash or stay lit.
- The readiness light will not illuminate immediately after ignition is turned on.
- A series of five beeps will be heard. The tone pattern will repeat periodically until the problem and light are repaired.

If any of these things happen, even intermittently, have the SRS serviced at your dealership or by a qualified technician immediately. Unless serviced, the system may not function properly in the event of a collision.

Seating and safety restraints

Disposal of air bags and air bag equipped vehicles (including pretensioners)

For disposal of air bags or air bag equipped vehicles, see your local dealership or qualified technician. Air bags **MUST BE** disposed of by qualified personnel.

SAFETY RESTRAINTS FOR CHILDREN

See the following sections for directions on how to properly use safety restraints for children. Also see *Air Bag Supplemental Restraint System (SRS)* in this chapter for special instructions about using air bags.

Important child restraint precautions

You are required by law to use safety restraints for children in the U.S. and Canada. If small children ride in your vehicle (generally children who are four years old or younger and who weigh 18 kg [40 lbs] or less), you must put them in safety seats made especially for children. Check your local and state or provincial laws for specific requirements regarding the safety of children in your vehicle.



Never let a passenger hold a child on his or her lap while the vehicle is moving. The passenger cannot protect the child from injury in a collision.

Always follow the instructions and warnings that come with any infant or child restraint you might use.

When possible, always place children under age 12 in the rear seat of your vehicle. Accident statistics suggest that children are safer when properly restrained in the rear seating positions than in the front seating position.

Children and safety belts

If the child is the proper size, restrain the child in a safety seat.

Children who are too large for child safety seats (as specified by your child safety seat manufacturer) should always wear safety belts.

Follow all the important safety restraint and air bag precautions that apply to adult passengers in your vehicle.

If the shoulder belt portion of a combination lap and shoulder belt can be positioned so it does not cross or rest in front of the child's face or

Seating and safety restraints

neck, the child should wear the lap and shoulder belt. Moving the child closer to the center of the vehicle may help provide a good shoulder belt fit.



Do not leave children, unreliable adults, or pets unattended in your vehicle.

To improve the fit of lap and shoulder belts on children who have outgrown child safety seats, Ford recommends use of a belt-positioning booster seat that is labelled as conforming to all Federal motor vehicle safety standards. Belt-positioning booster seats raise the child and provide a shorter, firmer seating cushion that encourages safer seating posture and better fit of lap and shoulder belts on the child.

A belt-positioning booster should be used if the shoulder belt rests in front of the child's face or neck, or if the lap belt does not fit snugly on both thighs, or if the thighs are too short to let the child sit all the way back on the seat cushion when the lower legs hang over the edge of the seat cushion. You may wish to discuss the special needs of your child with your pediatrician.

SAFETY SEATS FOR CHILDREN



Child and infant or child safety seats

Use a safety seat that is recommended for the size and weight of the child. Carefully follow all of the manufacturer's instructions with the safety seat you put in your vehicle. If you do not install and use the safety seat properly, the child may be injured in a sudden stop or collision.

Seating and safety restraints

When installing a child safety seat:

- Review and follow the information presented in the *Air Bag Supplemental Restraint System* section in this chapter.
- Use the correct safety belt buckle for that seating position.
- Insert the belt tongue into the proper buckle until you hear a snap and feel it latch. Make sure the tongue is securely fastened in the buckle.
- Keep the buckle release button pointing up and away from the safety seat, with the tongue between the child seat and the release button, to prevent accidental unbuckling.
- Place seat back in upright position.
- Put the safety belt in the automatic locking mode. Refer to *Automatic locking mode*.

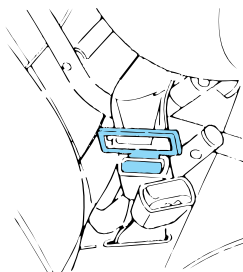

Ford recommends the use of a child safety seat having a top tether strap. Install the child safety seat in a seating position which is capable of providing a tether anchorage. For more information on top tether straps, refer to *Attaching safety seats with tether straps*.



Carefully follow all of the manufacturer's instructions included with the safety seat you put in your vehicle. If you do not install and use the safety seat properly, the child may be injured in a sudden stop or collision.

Seating and safety restraints

Installing child safety seats in combination lap and shoulder belt seating positions

1. Position the child safety seat in a seat with a combination lap and shoulder belt.

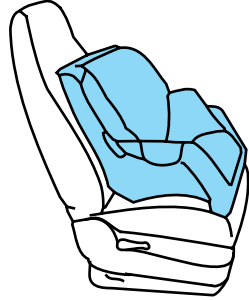

An air bag can kill or injure a child in a child seat. If you must use a forward-facing child seat in the front seat, move seat all the way back.



Children 12 and under should be properly restrained in the rear seat whenever possible.

2. Pull down on the shoulder belt and then grasp the shoulder belt and lap belt together.

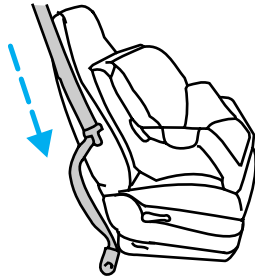

Seating and safety restraints

3. While holding the shoulder and lap belt portions together, route the tongue through the child seat according to the child seat manufacturer's instructions. Be sure the belt webbing is not twisted.

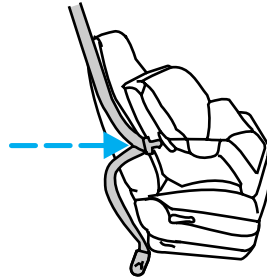

4. Insert the belt tongue into the proper buckle (the buckle closest to the direction the tongue is coming from) for that seating position until you hear a snap and feel the latch engage. Make sure the tongue is latched securely by pulling on it.

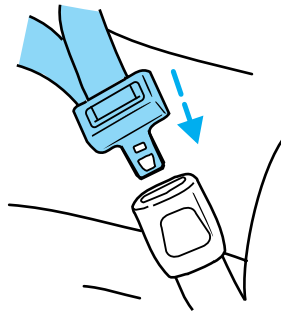

5. To put the retractor in the automatic locking mode, grasp the shoulder portion of the belt and pull downward until all of the belt is extracted and a click is heard.

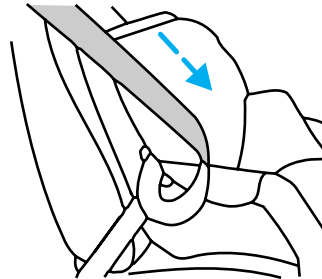

6. Allow the belt to retract. The belt will click as it retracts to indicate it is in the automatic locking mode.

Seating and safety restraints

7. Pull the lap belt portion across the child seat toward the buckle and pull up on the shoulder belt while pushing down with your knee on the child seat.

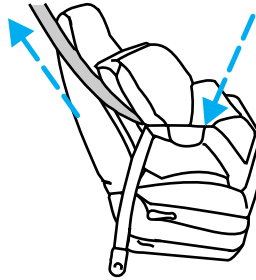

8. Allow the safety belt to retract to remove any slack in the belt.

9. Before placing the child in the seat, forcibly tilt the seat forward and back to make sure the seat is securely held in place.

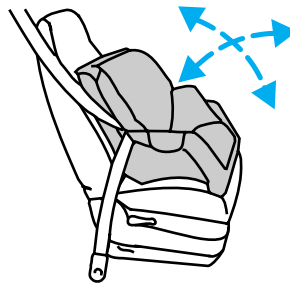

10. Try to pull the belt out of the retractor to make sure the retractor is in the automatic locking mode (you should not be able to pull more belt out). If the retractor is not locked, unbuckle the belt and repeat steps two through nine.

Check to make sure the child seat is properly secured before each use.

Attaching child safety seats with tether straps

Most new forward-facing child safety seats include a tether strap which goes over the back of the seat and hooks to an anchoring point. Tether straps are available as an accessory for many older safety seats. Contact the manufacturer of your child seat for information about ordering a tether strap.

The rear seats of your vehicle are equipped with built-in tether strap anchors located behind the seats as described below.

The tether anchors in your vehicle are either located under a cover marked with the tether anchor symbol (shown with title) or are recessed bars on the back side of the seatback.

Seating and safety restraints

The tether strap anchors in your vehicle are in the following positions (shown from top view):

 Attach the tether strap only to the appropriate tether anchor as shown. The tether strap may not work properly if attached somewhere other than the correct tether anchor.

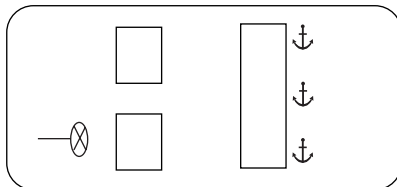

1. Position the child safety seat on the passenger seat cushion.
2. Route the child safety seat tether strap over the back of the seat.

For vehicles with adjustable head restraints, route the tether strap under the head restraint and between the head restraint posts, otherwise route the tether strap over the top of the seatback.

3. Locate the correct anchor for the selected seating position.



4. Open the tether anchor cover.

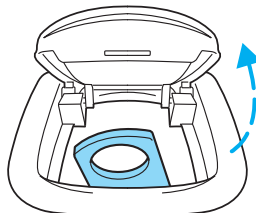

5. Clip the tether strap to the anchor as shown.

 If the tether strap is clipped incorrectly, the child safety seat may not be retained properly in the event of a collision.

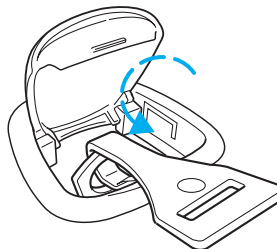

Seating and safety restraints

6. Refer to the *Installing child safety seats in combination lap and shoulder belt seating positions* section of this chapter for further instructions to secure the child safety seat.
7. Tighten the child safety seat tether strap according to the manufacturer's instructions.



If the safety seat is not anchored properly, the risk of a child being injured in a collision greatly increases.

Starting

PREPARING TO START YOUR VEHICLE

Engine starting is controlled by the powertrain control system. This system meets all Canadian Interference-Causing Equipment standard requirements regulating the impulse electrical field strength of radio noise.

When starting a fuel-injected engine, avoid pressing the accelerator before or during starting. Only use the accelerator when you have difficulty starting the engine. For more information on starting the vehicle, refer to *Starting the engine* in this chapter.



Extended idling at high engine speeds can produce very high temperatures in the engine and exhaust system, creating the risk of fire or other damage.



Do not park, idle, or drive your vehicle in dry grass or other dry ground cover. The emission system heats up the engine compartment and exhaust system, which can start a fire.



Do not start your vehicle in a closed garage or in other enclosed areas. Exhaust fumes can be toxic. Always open the garage door before you start the engine. See *Guarding against exhaust fumes* in this chapter for more instructions.



If you smell exhaust fumes inside your vehicle, have your dealer inspect your vehicle immediately. Do not drive if you smell exhaust fumes.

Important safety precautions

A computer system controls the engine's idle revolutions per minute (RPM). When the engine starts, the idle RPM runs faster to warm the engine. If the engine idle speed does not slow down automatically, have the vehicle checked. Do not allow the vehicle to idle for more than 10 minutes at the higher engine RPM.

Before starting the vehicle:

1. Make sure all vehicle occupants have buckled their safety belts. For more information on safety belts and their proper usage, refer to the *Seating and safety restraints* chapter.

Starting

2. Make sure the headlamps and vehicle accessories are off.

- Make sure the parking brake is set.

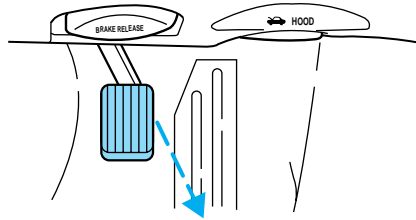

- Make sure the gearshift is in P (Park).

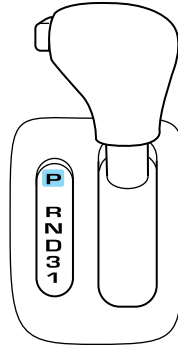
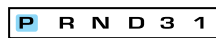

3. Turn the key to 4 (ON) without turning the key to 5 (START).

If there is difficulty in turning the key, firmly rotate the steering wheel left and right until the key turns freely. This condition may occur when:

- front wheels are turned
- front wheel is against the curb
- steering wheel is turned when getting in or out of the vehicle

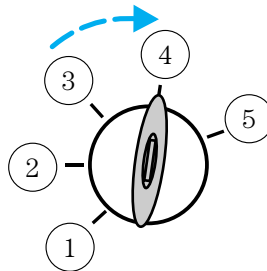

Starting

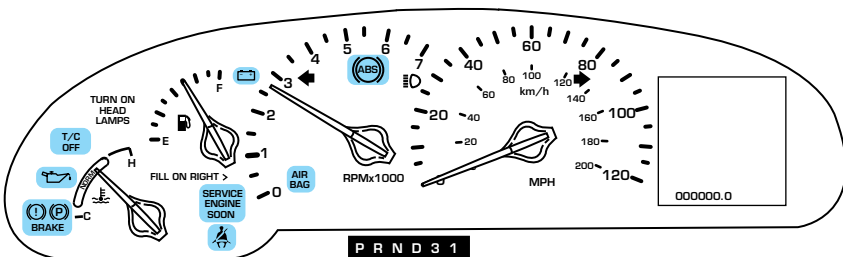

Make sure the corresponding lights illuminate briefly. If a light fails to illuminate, have the vehicle serviced.

- If the driver's safety belt is fastened, the  light may not illuminate.

STARTING THE ENGINE

1. Turn the key to 5 (START) without pressing the accelerator pedal and release as soon as the engine starts. The key will return to 4 (ON).
2. If the temperature is above -12°C (10°F) and the engine does not start within five seconds on the first try, turn the key to OFF, wait 10 seconds and try again.

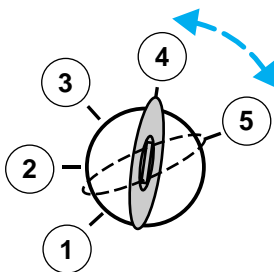

3. If the temperature is below -12°C (10°F) and the engine does not start in 15 seconds on the first try, turn the key OFF and wait 10 seconds and try again. If the engine does not start in two attempts, Press the accelerator pedal all the way to floor and hold. Turn the key to START position.
4. When the engine starts, release the key, then release the accelerator pedal gradually as the engine speeds up.
5. After idling for a few seconds, apply the brake and release the parking brake.

Using the engine block heater (if equipped)

An engine block heater warms the engine coolant, which improves starting, warms up the engine faster and allows the heater-defroster system to respond quickly. Use of an engine block heater is strongly

Starting

recommended if you live in a region where temperatures reach -23°C (-10°F) or below.

For best results, plug the heater in at least three hours before starting the vehicle. Using the heater for longer than three hours will not harm the engine, so the heater can be plugged in the night before starting the vehicle.



To prevent electrical shock, do not use your heater with ungrounded electrical systems or two-pronged (cheater) adapters.

Guarding against exhaust fumes

Although odorless and colorless, carbon monoxide is present in exhaust fumes. Take precautions to avoid its dangerous effects.



If you ever smell exhaust fumes of any kind inside your vehicle, have your dealer inspect and fix your vehicle immediately. Do not drive if you smell exhaust fumes. These fumes are harmful and could kill you.

Have the exhaust and body ventilation systems checked whenever:

- the vehicle is raised for service.
- the sound of the exhaust system changes.
- the vehicle has been damaged in a collision.



Engine exhaust, some of its constituents, and certain vehicle components contain or emit chemicals known to the State of California to cause cancer, and birth defects or other reproductive harm.

Starting

Important ventilating information

If the engine is idling while the vehicle is stopped in an open area for long periods of time, open the windows at least 2.5 cm (one inch).

Adjust the heating or air conditioning (if equipped) to bring in fresh air.

Improve vehicle ventilation by keeping all air inlet vents clear of snow, leaves and other debris.

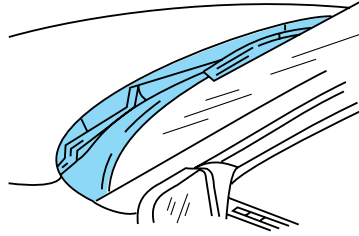

BRAKES

Your service brakes are self-adjusting. Refer to the scheduled maintenance guide for scheduled maintenance.

Occasional brake noise is normal and often does not indicate a performance concern with the vehicle's brake system. In normal operation, automotive brake systems may emit occasional or intermittent squeal or groan noises when the brakes are applied. Such noises are usually heard during the first few brake applications in the morning; however, they may be heard at any time while braking and can be aggravated by environmental conditions such as cold, heat, moisture, road dust, salt or mud. If a "metal-to-metal," "continuous grinding" or "continuous squeal" sound is present while braking, the brake linings may be worn-out and should be inspected by a qualified service technician.

Anti-lock brake system (ABS)

On vehicles equipped with an anti-lock braking system (ABS), a noise from the hydraulic pump motor and pulsation in the pedal may be observed during ABS braking events. Pedal pulsation coupled with noise while braking under panic conditions or on loose gravel, bumps, wet or snowy roads is normal and indicates proper functioning of the vehicle's anti-lock brake system. The ABS performs a self-check after you start the engine and begin to drive away. A brief mechanical noise may be heard during this test. This is normal. If a malfunction is found, the ABS warning light will come on. If the vehicle has continuous vibration or shudder in the steering wheel while braking, the vehicle should be inspected by a qualified service technician.

The ABS operates by detecting the onset of wheel lockup during brake applications and compensates for this tendency. The wheels are prevented from locking even when the brakes are firmly applied. The accompanying illustration depicts the advantage of an ABS equipped vehicle (on bottom) to a non-ABS equipped vehicle (on top) during hard braking with loss of front braking traction.

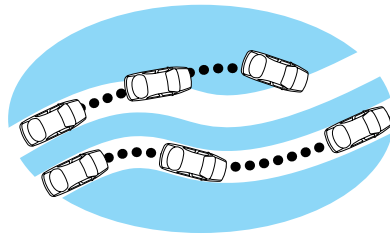

Driving

ABS warning lamp (ABS)

The (ABS) warning lamp in the instrument cluster momentarily illuminates when the ignition is turned to the ON position. If the light does not illuminate momentarily at start up, remains on or continues to flash, the ABS needs to be serviced.

With the ABS light on, the anti-lock brake system is disabled and normal braking is still effective unless the brake warning light also remains illuminated with parking brake released. (If your brake warning lamp illuminates, have your vehicle serviced immediately.)



Using ABS

- In an emergency or when maximum efficiency from the ABS is required, apply continuous force on the brake. The ABS will be activated immediately, thus allowing you to retain full steering control of your vehicle and, providing there is sufficient space, will enable you to avoid obstacles and bring the vehicle to a controlled stop.
- The Anti-Lock system does not decrease the time necessary to apply the brakes or always reduce stopping distance. Always leave enough room between your vehicle and the vehicle in front of you to stop.
- We recommend that you familiarize yourself with this braking technique. However, avoid taking any unnecessary risks.

Parking brake with auto-release (P)

Apply the parking brake whenever the vehicle is parked.

To set the parking brake:

1. Move the gearshift to P (Park).
2. Push pedal downward.

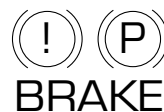
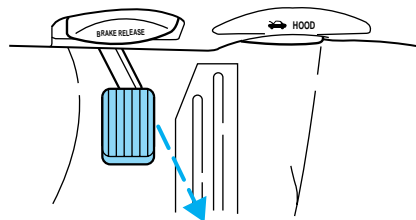

The BRAKE warning lamp in the instrument cluster illuminates and remains illuminated (when the ignition is turned ON) until the parking brake is fully released.



Always set the parking brake fully and make sure the gearshift is latched in P (Park). Turn off the ignition whenever you leave your vehicle.

The parking brake is not recommended to stop a moving vehicle. However, if the normal brakes fail, the parking brake can be used to stop your vehicle in an emergency. Since the parking brake applies only the rear brakes, the vehicle's stopping distance will increase greatly and the handling of your vehicle will be adversely affected.

Your vehicle has an automatic parking brake release. To release the parking brake:

1. Turn the ignition to the ON position.
2. Press the brake pedal.
3. Move the gearshift from the P (Park) position to one of the forward gears (the parking brake will not release automatically when you shift into reverse). The brake pedal must remain pressed while the gearshift is moved.

If the parking brake fails to release after completing this procedure, use the manual parking brake release lever.

Pull the lever to manually release the parking brake.

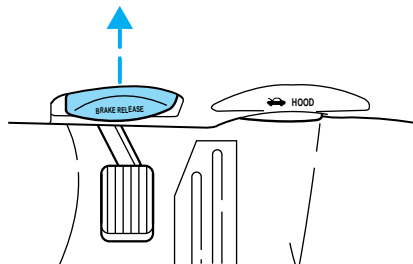

TRACTION CONTROL™

Traction Control™ helps maintain the stability and steerability of your vehicle. It is especially useful on slippery and/or hilly road surfaces. The system operates by detecting and controlling wheel spin. The system borrows many of the electronic and mechanical elements already present in the anti-lock braking system (ABS).

Wheel-speed sensors allow excess front wheel spin to be detected by the Traction Control™ portion of the ABS computer. Any excessive wheel spin is controlled by automatically applying and releasing the front brakes in conjunction with engine torque reductions. Engine torque

Driving

reduction is realized via the fully electronic spark and fuel injection systems. This process is very sensitive to driving conditions and very fast acting. The front wheels “search” for optimum traction several times a second and adjustments are made accordingly.

The Traction Control™ system will allow your vehicle to make better use of available traction on slippery surfaces. The system is a driver aid which makes your vehicle easier to handle primarily on snow and ice covered roads.

During Traction Control™ operation, TRACTION CONTROL ACTIVE is displayed on the message center. You may hear an electric motor type of sound coming from the engine compartment and the engine will not “rev-up” when you push further on the accelerator. This is normal system behavior.

If you should become stuck in snow or on a very slippery road surface, try switching the Traction Control™ system off. This may allow excess wheel spin to “dig” the vehicle out or enable a successful “rocking” maneuver. Refer to *Message center* in the *Instrumentation* chapter.

If the Traction Control™ system is cycled excessively, the brake portion of the system will shut down to prevent the front brakes from overheating. A limited Traction Control™ function using only engine torque reduction will still control wheels from over-spinning. When the front brakes have cooled down, the system will again function normally. Anti-lock braking is not affected by this condition and will function normally during the cool down period.

If a system fault is detected, CHECK TRACTION CONTROL is displayed on the message center and your vehicle should be serviced.

STEERING

Your vehicle is equipped with power steering. Power steering uses energy from the engine to help steer the vehicle.

To prevent damage to the power steering pump:

- Never hold the steering wheel to the extreme right or the extreme left for more than a few seconds when the engine is running.
- Do not operate the vehicle with a low power steering pump fluid level.

If the power steering system breaks down (or if the engine is turned off), you can steer the vehicle manually, but it takes more effort.

If the steering wanders or pulls, the condition could be caused by any of the following:

- underinflated tire(s) on any wheel(s)
- high crown in center of road
- high crosswinds
- wheels out of alignment
- loose or worn components in steering linkage

Speed sensitive steering

The steering in your vehicle is speed sensitive. At high speeds, steering assist will decrease to improve steering feel. At lower speeds, maneuverability will be increased.

See *Electronic Message Center* in the *Instrumentation* chapter for personalized adjustment.

If the amount of effort required to steer your vehicle changes at a constant vehicle speed, have the power steering system checked by your dealer or a qualified service technician.

AIR SUSPENSION SYSTEM

The air suspension system is designed to improve ride, handling and general vehicle performance during:

- certain road conditions
- steering maneuvers
- braking
- accelerations

This system keeps the rear of your vehicle at a constant level by automatically adding air or releasing air from the springs.

If you exceed the load limit, the rear air suspension may not operate and the system warning CHECK RIDE CONTROL may appear on the message center.

Driving

The air suspension shut-off switch is located on the left side of the trunk. If this switch is in the OFF position, the rear air suspension will not operate.



On vehicles equipped with Air Suspension, turn OFF the Air Suspension switch prior to jacking, hoisting or towing your vehicle.

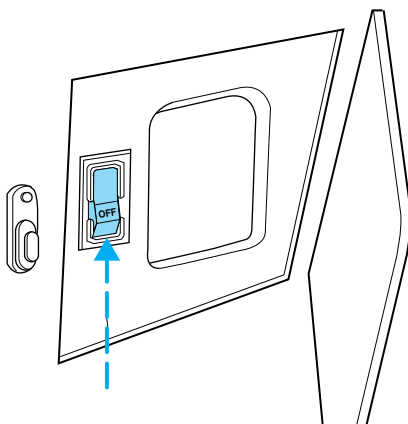

Normal vehicle operation does not require any action by the driver.

AUTOMATIC TRANSAXLE OPERATION

Brake-shift interlock

This vehicle is equipped with a brake-shift interlock feature that prevents the gearshift lever from being moved from P (Park) unless the brake pedal is pressed.

If you cannot move the gearshift lever out of P (Park) with the brake pedal depressed:

1. Apply the parking brake, turn ignition key to LOCK, then remove the key.
2. Insert the key and turn it to OFF. Apply the brake pedal and shift to N (Neutral).
3. Start the vehicle.

If it is necessary to use the above procedure to move the gearshift, it is possible that a fuse has blown or the vehicle's brakelamps are not operating properly. Refer to *Fuses and relays* in the *Roadside emergencies* chapter.



Do not drive your vehicle until you verify that the brakelamps are working.

If your vehicle gets stuck in mud or snow it may be rocked out by shifting from forward and reverse gears in a steady pattern. Press lightly

on the accelerator in each gear. Do not rock the vehicle for more than a few minutes, because it could damage the vehicle.

Do not rock the vehicle if the engine is not at normal operating temperature or damage to the transaxle may occur.

Do not rock the vehicle for more than a few minutes or damage to the transaxle and tires may occur or the engine may overheat.



Always set the parking brake fully and make sure the gearshift is latched in P (Park). Turn off the ignition whenever you leave your vehicle.



If the parking brake is fully released, but the brake warning lamp remains illuminated, the brakes may not be working properly. See your dealer or a qualified service technician.

Driving with a 4–speed automatic transaxle

Your automatic overdrive transaxle provides fully automatic operation in either D (Overdrive) or 3 (Third). Driving with the shift selector in D (Overdrive) gives the best fuel economy for normal driving conditions. For manual control start in 1 (First) and then shift manually.

To put your vehicle in gear, start the engine, depress the brake pedal, then move gearshift lever out of P (Park).



Hold the brake pedal down while you move the gearshift lever from P (Park) to another position. If you do not hold the brake pedal down, your vehicle may move unexpectedly and injure someone.

Driving

Understanding gearshift positions

P (Park)

Always come to a complete stop before shifting into P (Park). Make sure the gearshift lever is securely latched in P (Park). This locks the transaxle and prevent the front wheels from rotating.



Always set the parking brake fully and make sure the gearshift is securely latched in P (Park).



Never leave your vehicle unattended while it is running.

P R N D 3 1

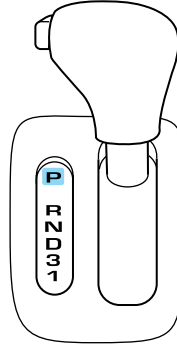

R (Reverse)

With the gearshift lever in R (Reverse), the vehicle will move backward. You should always come to a complete stop before shifting into and out of R (Reverse).

P R N D 3 1

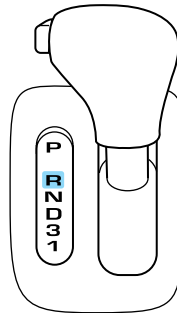

N (Neutral)

With the gearshift lever in the N (Neutral) position, the vehicle can be started and is free to roll. Hold the brake pedal down while in this position.

P R **N** D 3 1

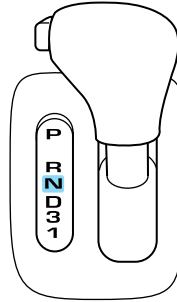

D (Overdrive)

The overdrive position is the normal driving position for an automatic overdrive transaxle. It works the same way as 3 (Third) but shifts to a fourth gear — an overdrive gear — when your vehicle cruises at a constant speed for any length of time. This fourth gear will increase your fuel economy when you travel at cruising speeds.

P R N **D** 3 1

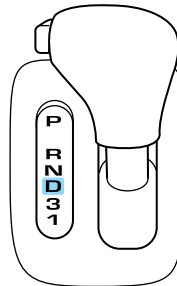

Overdrive may not be appropriate for certain terrains. If the transaxle shifts back and forth between third and fourth gears while you are driving hilly roads or if your vehicle requires additional power for climbing hills, shift into 3 (Third).

Driving

When to use 3 (Third)

3 (Third) eliminates the needless shifting back and forth between third and fourth gears that your vehicle may do when driving on hilly terrain. It also gives more engine braking than overdrive to slow your vehicle on downgrades.

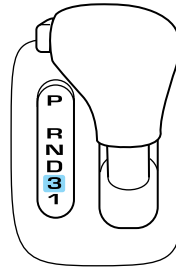

1 (First)

Use 1 (First) for when added engine braking is desired when descending steep hills.

The automatic transaxle will shift to the proper gear to ascend any grade without any need to shift to 1 (First).

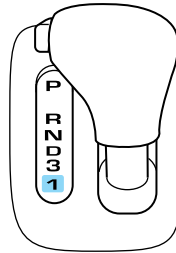

Do not go faster than 61 km/h (38 mph) when in this gear. You can upshift from 1 (First) to overdrive at any time.



When parking, do not use the gearshift in place of the parking brake. Always set the parking brake fully and make sure that the gearshift is securely latched in Park (P). Turn off the ignition whenever you leave your vehicle. Never leave your vehicle unattended while it is running. If you do not take these precautions, your vehicle may move unexpectedly and injure someone.

DRIVING THROUGH WATER

Do not drive quickly through standing water, especially if the depth is unknown. Traction or brake capability may be limited and if the ignition system gets wet, your engine may stall. Water may also enter your engine's air intake and severely damage your engine.

If driving through deep or standing water is unavoidable, proceed very slowly. Never drive through water that is higher than the bottom of the hubs (for trucks) or the bottom of the wheel rims (for cars).

Once through the water, always try the brakes. Wet brakes do not stop the vehicle as effectively as dry brakes. Drying can be improved by moving your vehicle slowly while applying light pressure on the brake pedal.

Driving through deep water where the transmission/transmission vent tube is submerged may allow water into the transmission and cause internal transmission damage.

VEHICLE LOADING

Before loading a vehicle, familiarize yourself with the following terms:

- **Base Curb Weight:** Weight of the vehicle including any standard equipment, fluids, lubricants, etc. It does not include passengers or aftermarket equipment.
- **Payload:** Combined maximum allowable weight of cargo, passengers and optional equipment. The payload equals the gross vehicle weight rating minus base curb weight.
- **GVW (Gross Vehicle Weight):** Base curb weight plus payload weight. The GVW is not a limit or a specification.
- **GVWR (Gross Vehicle Weight Rating):** Maximum total weight of the base vehicle, passengers, optional equipment and cargo. The GVWR is specific to each vehicle and is listed on the Safety Compliance Label on the driver's door pillar.

Driving

- **GAWR (Gross Axle Weight Rating):** Carrying capacity for each axle system. The GAWR is specific to each vehicle and is listed on the Safety Compliance Label on the driver's door pillar.
- **GCW (Gross Combined Weight):** The combined weight of the towing vehicle (including passengers and cargo) and the trailer.
- **GCWR (Gross Combined Weight Rating):** Maximum combined weight of towing vehicle (including passengers and cargo) and the trailer. The GCWR indicates the maximum loaded weight that the vehicle is designed to tow.
- **Maximum Trailer Weight Rating:** Maximum weight of a trailer the vehicle is permitted to tow. The maximum trailer weight rating is determined by subtracting the vehicle curb weight for each engine/transmission combination, any required option weight for trailer towing and the weight of the driver from the GCWR for the towing vehicle.
- **Maximum Trailer Weight:** Maximum weight of a trailer the loaded vehicle (including passengers and cargo) is permitted to tow. It is determined by subtracting the weight of the loaded trailer towing vehicle from the GCWR for the towing vehicle.
- **Trailer Weight Range:** Specified weight range that the trailer must fall within that ranges from zero to the maximum trailer weight rating.

Remember to figure in the tongue load of your loaded trailer when figuring the total weight.



Do not exceed the GVWR or the GAWR specified on the certification label.

Do not use replacement tires with lower load carrying capacities than the originals because they may lower the vehicle's GVWR and GAWR limitations. Replacement tires with a higher limit than the originals do not increase the GVWR and GAWR limitations.

The Certification Label, found on the inside pillar of the driver's door, lists several important vehicle weight rating limitations. Before adding any additional equipment, refer to these limitations. If you are adding weight to the front of your vehicle, (potentially including weight added to the cab), the weight added should not exceed the front axle reserve capacity (FARC). Additional frontal weight may be added to the front axle reserve capacity provided you limit your payload in other ways (i.e. restrict the number of passengers or amount of cargo carried).

You may add equipment throughout your vehicle if the total weight added is equal to or less than the total axle reserve capacity (TARC) weight. You should NEVER exceed the total axle reserve capacity.

Always ensure that the weight of passengers, cargo and equipment being carried is within the weight limitations that have been established for your vehicle including both gross vehicle weight and Front and rear gross axle weight rating limits. Under no circumstance should these limitations be exceeded. Exceeding any vehicle weight rating limitation could result in serious damage to the vehicle and/or personal injury.

TRAILER TOWING

Your vehicle is classified as a light duty towing vehicle. Refer to the following chart for towing limits:

Towing class	Light duty
Maximum gross trailer weight	454 kg (1 000 lbs.)*
Maximum tongue load	45/68 kg (100/150 lbs.)
Engine	4.6L
Hitch design	Load carrying type
Trailer-tow package option	Not required
* Vehicle speed should not exceed 72 km/h (45 mph) when towing on grades. Limit maximum gross trailer weight to 454 kg (1 000 lbs.) and maximum tongue load to 45/68 kg (100/150 lbs.): (1) when you are towing a trailer on steep hills or on moderate hills for distances longer than 8 km (5 miles) or more and; (2) on very hot days (when the temperature is above 38°C [100°F])	

Your vehicle does not come from the factory fully equipped to tow. However, you can contact your local Lincoln dealer to get the proper towing equipment. Do not tow a trailer until your vehicle has been driven at least 3 200 km (2 000 miles).

Towing a trailer places an additional load on your vehicle's engine, transmission, brakes, tires and suspension. Inspect these components carefully after towing.



Do not tow a trailer when using a temporary spare tire.

The amount of weight your loaded trailer should be no more than 907 kg (2 000 lbs.).

Driving



Do not exceed the GVWR or the GAWR specified on the certification label.



Towing trailers beyond the maximum recommended gross trailer weight could result in engine damage, transmission/axle damage, structural damage, loss of control, and personal injury.

Preparing to tow

Use the proper equipment for towing a trailer, and make sure it is properly attached to your vehicle. See your dealer or a reliable trailer dealer if you require assistance.

Hitches

Do not use hitches that clamp onto the vehicle bumper. Use a load carrying hitch. You must distribute the load in your trailer so that 10% of the total weight of the trailer is on the tongue.

Safety chains

Always connect the trailer's safety chains to the frame or hook retainers of the vehicle. To connect the trailer's safety chains, cross the chains under the trailer tongue and allow slack for turning corners.

If you use a rental trailer, follow the instructions that the rental agency gives to you.

Do not attach safety chains to the bumper.

Trailer brakes

Electric brakes and manual, automatic or surge-type trailer brakes are safe if installed properly and adjusted to the manufacturer's specifications. The trailer brakes must meet local and Federal regulations.



Do not connect a trailer's hydraulic brake system directly to your vehicle's brake system. Your vehicle may not have enough braking power and your chances of having a collision greatly increase.

The braking system of the tow vehicle is rated for operation at the GVWR not GCWR.

Trailer lamps

Do not connect a trailer's lighting system directly to your vehicle's lighting system. To get the proper equipment for hooking up your trailer's lamps, see your Lincoln Mercury dealer. Be sure to follow their instructions carefully.

If you do not install trailer lights correctly, you may cause damage to the vehicle's lighting system or other vehicle systems.

Driving while you tow

When towing a trailer:

- Ensure that you turn off your speed control. The speed control may shut off automatically when you are towing on long, steep grades.
- Consult your local motor vehicle speed regulations for towing a trailer.
- Shift out of D (Overdrive) and into 3 (Third) or a lower gear when towing up or down steep hills. This will eliminate excessive downshifting and upshifting for optimum fuel economy and transaxle cooling.
- Anticipate stops and brake gradually.

Servicing after towing

If you tow a trailer for long distances, your vehicle will require more frequent service intervals. Refer to your Scheduled Maintenance Guide for more information.

Trailer towing tips

- Practice turning, stopping and backing up in an area before starting on a trip to get the feel of the vehicle trailer combination. When turning, make wider turns so the trailer wheels will clear curbs and other obstacles.
- Allow more distance for stopping with a trailer attached.
- The trailer tongue weight should be 10% of the loaded trailer weight.
- After you have traveled 80 km (50 miles), thoroughly check your hitch, electrical connections and trailer wheel lug nuts.
- When stopped in traffic for long periods of time in hot weather, place the gearshift in P (Park) and increase idle speed. This aids engine cooling and air conditioner efficiency.

Driving

- Vehicles with trailers should not be parked on a grade. If you must park on a grade, place wheel chocks under the trailer's wheels.

Recreational towing

Follow these guidelines for your specific powertrain combination to tow your vehicle with all four wheels on the ground (such as behind a recreational vehicle).

These guidelines are designed to ensure that your transmission is not damaged due to insufficient lubrication.

All Front Wheel Drive (FWD) vehicles

An example of recreational towing is towing your vehicle behind a Motorhome. The following recreational towing guidelines are designed to ensure that your transmission is not damaged. It is not recommended to tow front wheel drive vehicles with the front drive wheels on the ground. It is recommended to tow your vehicle with the drive wheels on a dolly or two wheel car hauling trailer.

In case of a roadside emergency with a disabled vehicle (without access to wheel dollies, car hauling trailer or flatbed transport vehicle) your vehicle can be flat towed (all wheels on the ground) under the following conditions:

- Place the transmission in N (Neutral).
- Maximum speed is 56 km/h (35 mph).
- Maximum distance is 80 km (50 miles).

Roadside emergencies

GETTING ROADSIDE ASSISTANCE

To fully assist you should you have a vehicle concern, Ford offers a complimentary roadside assistance program. This program is separate from the New Vehicle Limited Warranty. The service is available:

- 24-hours, seven days a week
- for the Basic warranty period (Canada) or New Vehicle Limited Warranty period (U.S.) of three years or 60,000 km (36,000 miles), whichever comes first on Ford and Mercury vehicles, and four years or 80,000 km (50,000 miles) on Lincoln vehicles

Roadside assistance will cover:

- changing a flat tire
- jump-starts
- lock-out assistance
- fuel delivery
- towing to the nearest Ford of Canada or Ford Motor Company dealership, or towing to your selling dealership if within 56 km (35 miles). Even non-warranty related tows, like accidents or getting stuck in the mud or snow, are covered (some exclusions apply, such as impound towing or repossession).

Using roadside assistance

Complete the roadside assistance identification card and place it in your wallet for quick reference. In the United States, this card is found in the Owner Guide portfolio in the glove compartment in Ford vehicles and is mailed to you if you own a Mercury or Lincoln. In Canada, it is found in the Roadside Assistance book in the glove compartment.

To receive roadside assistance in the United States for Ford or Mercury vehicles, call 1-800-241-3673 or if you own a Lincoln vehicle, call 1-800-521-4140. In Canada call 1-800-665-2006.

Should you need to arrange roadside assistance for yourself, Ford will reimburse a reasonable amount. To obtain information about reimbursement, call 1-800-241-3673 in the United States for Ford or Mercury vehicles; or if you own a Lincoln vehicle, call 1-800-521-4140. Call 1-800-665-2006 in Canada.

Roadside emergencies

Roadside coverage beyond basic warranty

In the United States, you may purchase additional roadside assistance coverage beyond this period through the Ford Auto Club by contacting your Ford or Lincoln Mercury dealer.

HAZARD FLASHER

Use only in an emergency to warn traffic of vehicle breakdown, approaching danger, etc. The hazard flashers can be operated when the ignition is off.

- The hazard lights control is located on top of the steering column.
- Depress hazard lights control to activate all hazard flashers simultaneously.
- Depress control again to turn the flashers off.

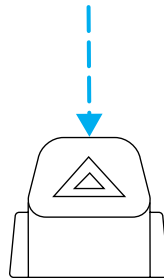

RESETTING THE FUEL PUMP SHUT-OFF SWITCH

The fuel pump shut-off switch is a device intended to stop the electric fuel pump when your vehicle has been involved in a substantial jolt.

After a collision, if the engine cranks but does not start, the fuel pump shut-off switch may have been activated.

The fuel pump shut-off switch is located behind an access door to the left of the driver's seat on the B-pillar.

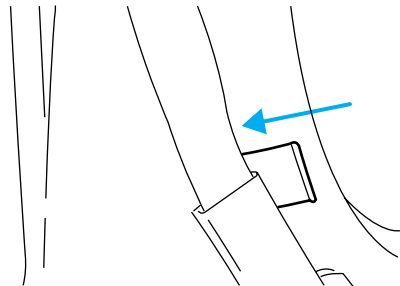

Use the following procedure to reset the fuel pump shut-off switch.

1. Turn the ignition to the OFF position.

Roadside emergencies

2. Check the fuel system for leaks.
3. If no fuel leak is apparent, reset the fuel pump shut-off switch by pushing in on the reset button.
4. Turn the ignition to the ON position. Pause for a few seconds and return the key to the OFF position.
5. Make a further check for leaks in the fuel system.

FUSES AND RELAYS

Fuses

If electrical components in the vehicle are not working, a fuse may have blown. Blown fuses are identified by a broken wire within the fuse. Check the appropriate fuses before replacing any electrical components.

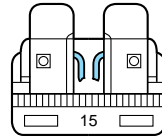

Always replace a fuse with one that has the specified amperage rating. Using a fuse with a higher amperage rating can cause severe wire damage and could start a fire.

Roadside emergencies

Standard fuse amperage rating and color

COLOR					
Fuse Rating	Mini Fuses	Standard Fuses	Maxi Fuses	Cartridge Maxi Fuses	Fuse Link Cartridge
2A	Grey	Grey	—	—	—
3A	Violet	Violet	—	—	—
4A	Pink	Pink	—	—	—
5A	Tan	Tan	—	—	—
7.5A	Brown	Brown	—	—	—
10A	Red	Red	—	—	—
15A	Blue	Blue	—	—	—
20A	Yellow	Yellow	Yellow	Blue	Blue
25A	Natural	Natural	—	—	—
30A	Green	Green	Green	Pink	Pink
40A	—	—	Orange	Green	Green
50A	—	—	Red	Red	Red
60A	—	—	Blue	—	Yellow
70A	—	—	Tan	—	Brown
80A	—	—	Natural	—	Black

Passenger compartment fuse panel

The fuse panel is located below and to the left of the steering wheel by the brake pedal. Remove the panel cover to access the fuses.

To remove a fuse use the fuse puller tool provided on the fuse panel cover.

Roadside emergencies

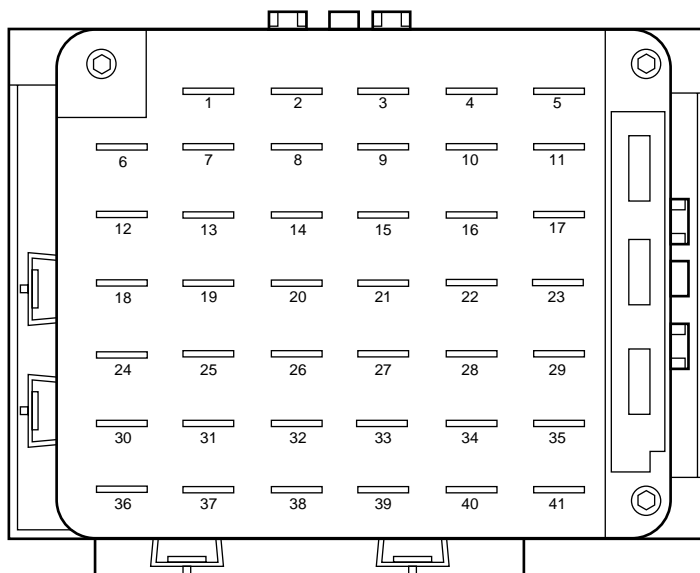

The fuses are coded as follows:

Fuse/Relay Location	Fuse Amp Rating	Passenger Compartment Fuse Panel Description
1	5A	Lighting Control Module: Anti-Theft Indicator Lamp, PWM Dimming Output, Illumination Lamps for Microphone, RR and LR Door Ashtrays, Heated Seat Switches, Rear Defrost Control Switch, EATC Control Panel, Message Center Switches, Speed Control Switches, Cigar Lighter, Console and Ashtray
2	10A	Data Link Connector (DLC), Powertrain Control Module (PCM)
3	15A	Multi-Function Switch, Cornering Lamps, High Beam and Turn Signal Input to LCM
4	10A	Power Door Locks and Power Windows Switch Backlights, Radio, Mobile Telephone Transceiver, Lighting Control Module, (RUN/ACC Sense), Electronic Day/Night Mirror

Roadside emergencies

Fuse/Relay Location	Fuse Amp Rating	Passenger Compartment Fuse Panel Description
5	10A	Virtual Image Instrument Cluster, Lighting Control Module (LCM RUN/START Sense), Autolamp Light Sensor
6	10A	Virtual Image Instrument Cluster, RF Park/Turn Lamp
7	20A	Power Point
8	20A	Fuel Filler Door Release Switch, Trunk Lid Relay
9	10A	Air Bag Diagnostic Monitor, EATC Module, Blower Motor Relay
10	30A	Windshield Wiper Motor, Windshield Wiper Module
11	10A	Ignition Coils, Radio Interference Capacitor, PCM Power Relay, Passive Anti-Theft System (PATS) Transceiver
12	10A	Lighting Control Module
13	15A	Lighting Control Module (LCM): RF Turn Lamp, Right Turn Indicator (VIC), RR Side Marker Lamps, Tail Lamps, License Lamps, LR Stop/Turn Lamps, Clock Illumination
14	20A	Cigar Lighter
15	10A	ABS Evac and Fill Connector
16	30A	Moonroof Switch
17	—	Not Used
18	10A	Lighting Control Module
19	10A	Lighting Control Module (LCM): Left Headlamp, DRL
20	15A	Multi-Function Switch: Flash to Pass, and Hazard Warning Input to LCM
21	—	Not Used
22	—	Not Used
23	10A	Digital Transmission Range Sensor
24	10A	Virtual Image Cluster-LF Turn Indicator, LF Turn Signal

Roadside emergencies

Fuse/Relay Location	Fuse Amp Rating	Passenger Compartment Fuse Panel Description
25	10A	Lighting Control Module (LCM): Right Headlamp
26	10A	Virtual Image Instrument Cluster, EATC Module
27	—	Not Used
28	10A	Shift Lock Actuator, Vehicle Dynamic Module, Virtual Image Instrument Cluster, Rear Window Defrost, Heated Seat Switch Assembly, Low Tire Pressure Module
29	10A	Radio
30	10A	Heated Mirrors
31	15A	Lighting Control Module (LCM): FCU, Electronic Day/Night Mirror, RH and LH Courtesy Lamp, Door Courtesy Lamps, RH and LH Map Lamps, RR and LR Reading Lamps, RH and LH Visor Lamps, Storage Bin Lamps, Trunk Lid Lamp, Glove Box Lamp, Light Sensor Amplifier
32	15A	Speed Control DEAC. Switch, Brake On/Off (BOO) Switch
33	—	Not Used
34	15A	Console Shift Illumination, A/C Clutch Cycling Pressure Switch, A/C Clutch Relay (DTR) Sensor, Intake Manifold Runner Control, Backup Lamps
35	—	Not Used
36	—	Not Used
37	30A	Subwoofer Amplifier, Radio
38	10A	Analog Clock, CD Player, Mobile Telephone Transceiver, RESCU
39	10A	Power Door Locks, Power Seats, Power Mirrors, Keyless Entry, LF Seat Module, LF Door Module
40	10A	Cornering Lamps
41	20A	Door Locks

Roadside emergencies

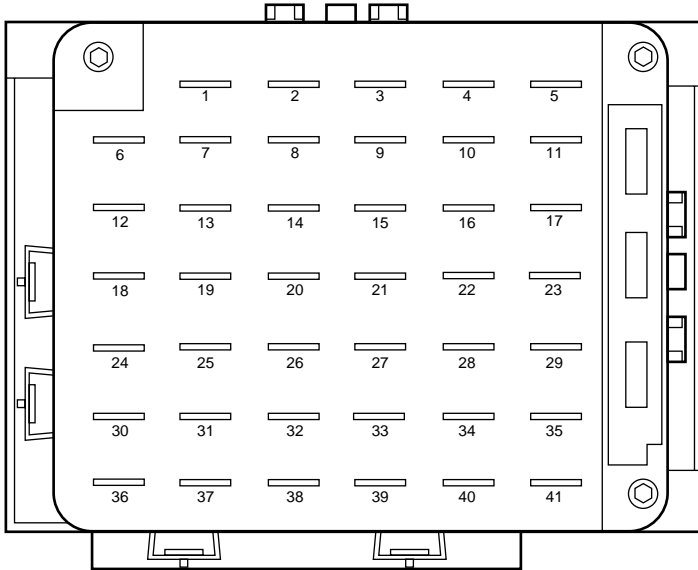

The fuses are coded as follows:

Fuse/Relay Location	Fuse Amp Rating	Passenger Compartment Fuse Panel Description
1	5A	Lighting Control Module: Anti-Theft Indicator Lamp, PWM Dimming Output, Illumination Lamps for Microphone, RR and LR Door Ashtrays, Heated Seat Switches, Rear Defrost Control Switch, EATC Control Panel, Message Center Switches, Speed Control Switches, Cigar Lighter, Console and Ashtray
2	10A	Data Link Connector (DLC), Powertrain Control Module (PCM)
3	15A	Multi-Function Switch, High Beam and Turn Signal Input to LCM
4	10A	Power Door Locks and Power Windows Switch Backlights, Radio, Lighting Control Module, (RUN/ACC Sense), Electronic Day/Night Mirror

Roadside emergencies

Fuse/Relay Location	Fuse Amp Rating	Passenger Compartment Fuse Panel Description
5	10A	Virtual Image Instrument Cluster, Lighting Control Module (LCM RUN/START Sense), Autolamp Light Sensor
6	10A	Virtual Image Instrument Cluster, RF Park/Turn Lamp
7	20A	Power Point
8	20A	Fuel Filler Door Release Switch, Trunk Lid Relay
9	10A	Air Bag Diagnostic Monitor, EATC Module, Blower Motor Relay
10	30A	Windshield Wiper Motor, Windshield Wiper Module
11	10A	Ignition Coils, Radio Interference Capacitor, PCM Power Relay, Passive Anti-Theft System (PATS) Transceiver
12	10A	Lighting Control Module
13	15A	Lighting Control Module (LCM): RF Turn Lamp, Right Turn Indicator (VIC), RR Side Marker Lamps, Tail Lamps, License Lamps, LR Stop/Turn Lamps, Clock Illumination
14	20A	Cigar Lighter
15	10A	ABS Evac and Fill Connector
16	—	Not Used
17	—	Not Used
18	10A	Lighting Control Module
19	10A	Lighting Control Module (LCM): Left Headlamp, DRL
20	15A	Multi-Function Switch: Flash to Pass, and Hazard Warning Input to LCM
21	—	Not Used
22	—	Not Used
23	10A	Digital Transmission Range Sensor
24	10A	Virtual Image Cluster-LF Turn Indicator, LF Turn Signal

Roadside emergencies

Fuse/Relay Location	Fuse Amp Rating	Passenger Compartment Fuse Panel Description
25	10A	Lighting Control Module (LCM): Right Headlamp
26	10A	Virtual Image Instrument Cluster, EATC Module
27	—	Not Used
28	10A	Shift Lock Actuator, Vehicle Dynamic Module, Virtual Image Instrument Cluster, Rear Window Defrost
29	10A	Radio
30	10A	Heated Mirrors
31	15A	Lighting Control Module (LCM): FCU, Electronic Day/Night Mirror, RH and LH Courtesy Lamp, Door Courtesy Lamps, RH and LH Map Lamps, RR and LR Reading Lamps, RH and LH Visor Lamps, Storage Bin Lamps, Trunk Lid Lamp, Glove Box Lamp, Light Sensor Amplifier
32	15A	Speed Control DEAC. Switch, Brake On/Off (BOO) Switch
33	—	Not Used
34	15A	Console Shift Illumination, A/C Clutch Cycling Pressure Switch, A/C Clutch Relay (DTR) Sensor, Intake Manifold Runner Control, Backup Lamps
35	—	Not Used
36	—	Not Used
37	30A	Subwoofer Amplifier, Radio
38	10A	Analog Clock, CD Player
39	10A	Power Door Locks, Power Seats, Power Mirrors, Keyless Entry, LF Seat Module, LF Door Module
40	—	Not Used
41	20A	Door Locks

Roadside emergencies

Power distribution box

The power distribution box is located in the engine compartment. The power distribution box contains high-current fuses that protect your vehicle's main electrical systems from overloads.



Always disconnect the battery before servicing high current fuses.



Always replace the cover to the Power Distribution Box before reconnecting the battery or refilling fluid reservoirs.

If the battery has been disconnected and reconnected, refer to the *Battery* section of the *Maintenance and care* chapter.

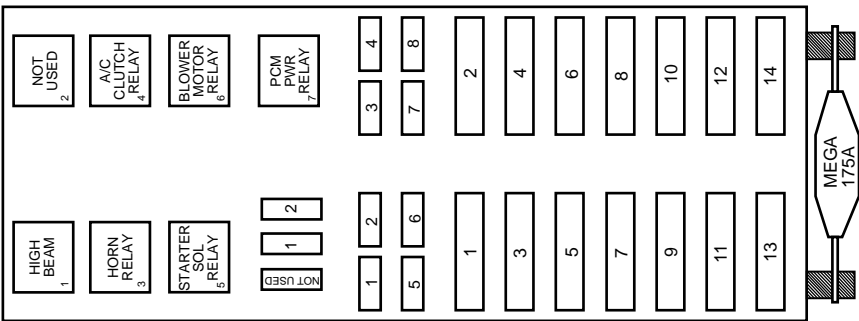

The high-current fuses are coded as follows:

Fuse/Relay Location	Fuse Amp Rating	Power Distribution Box Description
—	175	Generator/Voltage Regulator
1	30A**	Driver's Seat Module
2	30A**	Passenger's Seat Module
3	40A**	Ignition Switch
4	40A**	Ignition Switch
5	40A**	Driver Window
6	30A**	Low Speed Cooling Fan
7	30A**	Powertrain Control Module

Roadside emergencies

Fuse/Relay Location	Fuse Amp Rating	Power Distribution Box Description
8	40A**	Rear Window Defrost Control
9	60A**	I/P Fuse Panel
10	60A**	Lighting Control Module
11	60A**	Compressor Relay
12	60A**	Anti-Lock Brake Control Module
13	40A**	Blower Motor
14	60A**	High Speed Cooling Fan
1	30A*	PCM
2	20A*	ALT SENSE
3	30A*	Right Rear Passenger Window
4	30A*	Air Suspension
5	—	Not Used
6	20A*	Horns
7	15A*	High Beam
8	30A*	Right Front Passenger Window
1	—	A/C Diode
2	—	PCM Diode
* Mini Fuses ** Maxi Fuses		

Auxiliary relay box

The auxiliary relay box is located in the engine compartment. The auxiliary relay box contains the high and low speed cooling fan relays.

CHANGING THE TIRES

If you get a flat tire while driving, do not apply the brake heavily. Instead, gradually decrease your speed. Hold the steering wheel firmly and slowly move to a safe place on the side of the road.

Roadside emergencies

Tire change procedure

 To prevent the vehicle from moving when you change a tire, be sure the parking brake is set, then block (in both directions) the wheel that is diagonally opposite (other side and end of the vehicle) to the tire being changed.

 If the vehicle slips off the jack, you or someone else could be seriously injured.

1. Park on a level surface, activate hazard flashers and set parking brake.
2. Place gearshift lever in P (Park) and turn engine OFF.
3. Remove the spare tire, jack and lug wrench.
4. Locate pry off notch (if equipped) and remove the center ornament from the aluminum wheel with the tapered end of the wheel nut wrench that came with your vehicle. Insert and twist the handle, then pry against the wheel.

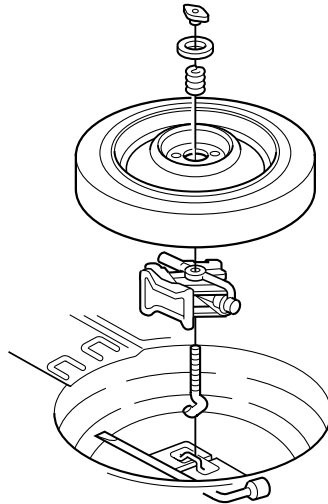

Roadside emergencies

5. Loosen each wheel lug nut one-half turn counterclockwise but do not remove them until the wheel is raised off the ground. Refer to *Anti-theft lug nuts* for information on removing anti-theft lug nuts.

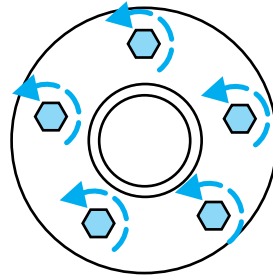

 On vehicles equipped with Air Suspension, turn OFF the Air Suspension switch prior to jacking, hoisting or towing your vehicle.

Refer to *Air suspension system* in the *Driving* chapter for more information.

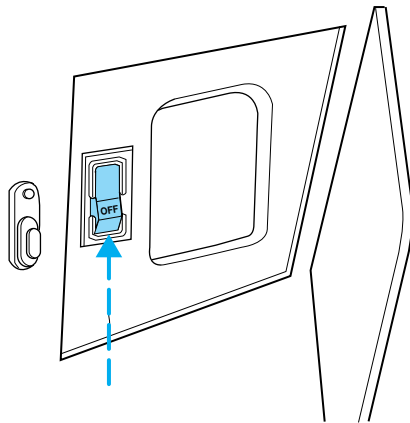

6. Put the jack in the jack notch next to the door closest to the tire you are changing. Turn the jack handle clockwise until the wheel is completely off the ground.

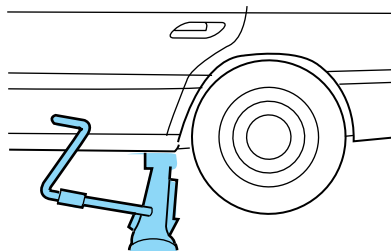

Roadside emergencies



To lessen the risk of personal injury, do not put any part of your body under the vehicle while changing a tire. Do not start the engine when your vehicle is on the jack. The jack is only meant for changing the tire.

7. Remove the lug nuts with the lug wrench. Replace the flat tire with the spare tire, making sure the valve stem is facing outward. Reinstall lug nuts until the wheel is snug against the hub. Do not fully tighten the lug nuts until the wheel has been lowered.
8. Lower the wheel by turning the jack handle counterclockwise.
9. Remove the jack and fully tighten the lug nuts in the order shown.
10. Put flat tire, jack and lug wrench away.
11. Turn on the air suspension switch.

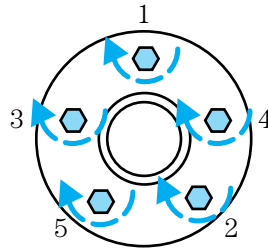

Anti-theft lug nuts (if equipped)

If your vehicle is equipped with this feature, one of the lug nuts on each wheel must be removed and replaced with a special key. The key and registration card are attached to the lug wrench and stored with the spare tire. If you lose the key, send the registration card to the manufacturer (not the dealer) to get a replacement key. If the lug wrench/lug nut key assembly is lost, see your nearest Ford or Lincoln/Mercury dealer who has access to the master set of keys. **Do not use an impact wrench with the anti-theft key.**

To remove the anti-theft lug nut:

1. Insert the key over the locking lug nut. Make sure you hold the key square to the lug nut. If you hold the key at an angle, you could damage the key and the lug nut.
2. Place the lug nut wrench over the lug nut key and apply pressure on the key with the wrench.



Roadside emergencies

3. Turn the wrench in a counterclockwise direction to remove the lug nut.

To install the anti-theft lug nut:

1. Insert the key over the locking lug nut.
2. Place the lug nut wrench over the lug nut key and apply pressure on the key with the wrench.
3. Install the lug nut.

JUMP STARTING YOUR VEHICLE



The gases around the battery can explode if exposed to flames, sparks, or lit cigarettes. An explosion could result in injury or vehicle damage.



Do not push start your vehicle. You could damage the catalytic converter.



Batteries contain sulfuric acid which can burn skin, eyes, and clothing, if contacted.

Do not attempt to push start your vehicle. Automatic transmissions do not have push-start capability.

Preparing your vehicle

1. **Use only a 12-volt supply to start your vehicle.**
2. Do not disconnect the battery of the disabled vehicle as this could damage the vehicle's electrical system.
3. Park the booster vehicle close to the hood of the disabled vehicle making sure the two vehicles **do not** touch. Set the parking brake on both vehicles and stay clear of the engine cooling fan and other moving parts.
4. Check all battery terminals and remove any excessive corrosion before you attach the battery cables. Ensure that vent caps are tight and level.
5. Turn the heater fan on in both vehicles to protect any electrical surges. Turn all other accessories off.

Roadside emergencies

Connecting the jumper cables

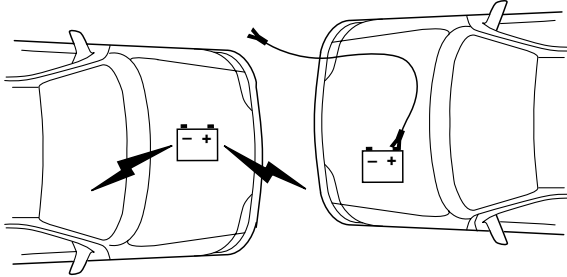

1. Connect the positive (+) booster cable to the positive (+) terminal of the discharged battery.

Note: In the illustrations, *lightning bolts* are used to designate the assisting (boosting) battery.

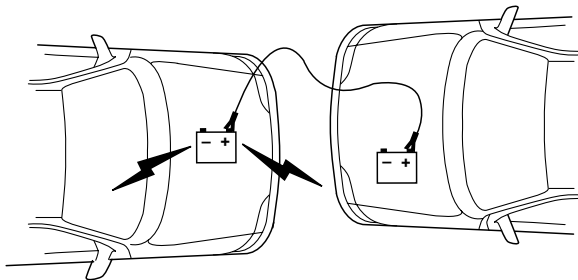

2. Connect the other end of the positive (+) cable to the positive (+) terminal of the assisting battery.

Roadside emergencies

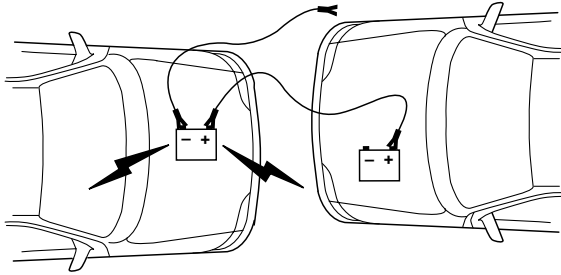

3. Connect the negative (-) cable to the negative (-) terminal of the assisting battery.

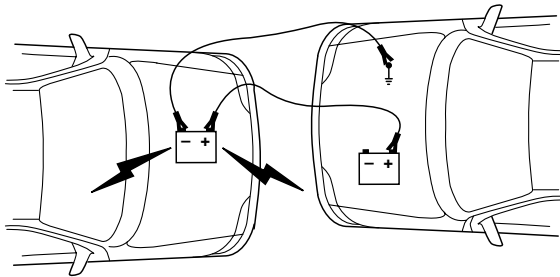

4. Make the final connection of the negative (-) cable to an exposed metal part of the stalled vehicle's engine, away from the battery and the carburetor/fuel injection system. **Do not** use fuel lines, engine rocker covers or the intake manifold as *grounding* points.



Do not connect the end of the second cable to the negative (-) terminal of the battery to be jumped. A spark may cause an explosion of the gases that surround the battery.

5. Ensure that the cables are clear of fan blades, belts, moving parts of both engines, or any fuel delivery system parts.

Roadside emergencies

Jump starting

1. Start the engine of the booster vehicle and run the engine at moderately increased speed.
2. Start the engine of the disabled vehicle.
3. Once the disabled vehicle has been started, run both engines for an additional three minutes before disconnecting the jumper cables.

Removing the jumper cables

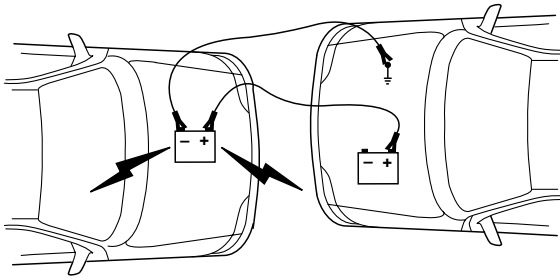

Remove the jumper cables in the reverse order that they were connected.

1. Remove the jumper cable from the *ground* metal surface.

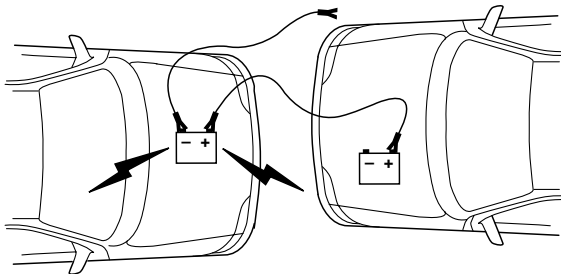

2. Remove the jumper cable on the negative (-) connection of the booster vehicle's battery.

Roadside emergencies

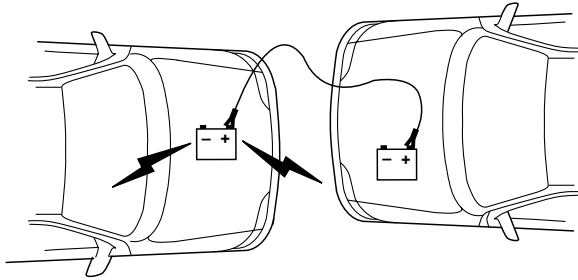

3. Remove the jumper cable from the positive (+) terminal of the booster vehicle's battery.

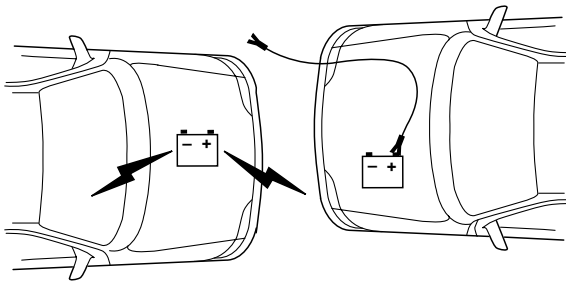

4. Remove the jumper cable from the positive (+) terminal of the disabled vehicle's battery.

After the disabled vehicle has been started and the jumper cables removed, allow it to idle for several minutes so the engine computer can *relearn* its idle conditions.

Roadside emergencies

WRECKER TOWING

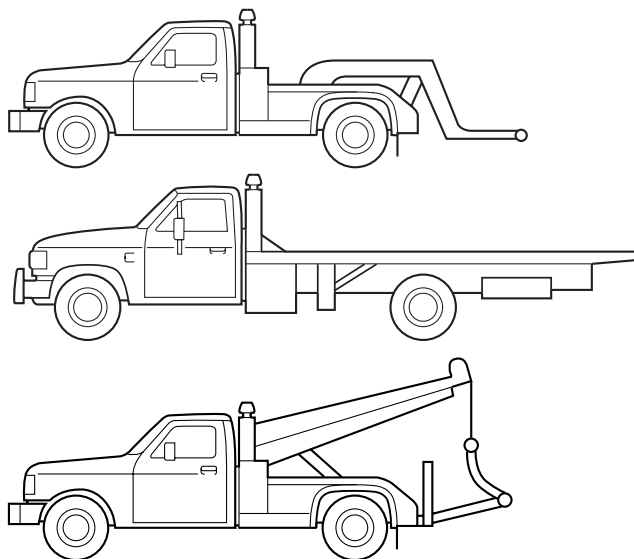

If you need to have your vehicle towed, contact a professional towing service or, if you are a member, your roadside assistance center.

It is recommended that your vehicle be towed by wheel lift or flatbed equipment. Do not tow your vehicle from the front using slingbelt equipment. However, if your vehicle has experienced a failure in the air suspension system and is in the full down position, then your vehicle must be towed from the rear using a slingbelt with T-hooks.

If your vehicle is to be towed from the rear using wheel lift or slingbelt equipment, the front wheels (drive wheels) must be placed on a dolly to prevent damage to the transaxle.

Before your vehicle can be towed, the air suspension control in the luggage compartment must be turned to the OFF position (if equipped).

If the vehicle is towed by other means or incorrectly, vehicle damage may occur.

Ford Motor Company provides a towing manual for all authorized tow truck operators. Have your tow truck operator refer to this manual for proper hook-up and towing procedures for your vehicle.

Maintenance and care

SERVICE RECOMMENDATIONS

To help you service your vehicle:

- We highlight do-it-yourself items in the engine compartment for easy location.
- We provide a Scheduled Maintenance Guide which makes tracking routine service easy.

If your vehicle requires professional service, your dealership can provide necessary parts and service. Check your “Warranty Guide” to find out which parts and services are covered.

Use only recommended fuels, lubricants, fluids and service parts conforming to specifications. Motorcraft parts are designed and built to provide the best performance in your vehicle.

PRECAUTIONS WHEN SERVICING YOUR VEHICLE

Be especially careful when inspecting or servicing your vehicle.

- Do not work on a hot engine.
- When the engine is running, keep loose clothing, jewelry or long hair away from moving parts.
- Do not work on a vehicle with the engine running in an enclosed space, unless you are sure you have enough ventilation.
- Keep all lit cigarettes, open flames and other lit material away from the battery and all fuel related parts.

If you disconnect the battery, the engine must “relearn” its idle conditions before your vehicle will drive properly, as explained in the *Battery* section in this chapter.

Working with the engine off

1. Set the parking brake, and ensure the gearshift is securely latched in park.
2. Turn off the engine and remove the key.
3. Block the wheels to prevent the vehicle from moving unexpectedly.

Working with the engine on

1. Set the parking brake and ensure the gearshift is securely latched in P (Park).
2. Block the wheels to prevent the vehicle from moving unexpectedly.

Maintenance and care



Do not start your engine with the air cleaner removed and do not remove it while the engine is running.

OPENING THE HOOD

1. Inside the vehicle, pull the hood release handle located under the bottom of the instrument panel.
2. Go to the front of the vehicle and release the auxiliary latch that is located under the front center of the hood.
3. Lift the hood until the lift cylinders hold it open.

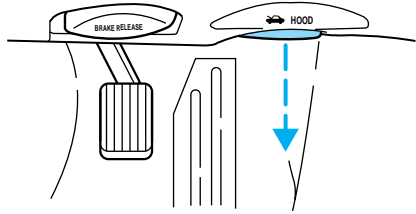

Maintenance and care

IDENTIFYING COMPONENTS IN THE ENGINE COMPARTMENT

4.6L DOHC V8 engine

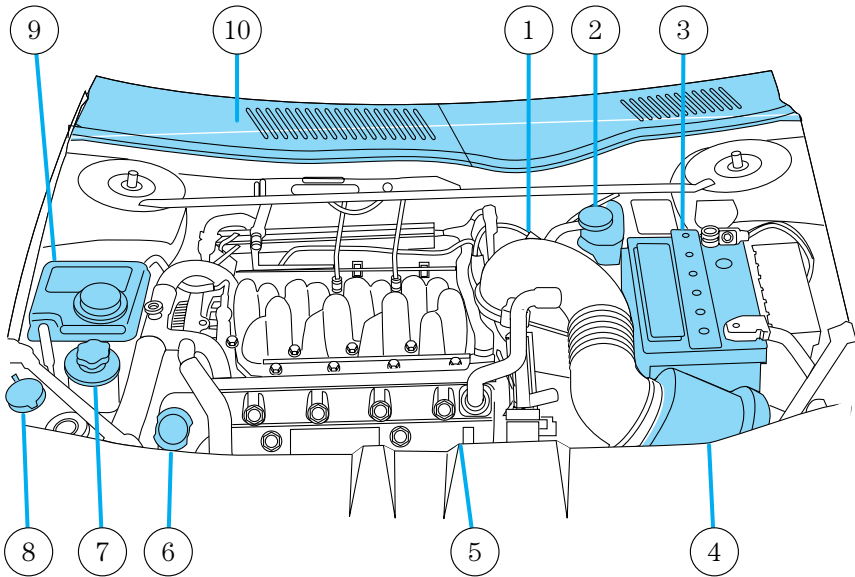

1. Automatic transmission fluid dipstick
2. Brake fluid reservoir
3. Battery
4. Air filter assembly
5. Engine oil dipstick
6. Engine oil filler cap
7. Power steering fluid reservoir
8. Windshield washer fluid reservoir
9. Engine coolant reservoir
10. Cabin air filter

Maintenance and care

ENGINE OIL

Checking the engine oil

Refer to the Scheduled Maintenance Guide for the appropriate intervals for checking the engine oil.

1. Make sure the vehicle is on level ground.
2. Turn the engine off and wait a few minutes for the oil to drain into the oil pan.
3. Set the parking brake and ensure the gearshift is securely latched in P (Park).
4. Open the hood. Protect yourself from engine heat.
5. Locate and carefully remove the engine oil level indicator (dipstick).

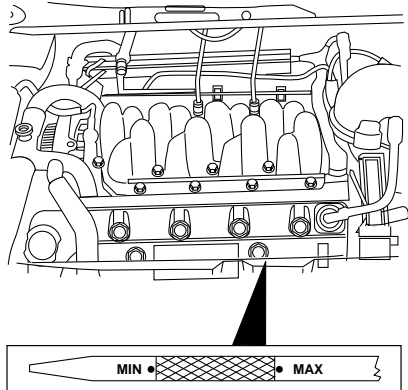

6. Wipe the indicator clean. Insert the indicator fully, then remove it again.

- If the oil level is **between the MIN and MAX marks**, the oil level is acceptable. **DO NOT ADD OIL.**

Maintenance and care

- If the oil level is below the MIN mark, add enough oil to raise the level within the MIN-MAX range.

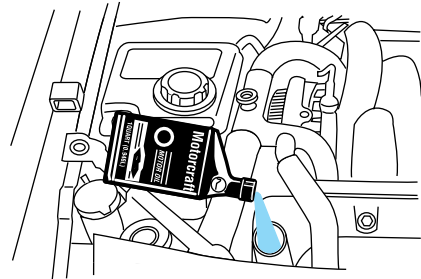

- Oil levels above the MAX mark may cause engine damage. Some oil must be removed from the engine by a service technician.
7. Put the indicator back in and ensure it is fully seated.

Adding engine oil

1. Check the engine oil. For instructions, refer to *Checking the engine oil* in this chapter.
2. If the engine oil level is not within the normal range, add only certified engine oil of the recommended viscosity. Remove the engine oil filler cap and use a funnel to pour the engine oil into the opening.
3. Recheck the engine oil level. Make sure the oil level is not above the MAX mark on the engine oil level indicator (dipstick).
4. Install the indicator and ensure it is fully seated.
5. Fully install the engine oil filler cap by turning the filler cap clockwise until three clicks can be heard.

To avoid possible oil loss, DO NOT operate the vehicle with the engine oil level indicator and/or the engine oil filler cap removed.

Maintenance and care

Engine oil and filter recommendations

Look for this certification trademark.

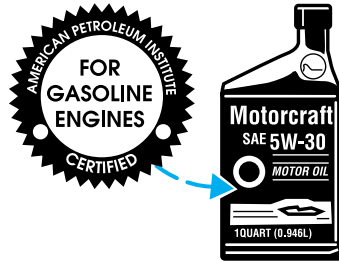

Use SAE 5W-30 motor oil certified for gasoline engines by the American Petroleum Institute (API).

Motor oil displaying the API certification trademark will meet all requirements for your vehicle's engine.

Ford oil specification is WSS-M2C153-G.

Do not use supplemental engine oil additives, oil treatments or engine treatments. They are unnecessary and could, under certain conditions, lead to engine damage which is not covered by your warranty.

Change your engine oil and filter according to the appropriate schedule listed in the Scheduled Maintenance Guide.

Ford production and aftermarket (Motorcraft) oil filters are designed for added engine protection and long life. If a replacement oil filter is used that does not meet Ford material and design specifications, start-up engine noises or knock may be experienced.

It is recommended you use the appropriate Motorcraft oil filter (or another brand meeting Ford specifications) for your engine application.

Maintenance and care

BRAKE FLUID (⚠)

Checking and adding brake fluid

Brake fluid should be checked and refilled as needed. Refer to the Scheduled Maintenance Guide for the service interval schedules.

1. Clean the reservoir cap before removal to prevent dirt or water from entering the reservoir.

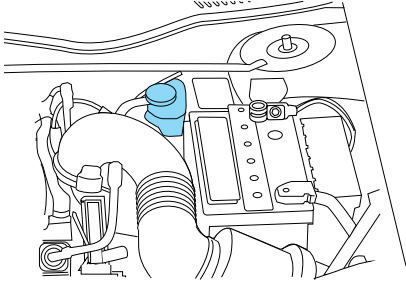

2. Visually inspect the fluid level.

3. If necessary, add brake fluid from a clean un-opened container until the level reaches MAX. Do not fill above this line.

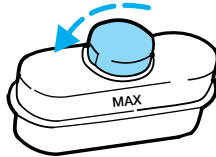

4. Use only brake fluids certified to meet Ford specifications. Refer to *Lubricant specifications* in the *Capacities and specifications* chapter. DOT 3 fluid is recommended. However, if DOT 3 is not available, DOT 4 fluid can be used.



Brake fluid is toxic. If brake fluid contacts the eyes, flush eyes with running water for 15 minutes. Seek medical attention if irritation persists. If taken internally, drink water and induce vomiting. Seek medical attention immediately.



If you use DOT 5 or any other brake fluid that is not DOT 3 or DOT 4, you will cause permanent damage to your brakes.



Do not let the reservoir for the master cylinder run dry, this may cause the brakes to fail.

Maintenance and care

WINDSHIELD WASHER FLUID

Checking and adding washer fluid

Check the washer fluid whenever you stop for fuel. The reservoir is highlighted with a  symbol.

If the level is low, add enough fluid to fill the reservoir. In very cold weather, do not fill the reservoir all the way.

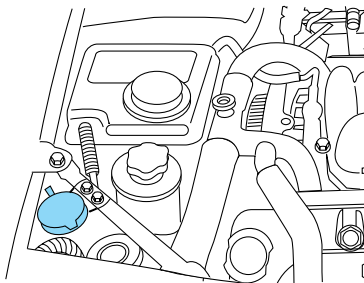

Only use a washer fluid that meets Ford specifications. Refer to *Lubricant specifications* in the *Capacities and specifications* chapter.

State or local regulations on volatile organic compounds may restrict the use of methanol, a common windshield washer antifreeze additive.

Washer fluids containing non-methanol antifreeze agents should be used only if they provide cold weather protection without damaging the vehicle's paint finish, wiper blades or washer system.



Do not put washer fluid in the engine coolant reservoir. Washer fluid placed in the cooling system may harm engine and cooling system components.

ENGINE COOLANT

Checking engine coolant

Your engine's cooling system has been factory-filled with a 50/50 mixture of distilled water and Ford Premium Engine Coolant E2FZ-19549-AA (in Canada, Motorcraft CXC-8-B), or an equivalent premium engine coolant that meets Ford specification ESE-M97B44-A.

A **50/50 mixture** of distilled water and Ford Premium Engine Coolant **provides:**

- **maximum cooling system efficiency.**
- **freeze protection down to -36° C (-34° F).**
- **boiling protection up to 129° C (265° F).**
- **protection against rust and other forms of corrosion.**

Maintenance and care

The engine coolant must be maintained at the correct fluid level and concentration to work properly. If the engine coolant fluid level and concentration is not maintained correctly, damage to the engine and cooling system may result.

When the engine is cold, check the level of the engine coolant in the reservoir.

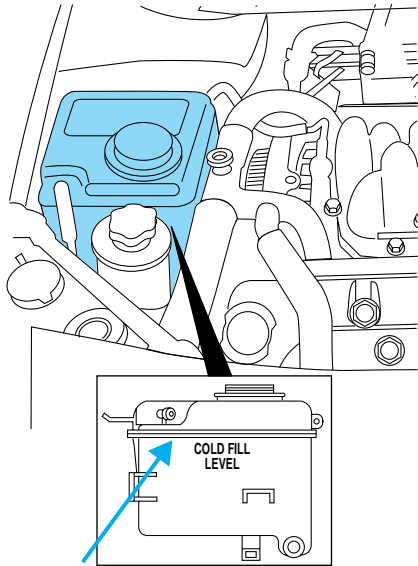

- The engine coolant should be at the “cold fill level” as listed on the engine coolant reservoir.
- If the engine coolant reservoir becomes empty, the LOW ENGINE COOLANT warning will illuminate in the message center.
- Refer to the Scheduled Maintenance Guide for service interval schedules.
- Be sure to read and understand *Precautions when servicing your vehicle* in this chapter.

If the engine coolant has not been checked at the recommended interval, the engine coolant reservoir may become low or empty. If this occurs, the LOW ENGINE COOLANT warning will illuminate and you will need to add engine coolant to the reservoir. Refer to *Adding engine coolant* in this chapter.

Maintenance and care



Automotive fluids are not interchangeable; do not use engine coolant, antifreeze or windshield washer fluid outside of its specified function and vehicle location.

Adding engine coolant

Use only **Ford Premium Engine Coolant E2FZ-19549-AA** (in Canada, Motorcraft CXC-10) or a premium engine coolant that meets Ford specification ESE-M97B44-A.

- **DO NOT USE Ford Extended Life Engine Coolant F6AZ-19544-AA (orange in color).**
- **DO NOT USE a DEX-COOL® engine coolant or an equivalent engine coolant that meets Ford specification WSS-M97B44-D.**
- **DO NOT USE alcohol or methanol antifreeze or any engine coolants mixed with alcohol or methanol antifreeze.**
- **DO NOT USE supplemental coolant additives in your vehicle. These additives may harm your engine's cooling system.**
- **DO NOT MIX recycled coolant and conventional coolant together in your vehicle. Mixing of engine coolants may harm your engine's cooling system.**
- **The use of an improper coolant may harm engine and cooling system components and may void the warranty of your vehicle's engine cooling system. If you are unsure which type of coolant your vehicle requires, contact your local dealer.**



Do not put engine coolant in the windshield washer fluid reservoir. If engine coolant is sprayed onto the windshield, it could make it difficult to see through the windshield.

When the engine is cool, add a **50/50 mixture** of engine coolant and distilled water to the engine coolant reservoir, until the coolant is at the “cold fill level” or within the “ cold fill range” as listed in the engine coolant reservoir (depending upon application).

- **NEVER increase the coolant concentration above 60%.**
- **NEVER decrease the coolant concentration below 40%.**
- **Engine coolant concentrations above 60% or below 40% will decrease the freeze protection characteristics of the engine coolant and may cause engine damage.**

Maintenance and care

Plain water may be added in an emergency, but you **must** replace it with a 50/50 mixture of engine coolant and distilled water as soon as possible.

Check the coolant level in the reservoir before you drive your vehicle the next few times (with the engine cool). If necessary, add a **50/50 mixture** of engine coolant and distilled water to the engine coolant reservoir until the coolant level is at the “cold fill level” or within the “cold fill range” as listed on the reservoir (depending upon application).

Have your dealer check the engine cooling system for leaks if you have to add more than 1.0 liter (1.0 quart) of engine coolant per month.



To avoid scalding hot steam or coolant from being released from the engine cooling system, never remove the radiator cap while the engine is running or hot. Failure to follow this warning may result in damage to the engine’s cooling system and possible severe personal injury.

If you must remove the radiator cap, follow these steps to avoid personal injury:

1. Before you remove the cap, turn the engine off and let it cool.
2. When the engine is cool, wrap a thick cloth around the cap. Slowly turn cap counterclockwise until pressure begins to release.
3. Step back while the pressure releases.
4. When you are sure that all the pressure has been released, use the cloth to turn it counterclockwise and remove the cap.

Recycled engine coolant

Ford Motor Company recommends the use of a recycled engine coolant produced by Ford-approved processes.

Not all coolant recycling processes produce coolant which meets Ford specification ESE-M97B44-A. Use of a recycled engine coolant which does not meet the Ford specification may harm engine and cooling system components.



Always dispose of used automotive fluids in a responsible manner. Follow your community’s regulations and standards for recycling and disposing of automotive fluids.

Coolant refill capacity

To find out how much fluid your vehicle's cooling system can hold, refer to *Refill capacities* in the *Capacities and specifications* chapter.

Fill your engine coolant reservoir as outlined in *Adding engine coolant* in this chapter.

Severe climates

If you drive in extremely cold climates (less than -36°C [-34°F]):

- **it may be necessary to increase the coolant concentration above 50%.**
- **NEVER increase the coolant concentration above 60%.**
- **increased engine coolant concentrations above 60% will decrease the overheat protection characteristics of the engine coolant and may cause engine damage.**
- **refer to the chart on the coolant container to ensure the coolant concentration in your vehicle will provide adequate freeze protection at the temperatures in which you drive in the winter months.**

If you drive in extremely hot climates:

- **it is still necessary to maintain the coolant concentration above 40%.**
- **NEVER decrease the coolant concentration below 40%.**
- **decreased engine coolant concentrations below 40% will decrease the corrosion protection characteristics of the engine coolant and may cause engine damage.**
- **decreased engine coolant concentrations below 40% will decrease the freeze protection characteristics of the engine coolant and may cause engine damage.**
- **refer to the chart on the coolant container to ensure the coolant concentration in your vehicle will provide adequate protection at the temperatures in which you drive.**

Vehicles driven year-round in non-extreme climates should use a 50/50 mixture of engine coolant and distilled water for optimum cooling system and engine protection.

Maintenance and care

CHECKING AND ADDING POWER STEERING FLUID

Check the power steering fluid. Refer to the Scheduled Maintenance Guide for the service interval schedules. If adding fluid is necessary, use only MERCON® ATF.

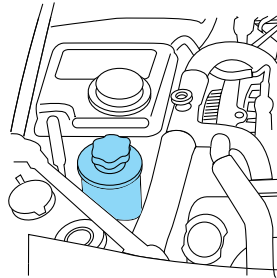

1. Start the engine and let it run until it reaches normal operating temperature (the engine coolant temperature gauge indicator will be near the center of the normal area between H and C).
2. While the engine idles, turn the steering wheel left and right several times.
3. Turn the engine off.
4. Check the fluid level in the reservoir. It should be between the MIN and MAX lines. Do not add fluid if the level is in this range.

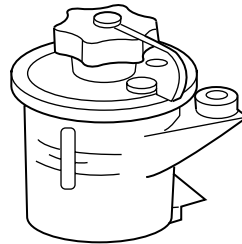

5. If the fluid is low, add fluid in small amounts, continuously checking the level until it reaches the range between the MIN and MAX lines. Be sure to put the cap back on the reservoir.

TRANSMISSION FLUID

Checking automatic transmission fluid

Refer to your Scheduled Maintenance Guide for scheduled intervals for fluid checks and changes. Your transaxle does not consume fluid. However, the fluid level should be checked if the transaxle is not working properly, i.e., if the transaxle slips or shifts slowly or if you notice some sign of fluid leakage.

Maintenance and care

Automatic transmission fluid expands when warmed. To obtain an accurate fluid check, drive the vehicle until it is warmed up (approximately 30 km [20 miles]). If your vehicle has been operated for an extended period at high speeds, in city traffic during hot weather or pulling a trailer, the vehicle should be turned off for about 30 minutes to allow fluid to cool before checking.

1. Drive the vehicle 30 km (20 miles) or until it reaches normal operating temperature.
2. Park the vehicle on a level surface and engage the parking brake.
3. With the parking brake engaged and your foot on the brake pedal, start the engine and move the gearshift lever through all of the gear ranges. Allow sufficient time for each gear to engage.
4. Latch the gearshift lever in P (Park) and leave the engine running.
5. Remove the dipstick, wiping it clean with a clean, dry lint free rag. If necessary, refer to *Identifying components in the engine compartment* in this chapter for the location of the dipstick.
6. Install the dipstick making sure it is fully seated in the filler tube.
7. Remove the dipstick and inspect the fluid level. The fluid should be in the designated areas for normal operating temperature.

Low fluid level

Do not drive the vehicle if the fluid level is at the bottom of the dipstick and the outside temperatures are above 10°C (50°F).



Correct fluid level

The transmission fluid should be checked at normal operating temperatures 66°C-77°C (150°F-170°F) on a level surface. The normal operating temperature can be reached after approximately 30 km (20 miles) of driving.

The transmission fluid should be in this range if at normal operating temperature (66°C-77°C [150°F-170°F]).



Maintenance and care

High fluid level

Fluid levels above the safe range may result in transaxle failure. An overfill condition of transmission fluid may cause shift and/or engagement concerns and/or possible damage.



High fluid levels can be caused by an overheating condition.

Adjusting automatic transmission fluid levels

Before adding any fluid, make sure the correct type is used. The type of fluid used is normally indicated on the dipstick and also in the *Lubricant specifications* section in the *Capacities and specifications* chapter.

Use of a non-approved automatic transmission fluid may cause internal transaxle component damage.

If necessary, add fluid in 250 mL (1/2 pint) increments through the filler tube until the level is correct.

If an overfill occurs, excess fluid should be removed by a qualified technician.



An overfill condition of transmission fluid may cause shift and/or engagement concerns and/or possible damage.

Maintenance and care

BATTERY

Your vehicle is equipped with a Motorcraft maintenance-free battery which normally does not require additional water during its life of service.

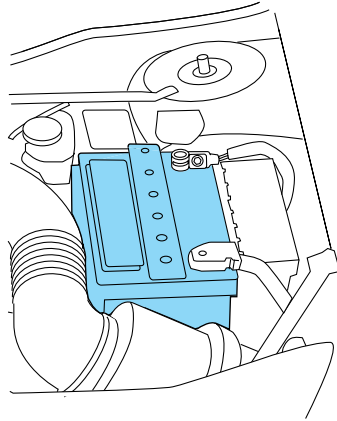

However, for severe usage or in high temperature climates, check the battery electrolyte level. Refer to the Scheduled Maintenance Guide for the service interval schedules.

Keep the electrolyte level in each cell up to the “level indicator”. Do not overfill the battery cells.

If the electrolyte level in the battery is low, you can add plain tap water to the battery, as long as you do not use hard water (water with a high mineral or alkali content). If possible, however, try to only fill the battery cells with distilled water. If the battery needs water often, have the charging system checked.

If your battery has a cover/shield, make sure it is reinstalled after the battery has been cleaned or replaced.

For longer, trouble-free operation, keep the top of the battery clean and dry. Also, make certain the battery cables are always tightly fastened to the battery terminals.

If you see any corrosion on the battery or terminals, remove the cables from the terminals and clean with a wire brush. You can neutralize the acid with a solution of baking soda and water.

Maintenance and care



Batteries normally produce explosive gases which can cause personal injury. Therefore, do not allow flames, sparks or lighted substances to come near the battery. When working near the battery, always shield your face and protect your eyes. Always provide proper ventilation.



When lifting a plastic-cased battery, excessive pressure on the end walls could cause acid to flow through the vent caps, resulting in personal injury and/or damage to the vehicle or battery. Lift the battery with a battery carrier or with your hands on opposite corners.



Keep batteries out of reach of children. Batteries contain sulfuric acid. Avoid contact with skin, eyes or clothing. Shield your eyes when working near the battery to protect against possible splashing of acid solution. In case of acid contact with skin or eyes, flush immediately with water for a minimum of 15 minutes and get prompt medical attention. If acid is swallowed, call a physician immediately.

Because your vehicle's engine is electronically controlled by a computer, some control conditions are maintained by power from the battery. When the battery is disconnected or a new battery is installed, the engine must relearn its idle and fuel trim strategy for optimum driveability and performance. To begin this process:

1. With the vehicle at a complete stop, set the parking brake.
 2. Put the gearshift in P (Park), turn off all accessories and start the engine.
 3. Run the engine until it reaches normal operating temperature.
 4. Allow the engine to idle for at least one minute.
 5. Turn the A/C on and allow the engine to idle for at least one minute.
 6. With your foot on the brake pedal and with the A/C on, put the vehicle in D (Drive) and allow the engine to idle for at least one minute.
 7. Drive the vehicle to complete the relearning process.
- The vehicle may need to be driven 16 km (10 miles) or more to relearn the idle and fuel trim strategy.

Maintenance and care

- **If you do not allow the engine to relearn its idle trim, the idle quality of your vehicle may be adversely affected until the idle trim is eventually relearned.**

If the battery has been disconnected or a new battery has been installed, the clock must be reset once the battery is reconnected.

- Always dispose of automotive batteries in a responsible manner. Follow your local authorized standards for disposal. Call your local authorized recycling center to find out more about recycling automotive batteries.

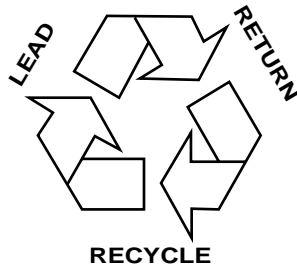

CABIN AIR FILTER

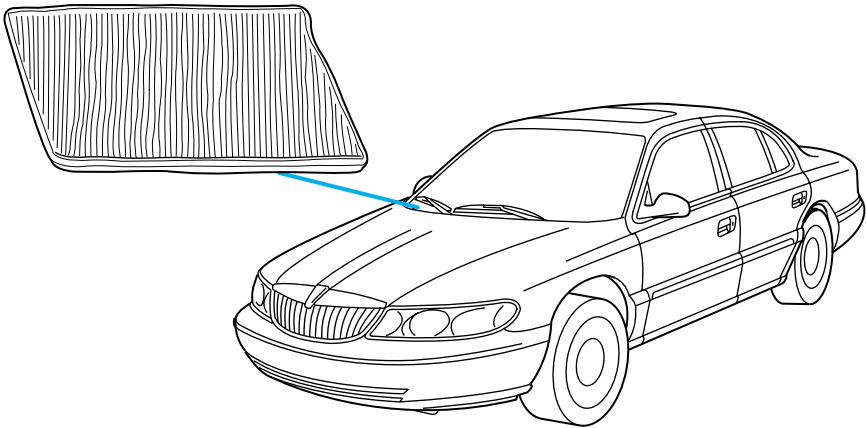

The cabin air filter restricts the entry of airborne dust and pollen particles. The filter is located just in front of the windshield under the cowl vent screen on the passenger side of the vehicle.

To replace the filter, perform the following procedure:

1. In order to gain better access to the filter, turn the ignition key to ON, then turn the wipers on. When the wipers reach the middle of the windshield (wipers in straight up position), turn the ignition to OFF.

Maintenance and care

2. Release and open the hood.

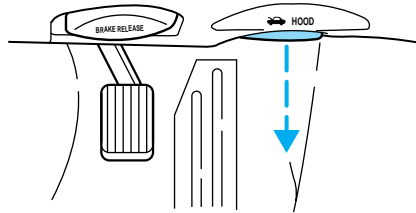

3. Pull the rubber cowl seal (number 1 in figure) away from the cowl vent screen. Remove the right half of the cowl vent screen (number 2 in figure) by placing your hand underneath the cowl vent screen and lifting straight up to release the four spring clips.

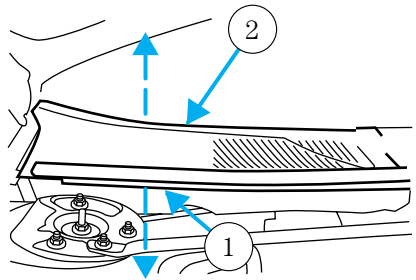

4. Remove the water shield (number 3 in figure) by disengaging the two water shield locking tabs (number 4 in figure), then sliding the water shield toward the front of the vehicle. After the locking tabs are disengaged from the water shield, lift the water shield up and away from the vehicle.

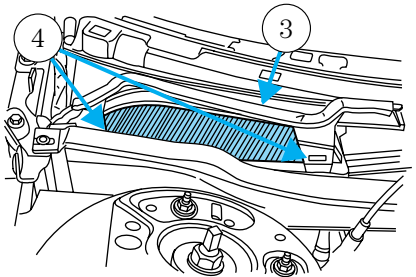

5. Remove the filter. Reverse the procedure to install the new filter.

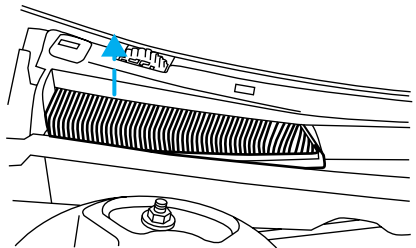

Maintenance and care

Be careful when installing the new filter. Avoid bending or tearing the filter and make sure it is fully seated in its mounting location after installation.

WINDSHIELD WIPER BLADES

Check the wiper blades at least twice a year or when they seem less effective. Substances such as tree sap and some hot wax treatments used by commercial car washes reduce the effectiveness of wiper blades.

Checking the wiper blades

If the wiper blades do not wipe properly, clean both the windshield and wiper blades using undiluted windshield wiper solution or a mild detergent. Rinse thoroughly with clean water. To avoid damaging the blades, do not use fuel, kerosene, paint thinner or other solvents.

Changing the wiper blades

To replace the wiper blades:

1. Pull the wiper arm away from the windshield and lock into the service position.
2. Turn the blade at an angle from the wiper arm. Push the lock pin manually to release the blade and pull the wiper blade down toward the windshield to remove it from the arm.
3. Attach the new wiper to the wiper arm and press it into place until a click is heard.

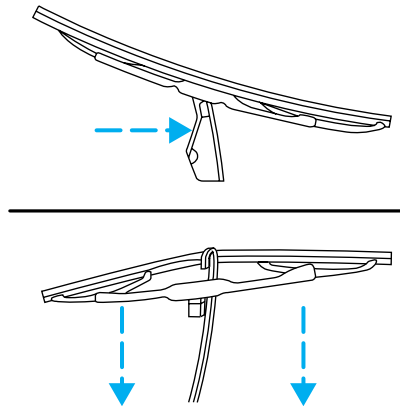

SECURITIRE (IF EQUIPPED)

SecuriTires are designed to allow you to continue driving your vehicle a limited number of miles when one of your vehicle's tires is at low or even zero air pressure.

At zero pressure, the SecuriTires will provide you with a minimum driving capability of approximately 30 km (20 miles). How you drive and

Maintenance and care

the actual amount of air pressure left in your tires will determine exactly how many miles can be driven.

To extend the mileage and help prevent damage to low or deflated tires:

- do not exceed 90 km/h (55 mph). Drive at a reduced rate of speed, if possible.
- avoid excessive hard steering and braking maneuvers, if possible.
- stop periodically to allow the tires to cool down.

Pressure alert system

Each of your SecuriTires is monitored by a low tire pressure sensor. A warning will appear in the overhead console when the pressure in one of your tires drops below acceptable levels or if the system has malfunctioned.

This device complies with Part 15 of the FCC rules and with RS-210 of Industry Canada. Operation is subject to the following two conditions: (1) This device may not cause harmful interference, and (2) This device must accept any interference received, including interference that may cause undesired operation.

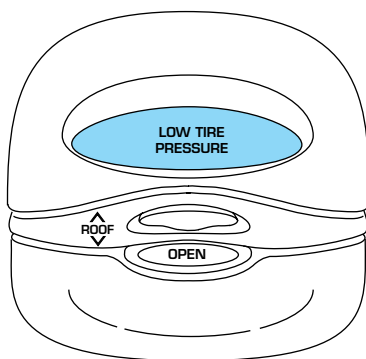

Maintenance warning

The LOW TIRE PRESSURE warning will illuminate and stay on when one of your vehicle's tires drops below 124 kPa (18 psi). The warning light will also come on and stay lit if the Pressure Alert System has malfunctioned.

If this warning appears, check the pressure in your tires as soon as possible and adjust any tire that is low to the recommended air pressure level.

If the warning remains on after you have adjusted the tires to the recommended air pressure levels, take your vehicle to an authorized Lincoln/Mercury dealer for service.

Maintenance and care

Flat tire warning

If the sensors detect a tire pressure lower than 68 kPa (10 psi), the LOW TIRE PRESSURE warning will appear in the overhead console and the message WARNING LOW TIRE PRESSURE will be displayed in the message center, indicating an impending flat tire. If this condition occurs, your SecuriTire requires service as soon as possible. Refer to *Servicing your SecuriTires*.

The Pressure Alert System will activate only when the vehicle is moving faster than 15 km/h (10 mph).

Servicing your SecuriTires

If you cannot service your SecuriTire immediately, replace it with your temporary spare as soon as safely possible.

Your temporary spare tire can be used until your SecuriTire has been repaired.

It is recommended that you always have your SecuriTires serviced by an authorized Michelin tire dealer. **Each SecuriTire is equipped with a pressure sensor around the wheel rim. This sensor could be damaged when removing and installing the tire.** Servicing a SecuriTire at locations other than your Michelin tire dealer may adversely affect your warranty.

If you have questions concerning your SecuriTires or servicing, please call the Michelin Tire Information Line at 1-800-847-3435 or contact your local Michelin tire dealer.

INFORMATION ABOUT UNIFORM TIRE QUALITY GRADING

New vehicles are fitted with tires that have a rating on them called Tire Quality Grades. The Quality grades can be found where applicable on the tire sidewall between tread shoulder and maximum section width. For example:

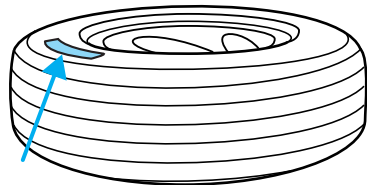

- **Treadwear 200 Traction AA Temperature A**

These Tire Quality Grades are determined by standards that the United States Department of Transportation has set.

Maintenance and care

Tire Quality Grades apply to new pneumatic tires for use on passenger cars. They do not apply to deep tread, winter-type snow tires, space-saver or temporary use spare tires, tires with nominal rim diameters of 10 to 12 inches or limited production tires as defined in Title 49 Code of Federal Regulations Part 575.104(c)(2).

U.S. Department of Transportation-Tire quality grades: The U.S. Department of Transportation requires Ford to give you the following information about tire grades exactly as the government has written it.

Treadwear

The treadwear grade is a comparative rating based on the wear rate of the tire when tested under controlled conditions on a specified government test course. For example, a tire graded 150 would wear one and one-half (1 1/2) times as well on the government course as a tire graded 100. The relative performance of tires depends upon the actual conditions of their use, however, and may depart significantly from the norm due to variations in driving habits, service practices, and differences in road characteristics and climate.

Traction AA A B C

The traction grades, from highest to lowest are AA, A, B, and C. Those grades represent the tire's ability to stop on wet pavement as measured under controlled conditions on specified government test surfaces of asphalt and concrete. A tire marked C may have poor traction performance.



The traction grade assigned to this tire is based on straight-ahead braking traction tests, and does not include acceleration, cornering, hydroplaning or peak traction characteristics.

Temperature A B C

The temperature grades are A (the highest), B, and C, representing the tire's resistance to the generation of heat and its ability to dissipate heat when tested under controlled conditions on a specified indoor laboratory test wheel. Sustained high temperature can cause the material of the tire to degenerate and reduce tire life, and excessive temperature can lead to sudden tire failure. The grade C corresponds to a level of performance which all passenger car tires must meet under the Federal Motor Vehicle Safety Standard No. 109. Grades B and A represent higher levels of performance on the laboratory test wheel than the minimum required by law.

Maintenance and care



The temperature grade for this tire is established for a tire that is properly inflated and not overloaded. Excessive speed, underinflation, or excessive loading, either separately or in combination, can cause heat buildup and possible tire failure.

SERVICING YOUR TIRES

Checking the tire pressure

- Use an accurate tire pressure gauge.
- Check the tire pressure when tires are cold, after the vehicle has been parked for at least one hour or has been driven less than 5 km (3 miles).
- Adjust tire pressure to recommended specifications found on the Certification Label.



Improperly inflated tires can affect vehicle handling and can fail suddenly, possibly resulting in loss of vehicle control.

Tire rotation

Because your vehicle's tires perform different jobs, they often wear differently. To make sure your tires wear evenly and last longer, rotate them as indicated in the Scheduled Maintenance Guide. If you notice that the tires wear unevenly, have them checked.

- Four tire rotation

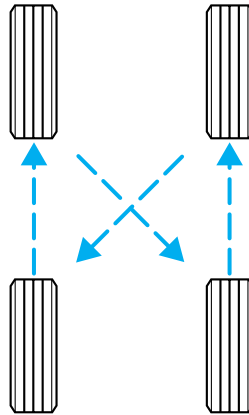

Maintenance and care

Replacing the tires

Replace the tires when the wear band is visible through the tire treads.

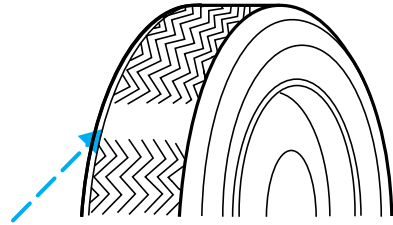

When replacing full size tires, never mix radial bias-belted, or bias-type tires. Use only the tire sizes that are listed on the Certification Label. Make sure that all tires are the same size, speed rating, and load-carrying capacity. Use only the tire combinations recommended on the label. If you do not follow these precautions, your vehicle may not drive properly and safely.



Make sure that all replacement tires are of the same size, type, load-carrying capacity and tread design (e.g., “All Terrain”, etc.), as originally offered by Ford.



Failure to follow these precautions may adversely affect the handling of the vehicle and make it easier for the driver to lose control and roll over.

Tires that are larger or smaller than your vehicle’s original tires may also affect the accuracy of your speedometer.

SNOW TIRES AND CHAINS



Driving too fast for conditions creates the possibility of loss of vehicle control. Driving at very high speeds for extended periods of time may result in damage to vehicle components.

Maintenance and care



Snow tires must be the same size and grade as the tires you currently have on your vehicle.

Do not use any type of tire chains on this vehicle. This includes both conventional and cable-type chains.

The tires on your vehicle have all-weather treads that provide traction in rain or snow. However, during the winter months in some climates, you may need to use snow tires.

WHAT YOU SHOULD KNOW ABOUT AUTOMOTIVE FUELS

Important safety precautions



Do not overfill the fuel tank. The pressure in an overfilled tank may cause leakage and lead to fuel spray and fire.



The fuel system may be under pressure. If the fuel filler cap is venting vapor or if you hear a hissing sound, wait until it stops before completely removing the fuel filler cap. Otherwise, fuel may spray out and injure you or others.



If you do not use the proper fuel filler cap, excessive pressure or vacuum in the fuel tank may damage the fuel system or cause the fuel system to work improperly in a collision, which may result in possible personal injury.



Automotive fuels can cause serious injury or death if misused or mishandled.



Gasoline may contain benzene, which is a cancer-causing agent.

Maintenance and care

Observe the following guidelines when handling automotive fuel:

- Extinguish all smoking materials and any open flames before fueling your vehicle.
- Always turn off the vehicle before fueling.
- Automotive fuels can be harmful or fatal if swallowed. Fuel such as gasoline is highly toxic and if swallowed can cause death or permanent injury. If fuel is swallowed, call a physician immediately, even if no symptoms are immediately apparent. The toxic effects of fuel may not be visible for hours.
- Avoid inhaling fuel vapors. Inhaling too much fuel vapor of any kind can lead to eye and respiratory tract irritation. In severe cases, excessive or prolonged breathing of fuel vapor can cause serious illness and permanent injury.
- Avoid getting fuel liquid in your eyes. If fuel is splashed in the eyes, remove contact lenses (if worn), flush with water for 15 minutes and seek medical attention. Failure to seek proper medical attention could lead to permanent injury.
- Fuels can also be harmful if absorbed through the skin. If fuel is splashed on the skin and/or clothing, promptly remove contaminated clothing and wash skin thoroughly with soap and water. Repeated or prolonged skin contact with fuel liquid or vapor causes skin irritation.
- Be particularly careful if you are taking “Antabuse” or other forms of disulfiram for the treatment of alcoholism. Breathing gasoline vapors, or skin contact could cause an adverse reaction. In sensitive individuals, serious personal injury or sickness may result. If fuel is splashed on the skin, promptly wash skin thoroughly with soap and water. Consult a physician immediately if you experience an adverse reaction.



When refueling always shut the engine off and never allow sparks or open flames near the filler neck. Never smoke while refueling. Fuel vapor is extremely hazardous under certain conditions. Care should be taken to avoid inhaling excess fumes.

Maintenance and care



The flow of fuel through a fuel pump nozzle can produce static electricity, which can cause a fire if fuel is pumped into an ungrounded fuel container.

Use the following guidelines to avoid static build-up when filling an ungrounded fuel container:

- Place approved fuel container on the ground.
- DO NOT fill a fuel container while it is in the vehicle.
- Keep the fuel pump nozzle in contact with the fuel container while filling.
- DO NOT use a device that would hold the fuel pump handle in the fill position.

Fuel Filler Cap

Your fuel tank filler cap has an indexed design with a 1/8 turn on/off feature.

When fueling your vehicle:

1. Turn the engine off.
2. Carefully turn the filler cap counterclockwise 1/8 of a turn until it stops.
3. Pull to remove the cap from the fuel filler pipe.
4. To install the cap, align the tabs on the cap with the notches on the filler pipe.
5. Turn the filler cap clockwise 1/8 of a turn until it stops.

If the “Service Engine Soon/Check Engine” indicator comes on and stays on when you start the engine, the fuel filler cap may not be properly installed. Turn off the engine, remove the fuel filler cap, align the cap properly and reinstall it.

If you must replace the fuel filler cap, replace it with a fuel filler cap that is designed for your vehicle. The customer warranty may be void for any damage to the fuel tank or fuel system if the correct genuine Ford or Motorcraft fuel filler cap is not used.

Maintenance and care



The fuel system may be under pressure. If the fuel filler cap is venting vapor or if you hear a hissing sound, wait until it stops before completely removing the fuel filler cap. Otherwise, fuel may spray out and injure you or others.



If you do not use the proper fuel filler cap, excessive pressure or vacuum in the fuel tank may damage the fuel system or cause the fuel system to work improperly in a collision, which may result in possible personal injury.

Choosing the right fuel

Use only UNLEADED FUEL. The use of leaded fuel is prohibited by law and could damage your vehicle.

Do not use fuel containing methanol. It can damage critical fuel system components.

Your vehicle was not designed to use fuel or fuel additives with metallic compounds, including manganese-based compounds containing MMT.

Repairs to correct the effects of using a fuel for which your vehicle was not designed may not be covered by your warranty.

Octane recommendations

Your vehicle is designed to use “Premium” unleaded gasoline with an (R+M)/2 octane rating of 91 or higher for optimum performance.

The use of gasolines with lower

octane ratings may degrade performance. We do not recommend the use of gasolines labeled as “Premium” in high altitude areas that are sold with octane ratings of less than 91.

Do not be concerned if your engine sometimes knocks lightly. However, if it knocks heavily under most driving conditions while you are using fuel with the recommended octane rating, see your dealer or a qualified service technician to prevent any engine damage.

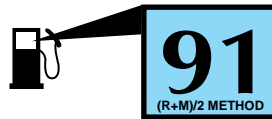

Fuel quality

If you are experiencing starting, rough idle or hesitation driveability problems during a cold start, try a different brand of “Premium”

Maintenance and care

unleaded gasoline. If the problems persist, see your dealer or a qualified service technician.

It should not be necessary to add any aftermarket products to your fuel tank if you continue to use high quality fuel of the recommended octane rating. Aftermarket products could cause damage to the fuel system. Repairs to correct the effects of using an aftermarket product in your fuel may not be covered by your warranty.

Many of the world's automakers issued the World-wide Fuel Charter that recommends gasoline specifications to provide improved performance and emission control system protection for your vehicle. Gasolines that meet the World-wide Fuel Charter should be used when available. Ask your fuel supplier about gasolines that meet the World-wide Fuel Charter.

Cleaner air

Ford approves the use of reformulated “cleaner-burning” gasolines to improve air quality. These gasolines may contain oxygenates up to 10% ethanol or 15% MTBE.

Running out of fuel

Avoid running out of fuel because this situation may have an adverse affect on powertrain components.

If you have run out of fuel:

- You may need to cycle the ignition from OFF to ON several times after refueling, to allow the fuel system to pump the fuel from the tank to the engine.
- Your “Service Engine Soon” indicator may come on. For more information on the “Service Engine Soon” indicator, refer to the *Instrumentation* chapter.

Fuel Filter

For fuel filter replacement, see your dealer or a qualified service technician. Refer to the Scheduled Maintenance Guide for the appropriate intervals for changing the fuel filter.

Replace the fuel filter with an authorized Motorcraft part. The customer warranty may be void for any damage to the fuel system if an authorized Motorcraft fuel filter is not used.

Maintenance and care

ESSENTIALS OF GOOD FUEL ECONOMY

Measuring techniques

Your best source of information about actual fuel economy is you, the driver. You must gather information as accurately and consistently as possible. Fuel expense, frequency of fillups or fuel gauge readings are NOT accurate as a measure of fuel economy. We do not recommend taking fuel economy measurements during the first 1 600 km (1 000 miles) of driving (engine break-in period). You will get a more accurate measurement after 3 000 km–5 000 km (2 000 miles–3 000 miles).

Filling the tank

The advertised fuel capacity of the fuel tank on your vehicle is equal to the rated refill capacity of the fuel tank as listed in the *Refill Capacities* section of the *Capacities and specifications* chapter.

The advertised capacity is the amount of the indicated capacity and the empty reserve combined. Indicated capacity is the difference in the amount of fuel in a full tank and a tank when the fuel gauge indicates empty. Empty reserve is the small amount of usable fuel remaining in the fuel tank after the fuel gauge indicates empty.

The amount of empty reserve varies and should not be relied upon to increase driving range. When refueling your vehicle after the fuel gauge indicates empty, you might not be able to refuel the full amount of the advertised capacity of the fuel tank due to the empty reserve still present in the tank.

For consistent results when filling the fuel tank:

- Use the same filling rate setting (low — medium — high) each time the tank is filled.
- Allow three automatic click-offs when filling.
- Always use fuel with the recommended octane rating.
- Use a known quality gasoline, preferably a national brand.
- Use the same side of the same pump and have the vehicle facing the same direction each time you fill up.
- Have the vehicle loading and distribution the same every time.

Your results will be most accurate if your filling method is consistent.

Maintenance and care

Calculating fuel economy

1. Fill the fuel tank completely and record the initial odometer reading (in kilometers or miles).
2. Each time you fill the tank, record the amount of fuel added (in liters or gallons).
3. After at least three to five tank fill-ups, fill the fuel tank and record the current odometer reading.
4. Subtract your initial odometer reading from the current odometer reading.
5. Follow one of the simple calculations in order to determine fuel economy:

Multiply liters used by 100, then divide by total kilometers traveled.

Divide total miles traveled by total gallons used.

Keep a record for at least one month and record the type of driving (city or highway). This will provide an accurate estimate of the vehicle's fuel economy under current driving conditions. Additionally, keeping records during summer and winter will show how temperature impacts fuel economy. In general, lower temperatures give lower fuel economy.

Driving style — good driving and fuel economy habits

Give consideration to the lists that follow and you may be able to change a number of variables and improve your fuel economy.

Habits

- Smooth, moderate operation can yield up to 10% savings in fuel.
- Steady speeds without stopping will usually give the best fuel economy.
- Idling for long periods of time (greater than one minute) may waste fuel.
- Anticipate stopping; slowing down may eliminate the need to stop.
- Sudden or hard accelerations may reduce fuel economy.
- Slow down gradually.
- Driving at reasonable speeds (traveling at 88 km/h [55 mph] uses 15% less fuel than traveling at 105 km/h [65 mph]).
- Revving the engine before turning it off may reduce fuel economy.

Maintenance and care

- Using the air conditioner or defroster may reduce fuel economy.
- You may want to turn off the speed control in hilly terrain if unnecessary shifting between third and fourth gear occurs. Unnecessary shifting of this type could result in reduced fuel economy.
- Warming up a vehicle on cold mornings is not required and may reduce fuel economy.
- Resting your foot on the brake pedal while driving may reduce fuel economy.
- Combine errands and minimize stop-and-go driving.

Maintenance

- Keep tires properly inflated and use only recommended size.
- Operating a vehicle with the wheels out of alignment will reduce fuel economy.
- Use recommended engine oil. Refer to *Lubricant Specifications*.
- Perform all regularly scheduled maintenance items. Follow the recommended maintenance schedule and owner maintenance checks found in your vehicle Scheduled Maintenance Guide.

Conditions

- Heavily loading a vehicle or towing a trailer may reduce fuel economy at any speed.
- Carrying unnecessary weight may reduce fuel economy (approximately 0.4 km/L [1 mpg] is lost for every 180 kg [400 lb] of weight carried).
- Adding certain accessories to your vehicle (for example bug deflectors, rollbars/light bars, running boards, ski/luggage racks) may reduce fuel economy.
- Using fuel blended with alcohol may lower fuel economy.
- Fuel economy may decrease with lower temperatures during the first 12–16 km (8–10 miles) of driving.
- Driving on flat terrain offers improved fuel economy as compared to driving on hilly terrain.
- Transmissions give their best fuel economy when operated in the top cruise gear and with steady pressure on the gas pedal.
- Close windows for high speed driving.

Maintenance and care

EPA window sticker

Every new vehicle should have the EPA window sticker. Contact your dealer if the window sticker is not supplied with your vehicle. The EPA window sticker should be your guide for the fuel economy comparisons with other vehicles.

It is important to note the box in the lower left corner of the window sticker. These numbers represent the Range of L/100 km (MPG) expected on the vehicle under optimum conditions. Your fuel economy may vary depending upon the method of operation and conditions.

EMISSION CONTROL SYSTEM

Your vehicle is equipped with various emission control components and a catalytic converter which will enable your vehicle to comply with applicable exhaust emission standards. To make sure that the catalytic converter and other emission control components continue to work properly:

- Use only the specified fuel listed.
- Avoid running out of fuel.
- Do not turn off the ignition while your vehicle is moving, especially at high speeds.
- Have the items listed in your Scheduled Maintenance Guide performed according to the specified schedule.

The scheduled maintenance items listed in the Scheduled Maintenance Guide are essential to the life and performance of your vehicle and to its emissions system.

If other than Ford, Motorcraft or Ford-authorized parts are used for maintenance replacements or for service of components affecting emission control, such non-Ford parts should be equivalent to genuine Ford Motor Company parts in performance and durability.



Do not park, idle, or drive your vehicle in dry grass or other dry ground cover. The emission system heats up the engine compartment and exhaust system, which can start a fire.

Illumination of the “Service Engine Soon” light, charging system warning light or the temperature warning light, fluid leaks, strange odors, smoke or loss of engine power, could indicate that the emission control system is not working properly.

Maintenance and care



Exhaust leaks may result in entry of harmful and potentially lethal fumes into the passenger compartment.

Do not make any unauthorized changes to your vehicle or engine. By law, vehicle owners and anyone who manufactures, repairs, services, sells, leases, trades vehicles, or supervises a fleet of vehicles are not permitted to intentionally remove an emission control device or prevent it from working. Information about your vehicle's emission system is on the Vehicle Emission Control Information Decal located on or near the engine. This decal identifies engine displacement and gives some tune up specifications.

Please consult your "Warranty Guide" for complete emission warranty information.

Readiness for Inspection/Maintenance (I/M) testing

In some localities, it may be a legal requirement to pass an I/M test of the on-board diagnostics system. If your "Check Engine/Service Engine Soon" light is on, refer to the description in the *Warning Lights and Chimes* section of the *Instrumentation* chapter. Your vehicle may not pass the I/M test with the "Check Engine/Service Engine Soon" light on.

If the vehicle's powertrain system or its battery has just been serviced, the on-board diagnostics system is reset to a "not ready for I/M test" condition. To ready the on-board diagnostics system for I/M testing, a minimum of 30 minutes of city and highway driving is necessary as described below:

- First, at least 10 minutes of driving on an expressway or highway.
- Next, at least 20 minutes driving in stop-and-go, city-type traffic with at least four idle periods.

Allow the vehicle to sit for at least eight hours without starting the engine. Then, start the engine and complete the above driving cycle. The engine must warm up to its normal operating temperature. Once started, do not turn off the engine until the above driving cycle is complete.

REPLACING EXTERIOR BULBS

Check the operation of the following lamps frequently:

- Headlamps
- Tail lamps

Maintenance and care

- Brakelamps
- High-mount brakelamp
- Turn signals
- Backup lamps
- License plate lamp

Do not remove lamp bulbs unless they will be replaced immediately. If a bulb is removed for an extended period of time, contaminants may enter the lamp housings and affect performance.

Replacing headlamp bulbs

To remove the headlamp bulb:

1. Make sure headlamp switch is in OFF position.
2. Lift the hood and remove the protective cover from the top of the headlamps by lifting up on the rear corners and release the velcro attachments. Lift the cover and pull towards the windshield.
3. At the back of the headlamp, pull back slightly and up on the two retainer pins to release the headlamp assembly from the vehicle and pull headlamp forward.

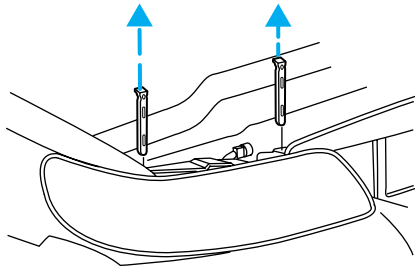

4. Remove the protective dust shield from the housing by turning the dust shield counterclockwise (when viewed from the rear).

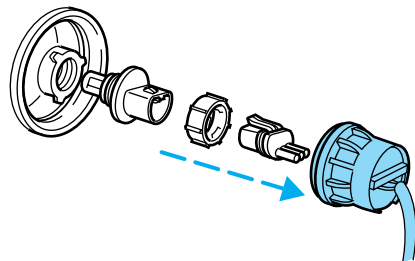

Maintenance and care

5. Disconnect the electrical connector from the bulb by pulling rearward.

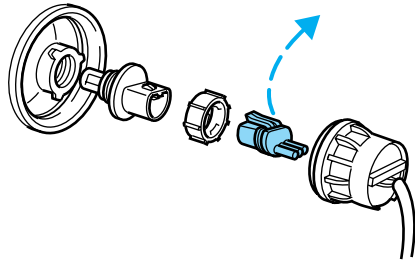

6. Remove the bulb retaining ring by rotating it counterclockwise.

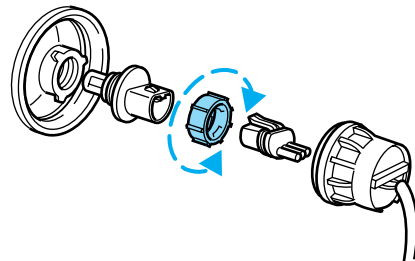

7. Remove the old bulb from the lamp assembly by pulling it straight out of the lamp assembly.

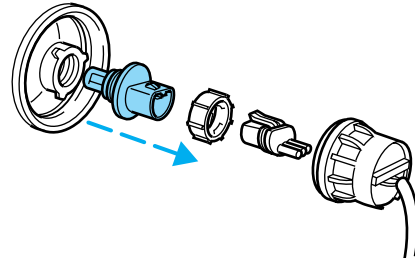

To install the new bulb:



Handle a halogen headlamp bulb carefully and keep out of children's reach. Grasp the bulb only by its plastic base and do not touch the glass. The oil from your hand could cause the bulb to break the next time the headlamps are operated.

1. Install the new bulb in lamp assembly by pushing straight in with the bulb's plastic base facing upward. You may need to turn the bulb slightly to align the grooves in the plastic base with the tabs in the lamp assembly.

Maintenance and care

2. Install the bulb retaining ring over the plastic base and lock the ring by rotating clockwise until it snaps into place.
3. Connect the electrical connector to the bulb.
4. Install the protective dust shield and lock the shield by rotating it clockwise until it locks into position.
5. Carefully position the headlamp assembly onto the vehicle making sure the alignment pins are inserted into the proper holes.
6. Hold the headlamp assembly snugly against the vehicle and push down on the retainer pins to lock the lamp into place.
7. Before reinstalling the protective cover, make sure the cover tabs are fully seated under the grille molding.
8. Turn the headlamps on and make sure they work properly. If the headlamp was correctly aligned before you changed the bulb, you should not need to align it again.

Replacing front parking lamp/turn signal/cornering lamp bulbs

1. Make sure the headlamp control is in the OFF position.
2. Open the hood and remove the protective cover from the top of the headlamps by lifting up on the rear corners and release the velcro attachments. Lift the cover and pull towards the windshield.
3. At the back of the headlamp, pull back and up slightly on the two retainer pins to release the headlamp assembly from the vehicle and pull headlamp forward.

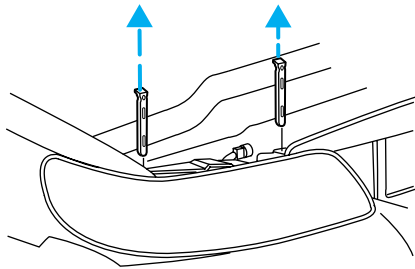

Maintenance and care

4. Rotate the bulb socket counterclockwise and remove from lamp assembly.
5. Carefully pull bulb straight out of the socket and push in the new bulb.
6. To complete installation, follow the removal procedure in reverse order.

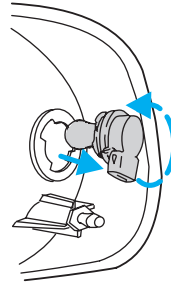

Replacing license plate lamp bulbs

1. Remove two screws, grommets and the license plate lamp assembly from the trunk lid.
2. Carefully pull the bulb from the socket and push in the new bulb.
3. Install the lamp assembly on trunk lid with two grommets, ensuring the grommets are pushed all the way in to the trunk lid and secure with two screws.

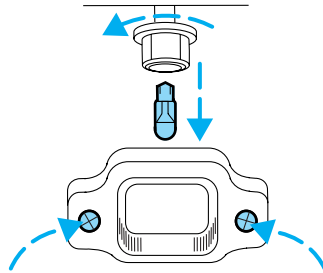

Replacing backup lamp bulbs

For bulb replacement, see a dealer or qualified technician.

Replacing high-mount brakelamp bulbs

For bulb replacement, see a dealer or qualified technician.

Replacing tail lamp/turn lamp bulbs

For bulb replacement, see a dealer or qualified technician.

Replacing the interior bulbs

Check the operation of the following interior bulbs frequently:

- interior overhead lamp
- map lamp

For bulb replacement, see a dealer or qualified technician.

Maintenance and care

Using the right bulbs

Replacement bulbs are specified in the chart below. Headlamp bulbs must be marked with an authorized “D.O.T.” for North America and an “E” for Europe to assure lamp performance, light brightness and pattern and safe visibility. The correct bulbs will not damage the lamp assembly or void the lamp assembly warranty and will provide quality bulb burn time.

Function	Trade Number
Headlamp	9007
Cornering lamp (front)	3156K
Backup lamp	3457K
High-mount brakelamp	912
Park/turn lamp (front)	3157K
License plate lamp	168
Luggage compartment lamp (decklid ajar)	912
Side marker (front)	194NA (amber)
Side marker (rear)	916
Stoplamp and tail lamp	3157K
Redundant turn lamp (rear)	3157K
Glovebox lamp	194
Ash receptacle	1445
Ash tray (rear)	37
Cigar lighter (console)	1893
Door mounted lamp (front)	214-2
Illuminated visor mirror	74
Overhead console reading lamp (without moon roof)	912
Passenger assist handle (rear seat)	211-2
All replacement bulbs are clear in color except where noted.	
To replace all instrument panel lights - see your dealer.	

AIMING THE HEADLAMPS

Your vehicle is equipped with a Vehicle Headlamp Aim Device (VHAD) on each headlamp. Each headlamp may be properly aimed in the vertical (up/down) and the horizontal (left/right) directions using your VHAD system. The headlamps on your vehicle are properly aimed at the assembly plant.

Maintenance and care

A bubble (vertical indicator) that is not centered between the two red lines does not necessarily indicate out-of-aim headlamps. If your vehicle is not positioned on a level surface, the slope will be included in the vertical indication. Therefore, vertical and horizontal headlamp adjustment should be performed only when the beam direction appears to be incorrect.

You will need one 4 mm wrench or socket to make the adjustments.

If the vehicle has been in an accident, the vehicle's front structure should be properly aligned before aiming the headlamps.

Horizontal aim adjustment

1. Park the vehicle on a level surface.
2. With the hood open, remove the protective cover, locate the horizontal indicator and the adjusting screw at the rear of the headlamp assembly.

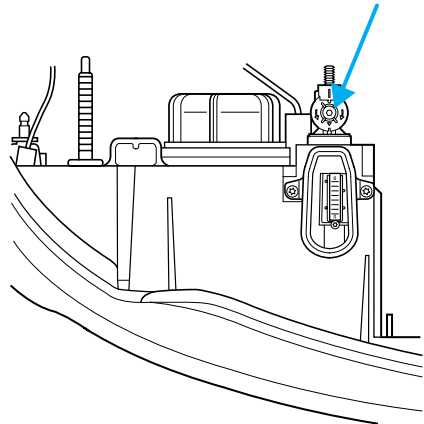

3. Use a 4 mm wrench or socket to turn the horizontal adjusting screw until the "0" mark on the yellow dial lines up with the reference mark on the marker (as shown) when viewed directly from above.

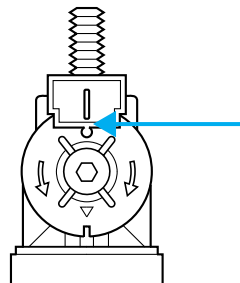

Maintenance and care

Turning the horizontal adjusting screw in the direction of the arrow changes the horizontal aim as shown.

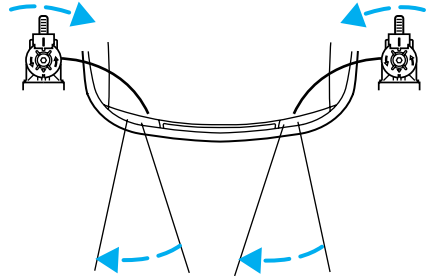

Vertical aim adjustment

1. Park the vehicle on a level surface.
2. With the hood open, remove the protective cover, then locate the bubble level and the vertical adjustment screw. The adjustment screw is located on the outboard side of the headlamp.

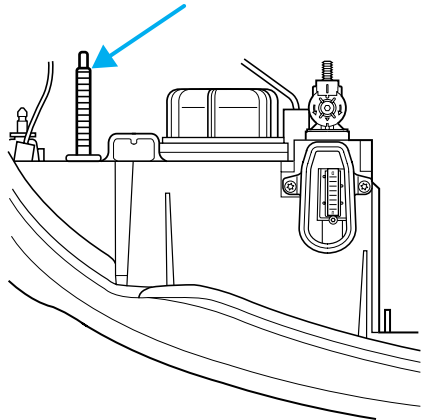

3. The “U” and “D” on the bubble indicate the directional change (up or down) of the vertical aim.
4. Use a 4 mm wrench or socket to turn the vertical adjusting screw until the bubble is centered between the two red lines which represents the “0” mark position.

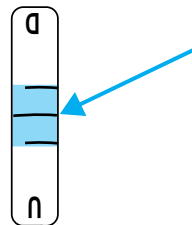

When the horizontal and vertical indicators are set to the “0” mark, the headlamp has been properly aimed.

5. Install the protective cover.

Maintenance and care

CLEANING AND CARING FOR YOUR VEHICLE

Refer to the Customer Assistance chapter for a list of Ford-approved cleaners, polishes and waxes.

Washing your vehicle

Wash your vehicle regularly with cold or lukewarm water. Never use strong detergents or soap. If your vehicle is particularly dirty, use a quality car wash detergent. Always use a clean sponge, washing glove or similar device and plenty of water for best results. To avoid spots, avoid washing when the hood is still warm, immediately after or during exposure to strong sunlight.

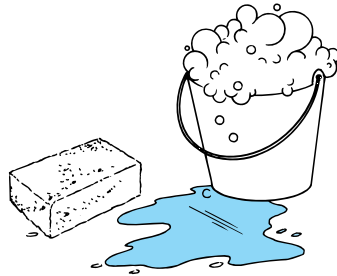

During winter months, it is especially important to wash the vehicle on a regular basis. Large quantities of dirt and road salt are difficult to remove and also cause damage to the vehicle.

Any gasoline spilled on the vehicle or deposits such as bird droppings should be washed and sponged off as soon as possible. Deposits not removed promptly can cause damage to the vehicle's paintwork.

Remove any exterior accessories, such as antennas, before entering a car wash. If you have wax applied to the vehicle at a commercial car wash, it is recommended that you clean the wiper blades and windshield as described in *Cleaning the wiper blades and windshield*.

After washing, apply the brakes several times to dry them.

Waxing your vehicle

Waxing your vehicle on a regular basis will reduce minor scratches and paint damage.

Wax when water stops beading on the surface. This could be every three or four months, depending on operating conditions.

Use only carnauba or synthetic-based waxes. Use a cleaning fluid with a clean cloth to remove any bugs before waxing your vehicle. Use tar remover to remove any tar spots.

Avoid getting wax on the windshield, or on any surfaces which appear coarse or bumpy. If you have wax applied at a commercial car wash, it is

Maintenance and care

recommended that you clean the wiper blades and windshield as described in *Cleaning the wiper blades and windshield*.

Repairing paint chips

Minor scratches or paint damage from road debris may be repaired with the Ultra Touch Prep and Finishing Kit (#F7AZ-19K507-BA), Lacquer Touch-up Paint (#ALBZ-19500-XXXXA), or Exterior Acrylic Spray Lacquer (#ALAZ-19500-XXXXA) from the Ford Car Care Chemicals line. Please note that the part numbers (shown as XXXX above) will vary with your vehicle's specific coloring. Observe the application instructions on the products.

Remove particles such as bird droppings, tree sap, insect remains, tar spots, road salt and industrial fallout immediately.

Cleaning the wheels

Wash with the same detergent as the body of your vehicle. Do not use acid-based or alcohol-based wheel cleaners, steel wool, fuel or strong detergents. Never use abrasives that will damage the finish of special wheel surfaces. Use a tar remover to remove grease and tar.

The brushes used in some automatic car washes may damage the finish on your wheels. Before going to a car wash, find out if the brushes are abrasive.

Cleaning non-painted plastic exterior parts

Use vinyl cleaner for routine cleaning. Clean with a tar remover if necessary. Do not clean plastic parts with thinners, solvents or petroleum-based cleaners.

Underbody

Flush the complete underside of vehicle frequently. Keep body drain holes unplugged. Inspect for road damage.

Cleaning mirrors

Do not clean your mirrors with a dry cloth or abrasive materials. Use a soft cloth and mild detergent and water. Be careful when removing ice from outside mirrors because you may damage the reflective surface.

Maintenance and care

Cleaning the exterior lamps

Wash with the same detergent as the exterior of your vehicle. If necessary, use a tar remover such as Ford Extra Strength Tar and Road Oil Remover (B7A-19520-AA).

To avoid scratching the lamps, do not use a dry paper towel, chemical solvents or abrasive cleaners.

Cleaning the wiper blades, windshield and rear window

If the wiper blades do not wipe properly, clean the wiper blade rubber element with undiluted windshield washer solution or a mild detergent. To avoid damaging the blades, do not use fuel, kerosene, paint thinner or other solvents.

If the wiper still does not wipe properly, this could be caused by substances on the windshield or rear window such as tree sap and some hot wax treatments used by commercial car washes. Clean the outside of the windshield or rear window with a non-abrasive cleaner such as Ford Ultra-Clear Spray Glass Cleaner, (E4AZ-19C507-AA), available from your Ford Dealer. **Do not** use abrasive cleansers on glass as they may cause scratches. The windshield or rear window is clean if beads do not form when you rinse it with water. The windshield, rear window and wiper blades should be cleaned on a regular basis, and blades or rubber elements replaced when worn.

Cleaning the engine

Engines are more efficient when they are clean because grease and dirt buildup keep the engine warmer than normal. When washing:

- Take care when using a power washer to clean the engine. The high pressure fluid could penetrate the sealed parts and cause damage.
- Do not spray with cold water to avoid cracking the engine block or other engine components.
- Never apply anything to the drive belt (including belt dressing).

Maintenance and care

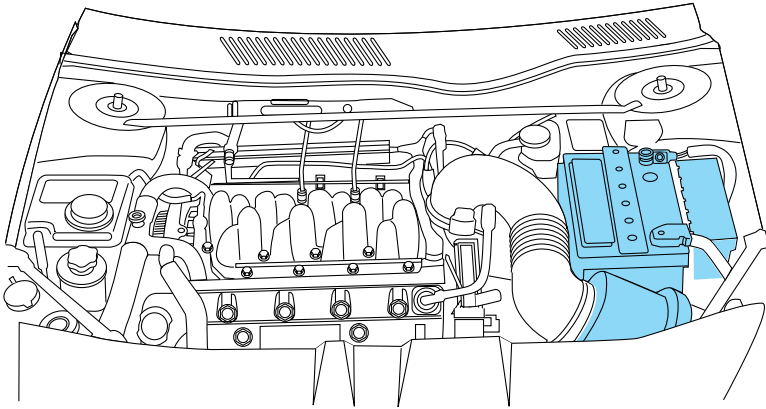

- Cover the highlighted areas to prevent water damage when cleaning the engine.
- Never wash or rinse the engine while it is running; water in the running engine may cause internal damage.

Cleaning the instrument panel

Clean with a damp cloth, then dry with a dry cloth.

Avoid cleaner or polish that increases the gloss of the upper portion of the instrument panel. The dull finish in this area helps protect the driver from undesirable windshield reflection.



Do not use chemical solvents or strong detergents when cleaning the steering wheel or instrument panel to avoid contamination of the air bag system.

Cleaning the instrument cluster lens

Clean with a damp cloth, then dry with a dry cloth.

Do not use household or glass cleaners as these may damage the lens.

Cleaning seats equipped with side air bags

Remove dust and loose dirt with a whisk broom or a vacuum cleaner. Remove fresh spots immediately. Follow the directions that come with the cleaner. Do not saturate the seat cover with upholstery cleaner.

Maintenance and care



Do not use chemical solvents or strong detergents when cleaning the seat mounted side air bag. Such products could contaminate the side air bag system and affect performance of the side air bag in a collision.

Woodtone trim

Wipe stains with a soft cloth and a multi-purpose cleaning solution.

Inside windows

Use Ultra-Clear Spray Glass Cleaner (E4AZ-19C507-AA) for the inside windows if they become fogged.

Cleaning and maintaining the safety belts

Clean the safety belts with a mild soap solution recommended for cleaning upholstery or carpets. Do not bleach or dye the belts, because these actions may weaken the belt webbing.

Check the safety belt system periodically to make sure there are no nicks, wear or cuts. If your vehicle has been involved in an accident, refer to the *Safety belt maintenance* section in the *Seating and safety restraints* chapter.

Cleaning leather seats (if equipped)

To clean, simply use a soft cloth dampened with water and a mild soap. Wipe the leather again with a damp cloth to remove soap residue. Dry with a soft cloth. For tougher soiling concerns, Ford recommends using the Deluxe Leather Care Kit F8AZ-19G253-AA, which is available from your Ford Dealer. This mild cleaner and special pad, cleans the leather and maintains its natural beauty. Follow the instructions on the cleaner label. Regular cleaning of your leather upholstery helps maintain its resiliency and color.

Do not use household cleaning products, alcohol solutions, solvents or cleaners intended for rubber, vinyl or plastics.

Cleaning the interior fabric

Remove dust and loose dirt with a whisk broom or a vacuum cleaner. Remove fresh spots immediately. Do not use household or glass cleaners. These agents can stain and discolor the fabric. Use a mild soap and water solution if necessary.

Capacities and specifications

MOTORCRAFT PART NUMBERS

Component	4.6L DOHC V8 engine
Engine air filter element	FA-1615
Cabin Air filter element	FP-5
Fuel filter	FG-800A
Battery	BXT-65-750
Oil filter	FL-820-S
PCV valve	EV-111
Spark plugs*	AWSF-32E

* Refer to Vehicle Emissions Control Information (VECI) decal for spark plug gap information.

REFILL CAPACITIES

Fluid	Ford Part Name	Application	Capacity
Engine oil (includes filter change)	Motorcraft SAE 5W-30 Super Premium Motor Oil	All	5.7L (6.0 quarts)
Engine coolant ¹	Premium Engine Coolant	All	15.0L (15.8 quarts)
Brake fluid	²	All	Fill to line on reservoir
Power steering fluid	Motorcraft MERCON® ATF	All	Fill to line on reservoir
Fuel tank	N/A	All	75.7L (20.0 gallons)
Automatic transaxle	Motorcraft MERCON®V ATF	All	13.0L (13.7 quarts)
Windshield washer fluid	Ultra-Clear Windshield Washer Concentrate	All	3.4L (3.6 quarts)

Capacities and specifications

¹ Use Ford Premium Engine Coolant (green in color). DO NOT USE Ford Extended Life Engine Coolant (orange in color). Refer to *Adding engine coolant, in the Maintenance and Care chapter*.

² Use only brake fluids certified to meet Ford specifications. Refer to *Lubricant Specifications* in this chapter. DOT 3 fluid is recommended. However, if DOT 3 is not available, DOT 4 fluid can be used.

LUBRICANT SPECIFICATIONS

Item	Ford Part Name or equivalent	Ford Part Number	Ford Specification
Brake fluid	High Performance DOT 3 Motor Vehicle Brake Fluid ¹	C6AZ-19542-AB	ESA-M6C25-A and DOT 3
Hinges, latches, stricker plates, fuel filler door hinge and seat tracks	Multi-Purpose Grease	DOAZ-19584-AA or F5AZ-19G209-AA	ESB-M1C93-B or ESR-M1C159-A
Lock cylinders	Penetrating and Lock Lubricant	E8AZ-19A501-B	none
Automatic transaxle (AX4N)	Motorcraft MERCON®V ATF	XT-5-QM	MERCON®V
Engine oil	Motorcraft SAE 5W-30 Super Premium Motor Oil	XO-5W30-QSP	WSS-M2C153-G and API Certification Mark
Constant velocity joints	CV Joint Grease (High Temp.)	E43Z-19590-A	ESP-M1C207-A
Engine coolant	Ford Premium Engine Coolant	E2FZ-19549-AA (in Canada, Motorcraft CXC-8-B)	ESE-M97B44-A
Power steering fluid	Motorcraft MERCON® ATF	XT-2-QDX	MERCON®

Capacities and specifications

Item	Ford Part Name or equivalent	Ford Part Number	Ford Specification
Windshield washer fluid	Ultra-clear Windshield Washer Concentrate	C9AZ-19550-AC	ESR-M17P5-A

¹ Use only brake fluids certified to meet Ford specifications. DOT 3 fluid is recommended. However, if DOT 3 is not available, DOT 4 fluid can be used.

ENGINE DATA

Engine	4.6L DOHC V8 engine
Cubic inches	281
Recommended fuel	91 octane
Firing order	1-3-7-2-6-5-4-8
Spark plug gap	1.3-1.4 mm (0.052-0.056 inch)
Ignition system	Coil on plug
Compression ratio	9.8:1

VEHICLE DIMENSIONS

Vehicle dimensions	mm (in)
(1) Overall length	5 294.7 (208.4)
(2) Overall width	1 870.3 (73.6)
(3) Overall height	1 421.9 (55.9)
(4) Wheelbase	2 769.8 (109.0)
(5) Track - Front	1 600.2 (63.0)
(5) Track - Rear	1 562.1 (61.5)

Capacities and specifications

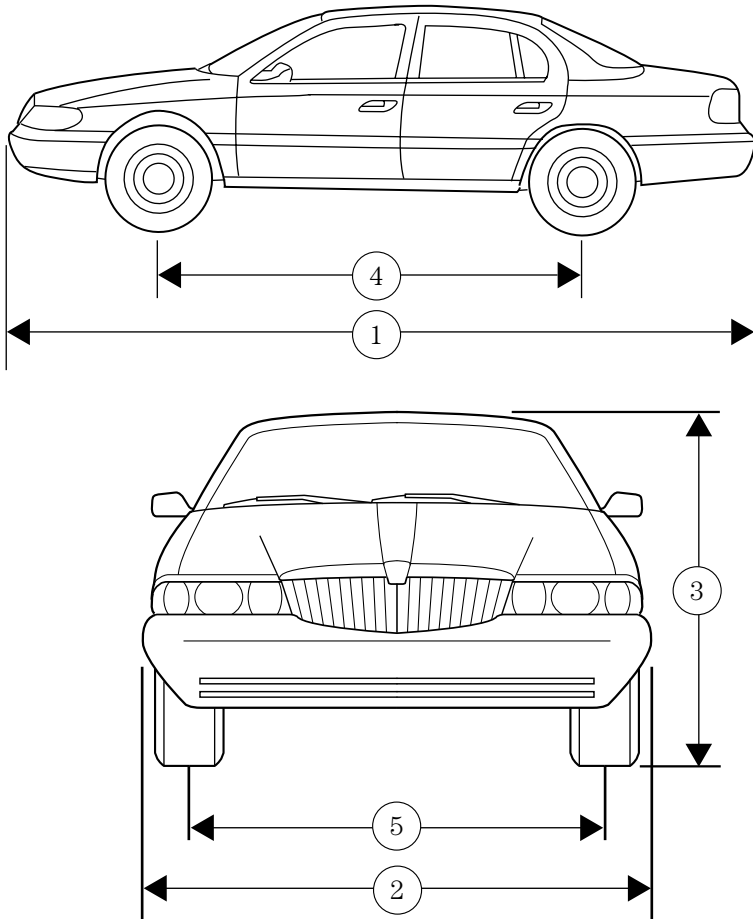

Capacities and specifications

IDENTIFYING YOUR VEHICLE

Certification label

The National Highway Traffic Safety Administration Regulations require that a Certification Label be affixed to a vehicle and prescribe where the Certification Label may be located. The Certification Label is located on the front door latch pillar on the driver's side.

MFD. BY FORD MOTOR CO. IN U.S.A.			
DATE: XXXXX	GVWR: XXXXX LB/ XXXXX KG		
FGAWR: XXXXX/XXXXXXXX	RGAWR: XXXXX/XXXXXXXX		
THIS VEHICLE CONFORMS TO ALL APPLICABLE FEDERAL MOTOR VEHICLE SAFETY STANDARDS IN EFFECT ON THE DATE OF MANUFACTURE SHOWN ABOVE.			
VIN: XXXXXXXXXXXXXXXXXXXX	TYPE: XXXXXXXXXXXXXXXXXXXX		
			
MAXIMUM LOAD=OCCUPANTS + LUGGAGE=XXXKG/XXXLB			
OCCUPANTS: X TOTAL X FR X 2ND X RR OCCUPANTS LUGGAGE			
XX XXXKG/XXXLB			
X XXXKG/XXXLB			
TIRE: XXXX/XXXX XXX			
PRESSURE (FR) XXX kPa/33 PSI COLD			
PRESSURE (RR) XXX kPa/33 PSI COLD			
TRAILER TOWING: SEE OWNER GUIDE			
EXT PNT: XXXXXX XXXXXX	RC: XX	DSO: XXXX	F0000
BAR INT TR TP/PS R	AXLE TR SPR	T0000	
X XX XXX X XX X XXXX	UTC VFOHT-15294A10-GA		

Vehicle identification number

The vehicle identification number is attached to a metal tag and is located on the driver side instrument panel. (Please note that in the graphic XXXX is representative of your vehicle identification number.)

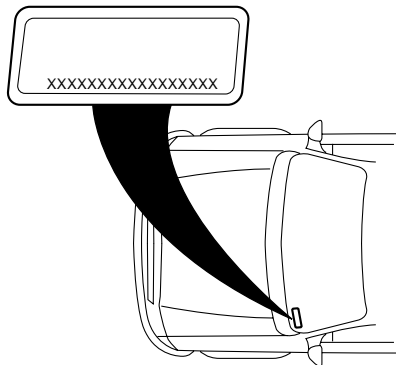

Engine number

The engine number (the last eight numbers of the vehicle identification number) is stamped on the engine block, transmission, frame and transfer case (if equipped).

Customer assistance

Ford Extended Service Plan

You can get more protection for your new car or light truck by purchasing Ford Extended Service Plan (Ford ESP) coverage. Ford ESP is an optional service contract which is backed by Ford Motor Company or Ford Motor Service Company (in the U.S.) and Ford of Canada (in Canada). It provides the following:

- benefits during the warranty period depending on the plan you purchase (such as: reimbursement for rentals; coverage for certain maintenance and wear items)
- protection against repair costs after your Bumper to Bumper Warranty expires

You may purchase Ford ESP from any participating Ford and Lincoln/Mercury and Ford of Canada dealer. There are several plans available in various time, distance and deductible combinations which can be tailored to fit your own driving needs. Ford ESP also offers reimbursement benefits for towing and rental coverage. (In Hawaii, rules vary. See your dealer for details.)

When you buy Ford ESP, you receive Peace-of-Mind protection throughout the United States and Canada, provided by a network of more than 5,000 participating Ford or Lincoln/Mercury and Ford of Canada dealers.

If you did not take advantage of the Ford Extended Service Plan at the time of purchasing your vehicle, you may still be eligible. Please contact your dealer for further information. Since this information is subject to change, please ask your dealer for complete details about Ford Extended Service Plan coverage options.

Getting the service you need

At home

Ford Motor Company and Ford of Canada have authorized dealerships to service your vehicle. When you need warranty repairs your selling dealer would like you to return to it for that service, but you may also take your vehicle to another Ford Motor Company dealership authorized for warranty repairs. Certain warranty repairs require special training though, so not all dealers are authorized to perform all warranty repairs. That means that depending on the warranty repair needed, the vehicle may need to be taken to another dealer. If a particular dealership can not assist you, then contact the Customer Assistance Center.

Customer assistance

If you have questions or concerns, or are unsatisfied with the service you are receiving, follow these steps:

1. Contact your Sales Representative or Service Advisor at your selling/servicing dealership.
2. If your inquiry or concern remains unresolved, contact the Sales Manager or Service Manager at the dealership.
3. If the inquiry or concern cannot be resolved at the dealership level, please contact the Ford Customer Assistance Center.

Ford Motor Company and Ford of Canada dealerships also carry quality parts and accessories, providing you with equipment reliability.

Away from home

If you own a Ford or Mercury vehicle and are away from home when your vehicle needs service, or if you need more help than the dealership could provide, after following the steps described above, contact the Ford Customer Assistance Center to find an authorized dealership to help you. In the United States:

Ford Motor Company
Customer Assistance Center
16800 Executive Plaza Drive
P.O. Box 6248
Dearborn, Michigan 48121
1-800-392-3673 (FORD)
(TDD for the hearing impaired: 1-800-232-5952)

In Canada:
Customer Assistance Centre
Ford Motor Company of Canada, Limited
P.O. Box 2000
Oakville, Ontario L6J 5E4
1-800-565-3673 (FORD)

Customer assistance

If you own a Lincoln vehicle and are away from home when your vehicle needs service, or if you need more help than the dealership could provide, after following the steps described above, contact the Ford Customer Assistance Center to find an authorized dealership to help you. In the United States:

Ford Motor Company
Customer Assistance Center
16800 Executive Plaza Drive
P.O. Box 6248
Dearborn, Michigan 48121
1-800-521-4140
(TDD for the hearing impaired: 1-800-232-5952)

In Canada:
Customer Assistance Centre
Ford Motor Company of Canada, Limited
P.O. Box 2000
Oakville, Ontario L6J 5E4
1-800-565-3673 (FORD)

In order to help you service your Ford or Lincoln Mercury vehicle, please have the following information available when contacting a Customer Assistance Center:

- Your telephone number (home and business)
- The name of the dealer and the city where the dealership is located
- The year and make of your vehicle
- The date of vehicle purchase
- The current odometer reading
- The vehicle identification number (VIN)

If you still have a complaint involving a warranty dispute, you may wish to contact the Dispute Settlement Board (U.S.) or the Mediation/ Arbitration Program (Canada).

In some states (in the U.S.) you must directly notify Ford in writing before pursuing remedies under your state's warranty laws. Ford is also allowed a final repair attempt in some states.

In the United States, a warranty dispute must be submitted to the Dispute Settlement Board before taking action under the Magnuson-Moss Warranty Act, or to the extent allowed by state law, before pursuing replacement or repurchase remedies provided by certain state laws. This

Customer assistance

dispute handling procedure is not required prior to enforcing state created rights or other rights which are independent of the Magnuson-Moss Warranty Act or state replacement or repurchase laws.

THE DISPUTE SETTLEMENT BOARD (U.S. ONLY)

The Dispute Settlement Board is:

- an independent, third-party arbitration program for warranty disputes
- available free to owners and lessees of qualifying Ford Motor Company vehicles

The Dispute Settlement Board may not be available in all states. Ford Motor Company reserves the right to change eligibility limitations, modify procedures and/or to discontinue this service without notice and without incurring obligations per applicable state law.

What kinds of cases does the Board review?

Unresolved warranty repair concerns or vehicle performance as designed concerns on Ford and Lincoln Mercury cars and Ford and Lincoln Mercury light trucks which are within the terms of any applicable written new vehicle warranty are eligible for review, except those involving:

- a non-Ford product
- a non-Ford dealership
- sales disputes between customer and dealer except those associated with warranty repairs or concerns with the vehicle's performance as designed
- a request for reimbursement of consequential expenses unless a service or product concern is being reviewed
- items not covered by the New Vehicle Limited Warranty (including maintenance and wear items)
- alleged personal injury/property damage claims
- cases currently in litigation
- vehicles not used primarily for family, personal or household purposes (except in states where the Dispute Settlement Board is required to review commercial vehicles)
- vehicles with non-U.S. warranties

Customer assistance

Concerns are ineligible for review if the New Vehicle Limited Warranty has expired at receipt of your application and, in certain states eligibility is dependent upon the customer's possession of the vehicle.

Eligibility may differ according to state law. For example, see the unique brochures for California, West Virginia, Georgia and Wisconsin purchasers/lessees.

Board membership

The Board consists of:

- three consumer representatives
- a Ford or Lincoln Mercury dealership representative

Consumer candidates for Board membership are recruited and trained by an independent consulting firm. The dealership Board member is chosen from Ford and Lincoln Mercury dealership management, recognized for their business leadership qualities.

What the Board needs

To have your case reviewed you must complete the application in the DSB brochure and mail it to the address provided on the application form. Some states will require you to use certified mail, with return receipt requested.

Your application is reviewed and, if it is determined to be eligible, you will receive an acknowledgment indicating:

- the file number assigned to your application
- the toll-free phone number of the DSB's independent administrator

Your dealership and a Ford Motor Company representative will then be asked to submit statements.

To properly review your case, the Board needs the following information:

- legible copies of all documents and maintenance or repair orders relevant to the case
- the year, make, model, and Vehicle Identification Number (VIN) listed on your vehicle ownership license
- the date of repair(s) and mileage at the time of occurrence(s)
- the current mileage
- the name of the dealer(s) who sold or serviced the vehicle
- a brief description of your unresolved concern

Customer assistance

- a brief summary of the action taken by the dealer(s) and Ford Motor Company
- the names (if known) of all the people you contacted at the dealership(s)
- a description of the action you expect to resolve your concern

You will receive a letter of explanation if your application does not qualify for Board review.

Oral presentations

If you would like to make an oral presentation, indicate YES to question #6 on the application. While it is your right to make an oral presentation before the Board, this is not a requirement and the Board will decide the case whether or not an oral presentation is made. Oral presentation may be requested by the Board as well.

Making a decision

Board members review all available information related to each complaint, including oral presentations, and arrive at a fair and impartial decision. Board review may be terminated at any time by either party.

Every effort is made to decide the case within 40 days of the date that all requested information is received by the Board. Since the Board generally meets once a month, it may take longer for the Board to consider some cases.

After a case is reviewed, the Board mails you a decision letter and a form on which to accept or reject the Board's decision. The decisions of the Board are binding on Ford (and, in some cases, on the dealer) but not on consumers who are free to pursue other remedies available to them under state or federal law.

To Request a DSB Brochure/Application

For a brochure/application, speak to your dealer or write/call to the Board at the following address/phone number:

Dispute Settlement Board
P.O. Box 5120
Southfield, MI 48086-5120
1-800-428-3718

Customer assistance

You may also contact the North American Customer Assistance Center at 1-800-392-3673 (Ford), TDD for the hearing impaired: 1-800-232-5952 or by writing to the Center at the following address:

Ford Motor Company
Customer Assistance Center
16800 Executive Plaza Drive
P.O. Box 6248
Dearborn, Michigan 48121

UTILIZING THE MEDIATION/ARBITRATION PROGRAM (CANADA ONLY)

In those cases where you continue to feel that the efforts by Ford and the dealer to resolve a factory-related vehicle service concern have been unsatisfactory, Ford of Canada participates in an impartial third party mediation/arbitration program administered by the Canadian Motor Vehicle Arbitration Plan (CAMVAP).

The CAMVAP program is a straight-forward and relatively speedy alternative to resolve a disagreement when all other efforts to produce a settlement have failed. This procedure is without cost to you and is designed to eliminate the need for lengthy and expensive legal proceedings.

In the CAMVAP program, impartial third-party arbitrators conduct hearings at mutually convenient times and places in an informal environment. These impartial arbitrators review the positions of the parties, make decisions and, when appropriate, render awards to resolve disputes. CAMVAP decisions are fast, fair, and final; the arbitrator's award is binding both to you and Ford of Canada.

CAMVAP services are available in all territories and provinces, except Quebec. For more information, without charge or obligation, call your CAMVAP Provincial Administrator directly at 1-800-207-0685.

GETTING ASSISTANCE OUTSIDE THE U.S. AND CANADA

Before exporting your vehicle to a foreign country, contact the appropriate foreign embassy or consulate. These officials can inform you of local vehicle registration regulations and where to find unleaded fuel.

If you cannot find unleaded fuel or can only get fuel with an anti-knock index lower than is recommended for your vehicle, contact a district or owner relations/customer assistance office.

Customer assistance

The use of leaded fuel in your vehicle without proper conversion may damage the effectiveness of your emission control system and may cause engine knocking or serious engine damage. Ford Motor Company/Ford of Canada is not responsible for any damage caused by use of improper fuel.

In the United States, using leaded fuel may also result in difficulty importing your vehicle back into the U.S.

If your vehicle must be serviced while you are traveling or living in Central or South America, the Caribbean, or the Middle East, contact the nearest Ford dealership. If the dealership cannot help you, write or call:

FORD MOTOR COMPANY
WORLDWIDE DIRECT MARKET OPERATIONS
1555 Fairlane Drive
Fairlane Business Park #3
Allen Park, Michigan 48101
U.S.A.
Telephone: (313) 594-4857
FAX: (313) 390-0804

If you are in another foreign country, contact the nearest Ford dealership. If the dealership employees cannot help you, they can direct you to the nearest Ford affiliate office.

If you buy your vehicle in North America and then relocate outside of the U.S. or Canada, register your vehicle identification number (VIN) and new address with Ford Motor Company Worldwide Direct Market Operations.

FORD CAR CARE PRODUCTS FOR YOUR VEHICLE

Ford has many quality products available from your dealer to clean your vehicle and protect its finishes. These quality products have been specifically engineered to fulfill your automotive needs; they are custom designed to complement the style and appearance of your vehicle. Each product is made from high quality materials and that meet or exceed Ford's rigid specifications. For best results, use the following or products of equivalent quality:

Ford Custom Clearcoat Polish*

Ford Custom Silicone Gloss Polish

Ford Custom Vinyl Protectant* (not available in Canada)

Motorcraft Vinyl Conditioner (Canada only)

Customer assistance

Ford Deluxe Leather and Vinyl Cleaner (not available in Canada)

Motorcraft Vinyl Cleaner (Canada only)

Ford Extra Strength Tar and Road Oil Remover* (not available in Canada)

Ford Extra Strength Upholstery Cleaner (Canada only)

Ford Extra Strength Upholstery Cleaner (not available in Canada)

Ford Metal Surface Cleaner

Ford Multi-Purpose Cleaner*

Motorcraft Car Wash Concentrate

Motorcraft Carlite Glass Cleaner

Ford Spot and Stain Remover*

Ford Super Premium Tire and Trim Dressing

Ford Triple Clean

Ford Ultra-Clear Spray Glass Cleaner (not available in Canada)

* May be sold with the Motorcraft name

FORD ACCESSORIES FOR YOUR VEHICLE

A wide selection of Ford accessories are available for your vehicle through your local authorized Ford, Lincoln Mercury or Ford of Canada dealer. These quality accessories have been specifically engineered to fulfill your automotive needs; they are custom designed to complement the style and aerodynamic appearance of your vehicle. In addition, each accessory is made from high quality materials and meets or exceeds Ford's rigid engineering and safety specifications. Ford accessories are warranted for up to 12 months or 20 000 km (12 000 miles) on all cars and light trucks and 12 months with unlimited distance on medium/heavy duty trucks unless the accessory is installed on a new vehicle, then the warranty becomes the balance of the new vehicle's warranty or the accessories warranty, whichever is greater. See your dealer for complete warranty information and availability.

Not all accessories are available for all models.

Vehicle Security

Styled wheel protector locks

Vehicle security systems

Customer assistance

Comfort and convenience

Cargo nets

Cargo organizers

Engine block heaters

Luggage presenter

Travel equipment

Heavy-duty battery

Inside mirror, electrochromic with compass (with and without temperature display)

Protection and appearance equipment

Air bag anti-theft locks

Carpet floor mats (standard and premium)

Cleaners, waxes and polishes

Flat splash guards

Lubricants and oils

Molded splash guards

Molded vinyl floor mats

Touch-up paint

Universal floor mats

For maximum vehicle performance, keep the following information in mind when adding accessories or equipment to your vehicle:

- When adding accessories, equipment, passengers and luggage to your vehicle, do not exceed the total weight capacity of the vehicle or of the front or rear axle (GVWR or GAWR as indicated on the Safety compliance certification label). Consult your dealer for specific weight information.
- The Federal Communications Commission (FCC) and Canadian Radio Telecommunications Commission (CRTC) regulate the use of mobile communications systems - such as two-way radios, telephones and theft alarms - that are equipped with radio transmitters. Any such equipment installed in your vehicle should comply with FCC or CRTC regulations and should be installed only by a qualified service technician.

Customer assistance

- Mobile communications systems may harm the operation of your vehicle, particularly if they are not properly designed for automotive use or are not properly installed. When operated, such systems may cause the engine to stumble or stall. In addition, such systems may be damaged or their performance may be affected by operating your vehicle. (Citizens band [CB] transceivers, garage door openers and other transmitters with outputs of five watts or less will not ordinarily affect your vehicle's operation.)
- Ford cannot assume responsibility for any adverse effects or damage that may result from the use of such equipment.

ORDERING ADDITIONAL OWNER'S LITERATURE

To order the publications in this portfolio:

Make checks payable to:

HELM, INCORPORATED

P.O. Box 07150

Detroit, Michigan 48207

For a free publication catalog, order toll free: 1-800-782-4356

Monday-Friday 8:00 a.m. - 6:00 p.m. EST,
for credit card holders only

Obtaining a French owner's guide

French Owner's Guides can be obtained from your dealer or by writing to Ford Motor Company of Canada, Limited, Service Publications, P.O. Box 1580, Station B, Mississauga, Ontario L4Y 4G3.

Reporting safety defects

REPORTING SAFETY DEFECTS (U.S. ONLY)

If you believe that your vehicle has a defect that could cause a crash, or could cause injury or death, you should immediately inform the National Highway Traffic Safety Administration (NHTSA) in addition to notifying Ford Motor Company.



If NHTSA receives similar complaints, it may open an investigation, and if it finds that a safety defect exists in a group of vehicles, it may order a recall and remedy campaign. However, NHTSA cannot become involved in individual problems between you, your dealer or Ford Motor Company.

To contact NHTSA, you may either call the Auto Safety Hotline toll-free at 1-800-424-9393 (202-366-0123 in the Washington D.C. area) or write to:

NHTSA
U.S. Department of Transportation
400 Seventh Street
Washington D.C. 20590

You can also obtain other information about motor vehicle safety from the Hotline.

Index

- Accessory delay76
- Air bag supplemental restraint system104,105,109
 - and child safety seats106
 - description105,109
 - disposal112
 - driver air bag107,110
 - indicator light9,108,111
 - operation107,110
 - passenger air bag107,110
 - side air bag109
- Air cleaner filter209
- Air conditioning24
 - automatic temperature control system24
- Air filter, cabin179
- Air suspension129
 - description129
- Antifreeze
(see Engine coolant)169
- Anti-lock brake system
(see Brakes)125,126
- Anti-theft system79
 - arming the system79
 - disarming a triggered system ..80
- Audio system (see Radio)30
- Automatic transaxle130
 - driving with132
 - fluid, adding174
 - fluid, checking174
 - fluid, refill capacities209
 - fluid, specification211
- Axle
lubricant specifications210
- Battery177
 - acid, treating emergencies177
 - charging system
 - warning light11
 - jumping a disabled battery156
 - maintenance-free177
 - replacement, specifications ...209
 - servicing177
- Belt minder100
- Brakes125
 - anti-lock125,126
 - anti-lock brake system (ABS) warning light10,126
 - brake warning light10
 - fluid, checking and adding168
 - fluid, refill capacities209
 - fluid, specifications210,211
 - lubricant specifications ...210,211
 - shift interlock130
- Break-in period3
- Capacities for refilling fluids ...209
- CD changer42
- Certification Label213
- Child safety restraints112
 - child safety belts112
- Child safety seats113
 - attaching with tether straps ..117
 - in front seat115
 - in rear seat115
- Cleaning your vehicle204
 - engine compartment206
 - exterior205
 - exterior lamps206
 - instrument panel207
 - instrument panel lens207
 - interior207,208
 - mirrors205
 - plastic parts205
 - safety belts208
 - washing204
 - waxing204
 - wheels205
 - windows208
 - wiper blades206
 - woodtone trim208
- Climate control (see Air conditioning or Heating)24
- Clock30
- Compass, electronic69
 - calibration71,73

- set zone adjustment70,72
- Console78
 - overhead54
- Controls
 - power seat92
 - steering column48
- Coolant
 - checking and adding169
 - refill capacities173,209
 - specifications210,211
- Cruise control
 - (see Speed control)49
- Customer Assistance141
 - Ford accessories
 - for your vehicle221
 - Ford Extended
 - Service Plan214
 - Getting assistance outside
 - the U.S. and Canada220
 - Getting roadside assistance ...141
 - Getting the
 - service you need214
 - Ordering additional
 - owner's literature224
 - The Dispute Settlement
 - Board217
 - Utilizing the Mediation/
 - Arbitration Program220
- Daytime running lamps
 - (see Lamps)22
- Defrost
 - rear window29
- Dipstick
 - automatic
 - transmission fluid174
 - engine oil165
- Doors
 - lubricant specifications210
- Driving under special
 - conditions
 - through water135
- Emergencies, roadside
 - jump-starting156
- Emission control system195
- Engine211
 - check engine/service engine
 - soon light8
 - cleaning206
 - coolant169
 - idle speed control177
 - lubrication
 - specifications210,211
 - refill capacities209
 - service points164
 - starting after a collision142
- Engine block heater122
- Engine oil165
 - change oil soon warning,
 - message center165
 - checking and adding165
 - dipstick165
 - filter, specifications167,209
 - recommendations167
 - refill capacities209
 - specifications210,211
- Exhaust fumes123
- Floor mats79
- Fluid capacities209
- Fuel187
 - calculating
 - fuel economy20,21,192
 - cap189
 - capacity209
 - choosing the right fuel190
 - comparisons with EPA fuel
 - economy estimates195
 - detergent in fuel191
 - filling your vehicle
 - with fuel187,189,192
 - filter, specifications191,209
 - fuel filler door override78
 - fuel filler door release78
 - fuel pump shut-off switch142

Index

- gauge12
- improving fuel economy192
- octane rating190,211
- quality190
- running out of fuel191
- safety information relating to
automotive fuels187
- Fuses143,144
- Garage door opener65
- Gas cap (see Fuel cap)189
- Gas mileage
(see Fuel economy)192
- Gauges12
 - engine coolant
temperature gauge13
 - fuel gauge12
 - odometer13
 - speedometer13
 - tachometer13
- GAWR
(Gross Axle Weight Rating)135
 - definition135
 - driving with a heavy load135
 - location135
- GVWR (Gross
Vehicle Weight Rating)135
 - calculating135
 - definition135
 - driving with a heavy load135
 - location135
- Hazard flashers142
- Head restraints92
- Headlamps22
 - aiming201,202,203
 - autolamp system23
 - bulb specifications201
 - daytime running lights22
 - flash to pass23
 - high beam10,22
 - replacing bulbs197
 - turning on and off11,22
 - warning chime12
- Heating24
- HomeLink universal
transceiver (see Garage
door opener)65,66,67,68
- Hood163
- Ignition211
 - positions of the ignition46
- Infant seats
(see Safety seats)113
- Inspection/maintenance
(I/M) testing196
- Instrument panel
 - cleaning207
 - cluster8,207
 - lighting up
panel and interior23
 - location of components8
- Jump-starting your vehicle156
- Keyless entry system85
 - autolock88
 - keypad85
 - programming entry code86
- Keys47
 - key in ignition chime12
 - positions of the ignition46
- Lamps
 - autolamp system23
 - bulb replacement
specifications chart201
 - cargo lamps23
 - daytime running light22
 - headlamps22
 - headlamps, flash to pass23
 - instrument panel, dimming23
 - interior lamps53,54,200
 - replacing bulbs ..196,197,199,200
- Lane change indicator
(see Turn signal)48
- Lights, warning and indicator8
 - air bag9
 - anti-lock brakes (ABS)10,126
 - brake10

- charging system11
- high beam10
- oil pressure11
- safety belt9
- service engine soon8
- traction control active11
- turn signal indicator10
- Load limits135
 - GAWR135
 - GVWR135
 - trailer towing135
- Locks
 - autolock88
 - childproof77
 - doors74
- Lubricant specifications ...210,211
- Lug nuts, anti-theft155
- Lumbar support, seats94
- Message center14,16,20
 - air leveling disabled14
 - air ride switch off14
 - check air ride system14
 - check air suspension14
 - menu button19
 - reset button20
 - system check button16
 - warning messages17
- Mirrors65
 - automatic dimming
 - rearview mirror73
 - cleaning205
 - heated77
 - programmable memory84
 - side view mirrors (power)76
- Moon roof65
- Motorcraft parts191,209
- Octane rating190
- Odometer13
- Oil (see Engine oil)165
- Overdrive131
- Panic alarm feature,
 - remote entry system82
- Parking brake126
- Parts (see Motorcraft parts) ...209
- Power distribution box
 - (see Fuses)151
- Power door locks74
- Power steering128,129
 - fluid, checking and adding174
 - fluid, refill capacity209
 - fluid, specifications210,211
- Radio30
- Relays143,152
- Remote entry system81,82
 - illuminated entry84
 - locking/unlocking doors81
 - opening the trunk82
 - panic alarm82
 - replacement/additional
 - transmitters83
 - replacing the batteries82
- Safety belts (see Safety restraints)12,95,96,97,98
- Safety defects, reporting225
- Safety restraints95,96,97,98
 - belt minder100
 - cleaning
 - the safety belts104,208
 - extension assembly99
 - for adults96,97,98
 - for children112
 - lap belt99
 - warning light
 - and chime9,11,100
- Safety seats for children113
- Seat belts
 - (see Safety restraints)95
- Seats92
 - child safety seats113
 - cleaning207,208
 - easy access/easyout feature95
 - heated94
 - memory seat84

Index

- SecuriLock passive anti-theft system88,89,90
- Servicing your vehicle162
- Spark plugs, specifications209,211
- Specification chart, lubricants210,211
- Speed control49
- Speedometer13
- Starting your vehicle120,122
 - jump starting156
- Steering
 - speed sensitive129
- Steering wheel
 - controls48
 - tilting53
- Tachometer13
- Tilt steering wheel53
- Tires152,181,182,183,184,185
 - changing152,153
 - checking the pressure185
 - replacing186
 - rotating185
 - snow tires and chains186
 - tire grades184
 - treadwear184
- Towing185
 - recreational towing140
- wrecker161
- Traction control127
 - off light11
- Transaxle
 - automatic operation130
 - fluid, refill capacities209
 - lubricant specifications211
- Transmission
 - fluid, checking and adding (automatic)174
 - lubricant specifications210
- Trunk91
 - remote release77,82
- Turn signal10,48
- Vehicle dimensions211
- Vehicle Identification Number (VIN)213
- Vehicle loading135
- Ventilating your vehicle124
- Warning chimes11,12
- Warning lights (see Lights)8
- Washer fluid169
- Water, Driving through135
- Windows
 - power75
- Windshield washer fluid and wipers
 - checking and adding fluid169
 - checking and cleaning181
 - operation47
 - replacing wiper blades181
- Wrecker towing161

Filling station information

Item	Information
Required fuel	Unleaded fuel only - 91 octane
Fuel tank capacity	75.7L (20.0 gallons)
Engine oil capacity (includes filter change)	5.7L (6.0 quarts). Use Motorcraft SAE 5W-30 Super Premium Motor Oil, Ford specification WSS-M2C153-G.
Automatic transaxle fluid capacity ¹	13.0L (13.7 quarts). Use Motorcraft Mercon [®] V ATF.
Tire size and pressure	Refer to the Certification Label inside of driver's door.
Hood release	Pull handle under the left side of the instrument panel.
Coolant capacity ²	15.0L (15.8 quarts)
Power steering fluid capacity	Fill to line on reservoir. Use Motorcraft MERCON [®] ATF.
Windshield washer fluid	3.4L (3.6 quarts). Use Ultra-Clear Windshield Washer Concentrate.

¹ Ensure the correct automatic transmission fluid is used. Transmission fluid requirements are indicated on the dipstick or on the dipstick handle. MERCON[®] and MERCON[®] V are not interchangeable. DO NOT mix MERCON[®] and MERCON[®] V. Refer to your Scheduled Maintenance Guide to determine the correct service interval.

² Use Ford Premium Engine Coolant (green in color). DO NOT USE Ford Extended Life Engine Coolant (orange in color). Refer to *Adding engine coolant*, in the *Maintenance and Care* chapter.