

SMART | ACTIVE | SOUND

(((AE)))  
ACOUSTIC ENERGY

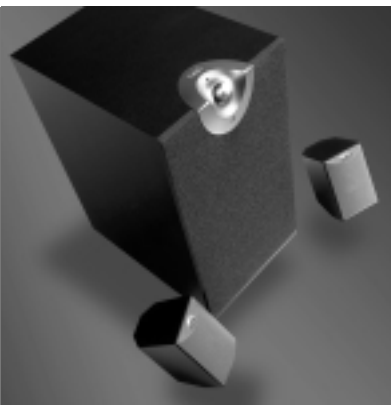

OWNERS  
MANUAL



## WARNING

To reduce the risk of fire or electric shock, do not expose this system to rain or moisture.

## CAUTION

To reduce the risk of shock, do not remove the cover of this system. There are no user-serviceable parts inside. Refer servicing to qualified service personnel.

The **CAUTION** marks shown on this page are located on the back of your system.



The lightning flash, with arrowhead symbol within an equilateral triangle, is intended to alert the user to the presence of uninsulated "dangerous voltage" within the system enclosure that may be of sufficient magnitude to constitute a risk of electric shock.



The exclamation point within an equilateral triangle as marked on the system is intended to alert the user to the presence of important operating and maintenance instructions in this owner's guide.

### CAUTION

Risk of electrical shock  
**Do not open**

### ATTENTION

Risque de choc électrique  
**Ne pas ouvrir**

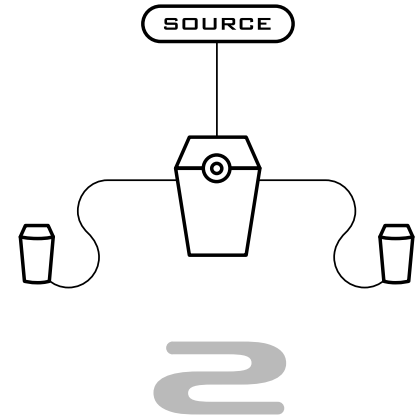

Comprises an active sub woofer with system volume control plus two satellites.

You can hook your sources up to the low-level RCA phono connections on the back of the Aego sub woofer or, alternatively, use the stereo mini-jack located on the sub woofer's front-panel.

To connect Aego2 to an existing hi-fi amplifier use the adaptor lead supplied from your amplifier speaker outputs.

Note that the Aego2 system contains four channels of amplification as standard - left, right, sub woofer and an optional centre-channel for use with the Aego3 and 5 systems.

## POSITIONING

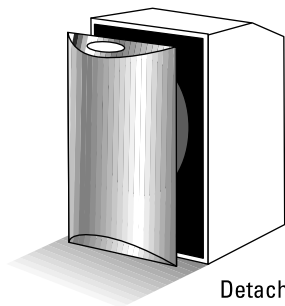
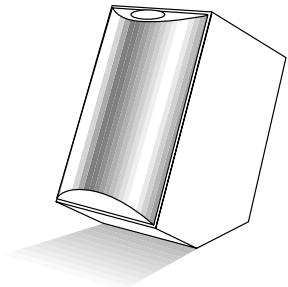

Detachable grille  
can rotate to suit  
speaker orientation.

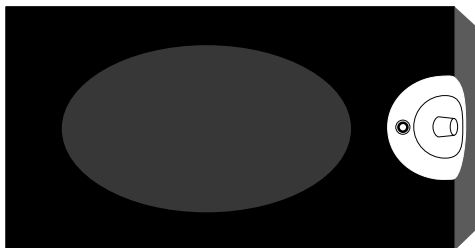
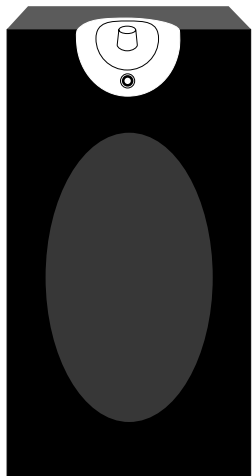
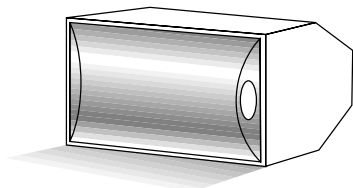

## FIXING

\* Not supplied

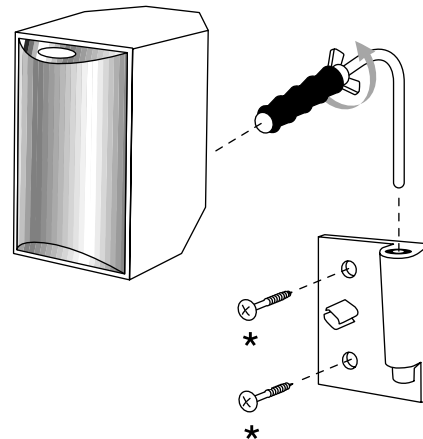

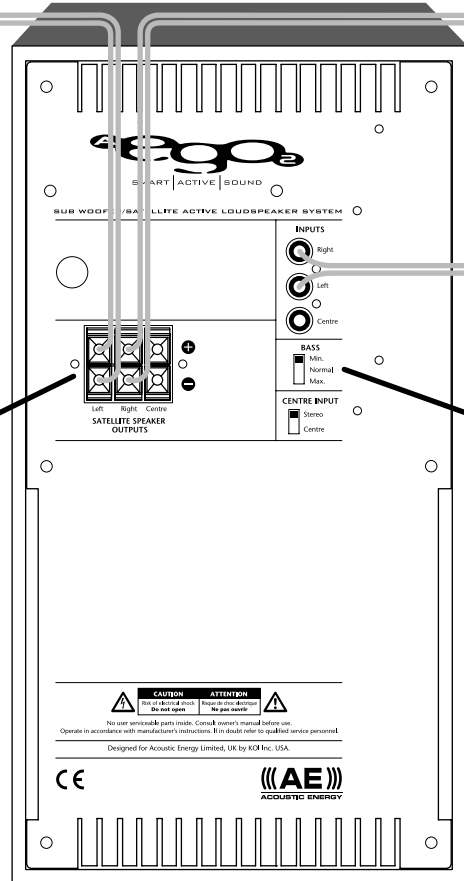
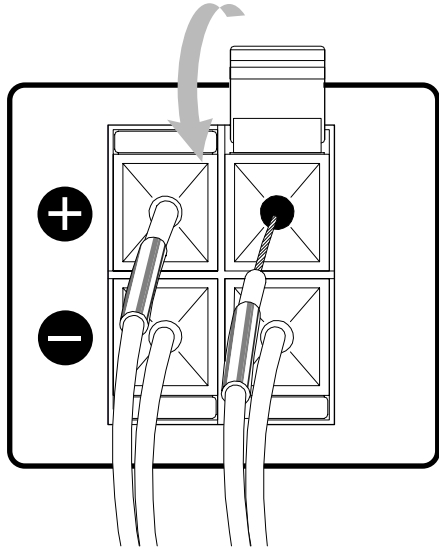
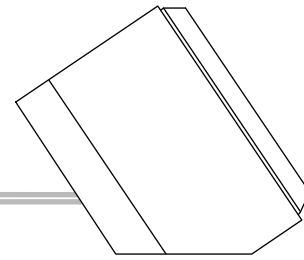
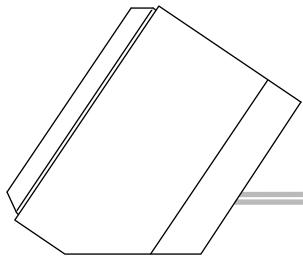

**INPUTS**

Right

Left

Centre

**BASS**

Min.

Normal

Max.

**CENTRE INPUT**

Stereo

Centre

SATELLITE SPEAKER OUTPUTS

Left Right Centre

**CAUTION** Risk of electrical shock. Do not open. **ATTENTION** Please do not use accessories that are not approved. No user serviceable parts inside. Consult owner's manual before use. Operate in accordance with manufacturer's instructions. If in doubt refer to qualified service personnel.

Designed for Acoustic Energy Limited, UK by AOR Inc, USA.

CE **AE** ACoustic Energy

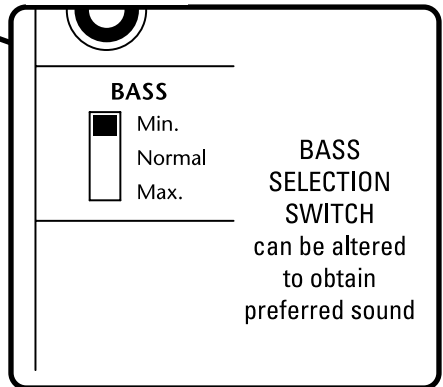

**BASS**

Min.

Normal

Max.

**BASS SELECTION SWITCH**  
can be altered to obtain preferred sound

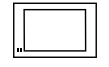

TV



GAMES



HI-FI



MP3



PC



PERSONAL CD



DVD



MINI DISC



TV



GAMES



HI-FI



MP3



PC



PERSONAL CD



DVD



MINI DISC

### TIP:

Where the source has a variable volume setting, it is suggested the volume control on the Aego2 Sub woofer be set on or near maximum. This way, the input volume can be varied from the amplifier utilising existing controls and remote control devices.

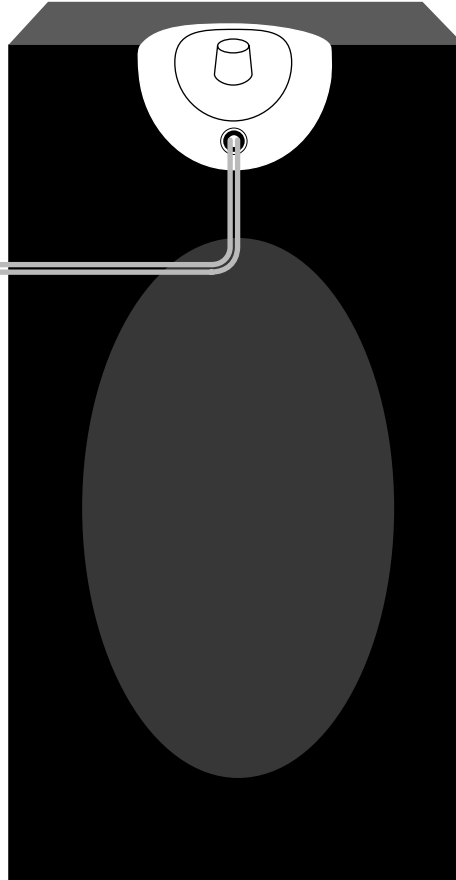

## HIGH LEVEL INPUT FROM A POWER AMPLIFIER

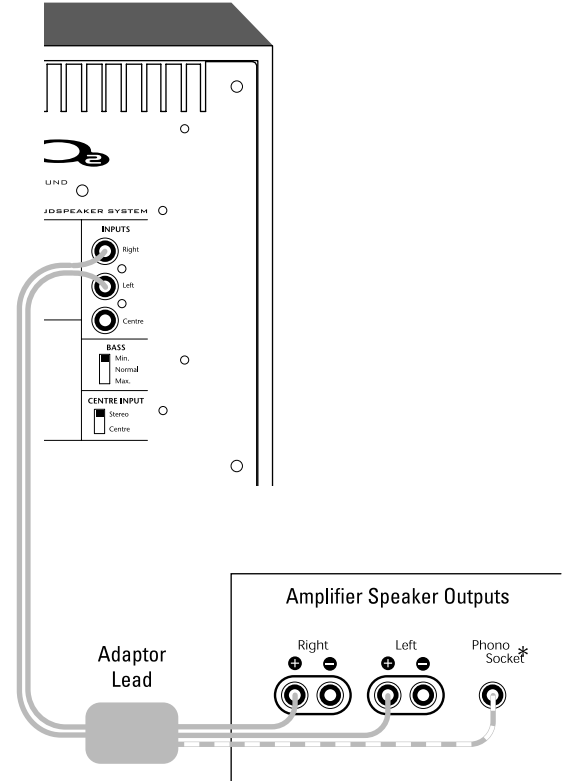

\* You can use **ANY** available Phono/RCA socket



## UPGRADE FACILITIES

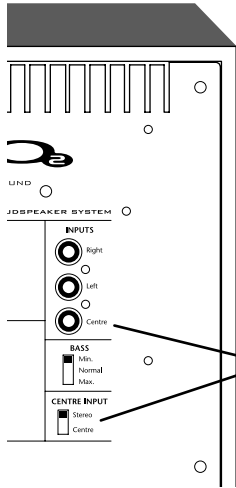

For use with  
AEGO3 and  
AEGO5

# 3

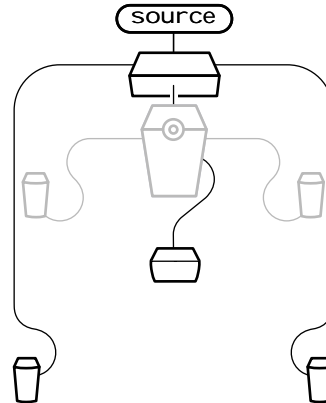

(Due Summer 2001)

An add-on package designed to upgrade Aego2 systems for full six-channel home cinema/audio use. The package includes three extra Aego satellite speakers (centre channel plus two surrounds) plus a high quality standalone Dolby® Digital/DTS processor with integrated two-channel amplifier.

# 5

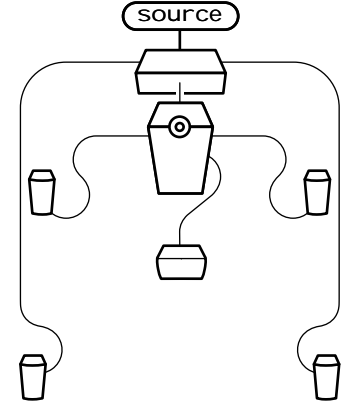

(Due Summer 2001)

Combine the Aego2 and Aego3 packages and you have the Aego5. Offering full, straight out of the box compatibility with digital multi-channel audio systems, Aego5 will be the simplest route to unobtrusive, high performance multi-channel home cinema and audio.

## WARRANTY

Your Acoustic Energy loudspeakers are guaranteed against original defects in materials, manufacture and workmanship for 1 year from the date of purchase. Please retain all original packaging materials for possible future use.

Under this warranty Acoustic Energy agrees to repair any defect or, at the company's discretion, replace the faulty component(s) without charge for parts and labour. This warranty does not imply any acceptance for Acoustic Energy or its agents for consequential loss damage and specifically excludes fair wear and tear, accident misuse or unauthorised modification.

This warranty is applicable in the United Kingdom only and does not in any way limit the customer's legal rights. Claims and enquiries under the warranty for AE products purchased outside the UK should be addressed to the local importers or distributors.

If you have reason to claim under the warranty please contact your dealer in the first instance.



## TECHNICAL INFORMATION

### **SATELLITE SPEAKERS:**

A patented advanced technology driver featuring a unique heat transfer system: special high excursion suspension and a computer-designed anti-resonant cone

### **INPUTS:**

- 3 x RCA Phono - Line level
- 1 x Stereo Mini jack - Line level

### **OUTPUTS:**

- 3 x Speaker terminals

### **CONTROLS:**

- 1 x Volume / Power pot
- 1 x Bass switch (3 Position)
- 1 x Centre input switch (2 Position)

### **ACCESSORIES:**

- 2 x 5 metre Speaker cables
- 1 x 2 metre Signal input cable
- 1 x Speaker level to line level adaptor cable
- 2 x Wall brackets

### **POWER RATINGS:**

- 120V Model - 120V @ 60Hz; 80VA
- 240V Model - 140V @ 50Hz; 80VA

### **DIMENSIONS:**

- Sub Woofer - 265mm x 190mm x 350mm
- Satellites - 68mm x 103mm x 90mm

### **WEIGHT:**

- 9 Kg

### **FINISHES:**

- Black sub woofer
- Textured black satellites with silver/grey grilles

- White sub woofer
- Textured white satellites with silver/grey grilles



Designed by KOI Inc (USA) Exclusively for Acoustic Energy Limited (UK)  
Manufactured in Malaysia.

Acoustic Energy Limited, 16 Bridge Road, Cirencester, Gloucestershire GL7 1NJ. UK  
Tel: +44 (0)1285 654432 Fax: +44 (0)1285 654430

**WWW.AEGO2.COM**